

標題

MSC 99 の審議結果の紹介

ClassNK

テクニカル インフォメーション

No. TEC-1162
発行日 2018年8月24日

各位

2018年5月16日から25日にIMO(英国・ロンドン)において第99回海上安全委員会(MSC 99)が開催されました。今般、IMOよりMSC 99の議事録及び決議並びにサーキュラーが発行されたことから、次の通り同会合の情報及び審議結果をお知らせ致します。

1. 採択された条約及び関連コードの主要な改正

今回の会合で採択された主要な義務要件は以下の通りです。

(1) 旅客船の安全性強化(添付1参照)

2014年1月1日より前に建造された旅客船に対し、浸水事故に備えた復原性計算機もしくは、陸上からの支援を要求するSOLAS条約II-1章8-1規則の改正が採択されました。

適用: 2020年1月1日発効

(2) FTPコードの改正(添付2参照)

防火材料に要求される試験方法を定めた付録3の表1を、定員36人以下の旅客船にも適用するための改正が採択されました。

適用: 2020年1月1日発効

(3) GMDSSの近代化(添付1, 3, 4及び8参照)

GMDSSの近代化に伴い、インマルサットに加えて他の移動衛星サービスの利用を認めるSOLAS条約IV章、1994及び2000HSCコード、2008SPSコードと関連証書書式の改正が採択されました。

適用: 2020年1月1日発効

(4) IBCコード及びIGCコード等における適合証書書式の改正(添付5, 6, 9, 10及び11参照)

IBC, BCH, GC, IGC及びEGCコードにおいて、承認された積み付け及び復原性資料が船上に搭載されていることを確認するべき旨を明確にする適合証書書式の改正が採択されました。

適用: 2020年1月1日発効

(次頁に続く)

NOTES:

- ClassNK テクニカル・インフォメーションは、あくまで最新情報の提供のみを目的として発行しています。
- ClassNK 及びその役員、職員、代理もしくは委託事業者のいずれも、掲載情報の正確性及びその情報の利用あるいは依存により発生する、いかなる損失及び費用についても責任は負いかねます。
- バックナンバーは ClassNK インターネット・ホームページ(URL: www.classnk.or.jp)においてご覧いただけます。

(5) IMDG コードの改正(添付 7 参照)

国連による 2 年周期での「危険物輸送に関する勧告」の改正に伴う、第 39 回 IMDG コード改正が採択されました。

適用: 2020 年 1 月 1 日発効(ただし、主管庁判断により 2019 年 1 月 1 日からの早期適用が可能)

2. 承認された条約及び関連コードの主要な改正

以下の改正案が、2018 年 12 月に開催される MSC 100 にて採択される見込みです。

ESP コードの改正(添付 12 参照)

IACS の統一規則(UR) Z10 シリーズとの整合や強制適用される要件の表記変更等のための ESP コードの改正案が承認されました。今般承認された改正案及び 2019 年 2 月の SDC 6 で検討されることとなっている実質的な要件として同コードの本文中に取り込むべき脚注の見直し結果に基づき、今後 ESP コード統合版が作成される予定です。

3. 今回の会合において承認された統一解釈及びガイドラインのうち、主要なものは以下のとおりです。以下で参照されている IACS 統一解釈(UI)については、IACS ホームページ(<http://www.iacs.org.uk/>)にて公開されております。

3.1 統一解釈

(1) IGC コード 13.3.5 で規定される"each dry-docking"に関する統一解釈(添付 16 参照)

- IGC コード 13.3.5 で規定される、貨物タンクの高位液面警報に対する作動試験の実施時期に関する文言"each dry-docking"は、貨物安全構造証書及び／又は貨物安全証書の更新検査で要求される船底検査をいうことを明確にする解釈(UI GC18 関連)

(2) IGF コードに関する統一解釈(添付 17 参照)

- IGF コードに関する 4 件の統一解釈:
 - (i) 同コード 6.8.2 で規定される、液化ガス燃料タンクの基準温度から算出された値より大きい充填制限値を認めるための条件の明確化
 - (ii) 同コード 11.3.3 で規定される燃料格納設備を含む区域の防火要件における、"other rooms with high fire risk"の解釈
 - (iii) 同コード 15.3.2 で規定されるタンクコネクションスペースのビルジウェルに設置する液面計の解釈
 - (iv) 同コード 15.4.2.3 で規定される、貨物船及び旅客船の液化ガス燃料タンクの高位液面警報に対する作動試験の実施時期に関する文言"each dry-docking" の明確化(UI GF1 関連)

(次頁に続く)

3.2 ガイドライン

(1) SOLAS 条約及び関連の強制要件の改正に関するガイダンス(MSC.1/Circ.1500)の適用拡大(添付 13 及び 14 参照)

- ・ 現在 SOLAS 条約のみに適用されている 4 年毎の改正サイクルを、LL 条約、トン数条約、STCW 条約、COLREG といった、SOLAS 条約以外の安全関連要件にも適用拡大するための MSC.1/Circ.1500 の改正 (MSC.1/Circ.1500/Rev.1) 及び新規 MSC サーキュラー発行 (MSC.1/Circ.1587)。

(2) EmS ガイドの改正(添付 15 参照)

- ・ 上記 1.(5)の第 39 回 IMDG コード改正に伴い、これまで発行されている下記 7 件のサーキュラーを統合するための、危険物を運送する船舶の非常措置指針 (EmS ガイド) の改正。(MSC/Circ.1025, MSC.1/Circ.1025/Add.1, MSC.1/Circ.1262, MSC.1/Circ.1360, MSC.1/Circ.1438, MSC.1/Circ.1476, MSC.1/Circ.1522)

(3) IAMSAR マニュアルの更新(添付 18 参照)

- ・ 3 年周期で更新される IAMSAR マニュアルの 2019 年度改正版。2019 年 7 月 1 日以降に適用。

4. その他

(1) GBS(目標指向型新造船基準)適合検証ガイドラインの見直し

SOLAS 条約 II-1 章 3-10 規則に規定される GBS (Goal-based standard) により、船の長さが 150m 以上である油タンカー及びばら積貨物船*は、GBS の機能要件に適合した船級協会の規則に従って、設計・建造することが要求されます。GBS では、各船級協会の規則が GBS の機能要件に適合していることを確認するための適合監査が要求されており、GBS 適合検証ガイドライン(MSC.296(87))に基づき、IMO により初回適合監査及び定期的な適合維持監査が実施されます。

今回の会合では、前回の会合から引き続き同ガイドラインの改正案について審議が行われました。審議の結果、下記項目を含む同ガイドラインの改正案が承認されました。本改正案は次回の会合で採択される予定です。

- 適合維持監査を原則 3 年毎とすること
- 旗国若しくは船級協会が 3 年毎の適合維持監査以外に追加の監査が必要と判断し、要求した場合、IMO にて追加監査の要否が検討されること
- 改正した規則及び新しく制定した規則を 3 つのカテゴリに分類の上、カテゴリ及び規則の重要度に応じて、適合維持監査の範囲を決定すること

* 2016 年 7 月 1 日以降に建造契約が行われる船舶、建造契約がない場合には 2017 年 7 月 1 日以降に起工又は同等段階にある船舶、2020 年 7 月 1 日以降に引渡しが行われる船舶に適用されます。

(次頁に続く)

(2) 自動運航船に対する規則の検討

船舶の自動化が進んでいる中で、前回の会合で自動運航船に関わる航行上の安全や海洋環境に関するIMOの諸規則の論点整理を開始すべき旨の提案があり、本会合において具体的な検討が開始されました。

審議の結果、自動運航船に関わるIMOの諸規制の論点整理を行う上で、暫定的な自動運航船の定義及び自動化の程度、検討手法、作業計画を含む作業指針が策定されました。本作業指針に従って、今後自動運航船に関わるIMOの諸規制の論点整理を実施することになりました。

なお、本件に関してご不明な点は、以下の部署にお問い合わせください。

一般財団法人 日本海事協会 (ClassNK)

本部 管理センター別館 国際部

住所: 東京都千代田区紀尾井町 3-3 (郵便番号 102-0094)

Tel.: 03-5226-2038

Fax: 03-5226-2734

E-mail: xad@classnk.or.jp

添付:

1. RESOLUTION MSC.436(99)
2. RESOLUTION MSC.437(99)
3. RESOLUTION MSC.438(99)
4. RESOLUTION MSC.439(99)
5. RESOLUTION MSC.440(99)
6. RESOLUTION MSC.441(99)
7. RESOLUTION MSC.442(99)
8. RESOLUTION MSC.445(99)
9. RESOLUTION MSC.446(99)
10. RESOLUTION MSC.447(99)
11. AMENDMENTS TO THE CODE FOR EXISTING SHIPS CARRYING LIQUEFIED GASES IN BULK (EGC CODE)
12. DRAFT MSC RESOLUTION ON AMENDMENTS TO THE INTERNATIONAL CODE ON THE ENHANCED PROGRAMME OF INSPECTIONS DURING SURVEYS OF BULK CARRIERS AND OIL TANKERS, 2011 (2011 ESP CODE)
13. MSC.1/Circ.1500/Rev.1
14. MSC.1/Circ.1587
15. MSC.1/Circ.1588
16. MSC.1/Circ.1590
17. MSC.1/Circ.1591
18. MSC.1/Circ.1594

ANNEX 1

**RESOLUTION MSC.436(99)
(adopted on 24 May 2018)**

**AMENDMENTS TO THE INTERNATIONAL CONVENTION FOR
THE SAFETY OF LIFE AT SEA, 1974, AS AMENDED**

THE MARITIME SAFETY COMMITTEE,

RECALLING Article 28(b) of the Convention on the International Maritime Organization concerning the functions of the Committee,

RECALLING ALSO article VIII(b) of the International Convention for the Safety of Life at Sea (SOLAS), 1974 ("the Convention"), concerning the amendment procedure applicable to the annex to the Convention, other than to the provisions of chapter I,

RECALLING FURTHER resolution MSC.421(98), by which it adopted, inter alia, amendments to regulations II-1/1 and II-1/8-1 of the Convention,

HAVING CONSIDERED, at its ninety-ninth session, amendments to the Convention, proposed and circulated in accordance with article VIII(b)(i) of the Convention,

1 ADOPTS, in accordance with article VIII(b)(iv) of the Convention, amendments to the Convention, the text of which is set out in the annex to the present resolution;

2 AGREES that the amendments to regulations II-1/1 and II-1/8-1 of the Convention, as adopted by resolution MSC.421(98), shall be superseded by the amendments to regulations II-1/1 and II-1/8-1 of the Convention, set out in the annex to the present resolution;

3 DETERMINES, in accordance with article VIII(b)(vi)(2)(bb) of the Convention, that said amendments shall be deemed to have been accepted on 1 July 2019, unless, prior to that date, more than one third of the Contracting Governments to the Convention or Contracting Governments, the combined merchant fleets of which constitute not less than 50% of the gross tonnage of the world's merchant fleet, have notified the Secretary-General of their objections to the amendments;

4 INVITES Contracting Governments to the Convention to note that, in accordance with article VIII(b)(vii)(2) of the Convention, the amendments shall enter into force on 1 January 2020 upon their acceptance in accordance with paragraph 2 above;

5 REQUESTS the Secretary-General, for the purposes of article VIII(b)(v) of the Convention, to transmit certified copies of the present resolution and the text of the amendments contained in the annex to all Contracting Governments to the Convention;

6 REQUESTS ALSO the Secretary-General to transmit copies of this resolution and its annex to Members of the Organization which are not Contracting Governments to the Convention.

ANNEX

**AMENDMENTS TO THE INTERNATIONAL CONVENTION FOR
THE SAFETY OF LIFE AT SEA, 1974, AS AMENDED**

**CHAPTER II-1
CONSTRUCTION – STRUCTURE, SUBDIVISION AND STABILITY, MACHINERY AND
ELECTRICAL INSTALLATIONS**

**PART A
GENERAL**

Regulation 1 – Application

1 The following new paragraphs 1.1.1 and 1.1.2 are inserted after the existing paragraph 1.1:

- "1.1.1 Unless expressly provided otherwise, parts B, B-1, B-2 and B-4 of this chapter shall only apply to ships:
- .1 for which the building contract is placed on or after 1 January 2020;
or
 - .2 in the absence of a building contract, the keel of which is laid or which are at a similar stage of construction on or after 1 July 2020;
or
 - .3 the delivery of which is on or after 1 January 2024.
- 1.1.2 Unless expressly provided otherwise, for ships not subject to the provisions of sub-paragraph 1.1.1 but constructed on or after 1 January 2009, the Administration shall:
- .1 ensure that the requirements for parts B, B-1, B-2 and B-4 which are applicable under chapter II-1 of the International Convention for the Safety of Life at Sea, 1974, as amended by resolutions MSC.216(82), MSC.269(85) and MSC.325(90) are complied with; and
 - .2 ensure that the requirements of regulations 8-1.3 and 19-1 are complied with."

2 The existing paragraph 1.3.4 is deleted.

3 The existing paragraph 2 is replaced with the following:

"2 Unless expressly provided otherwise, for ships constructed before 1 January 2009, the Administration shall:

- .1 ensure that the requirements which are applicable under chapter II-1 of the International Convention for the Safety of Life at Sea, 1974, as amended by resolutions MSC.1(XLV), MSC.6(48), MSC.11(55), MSC.12(56), MSC.13(57), MSC.19(58), MSC.26(60), MSC.27(61), Resolution 1 of the 1995 SOLAS Conference, MSC.47(66), MSC.57(67), MSC.65(68), MSC.69(69), MSC.99(73), MSC.134(76), MSC.151(78) and MSC.170(79) are complied with; and
- .2 ensure that the requirements of regulations 8-1.3 and 19-1 are complied with."

**PART B-1
STABILITY**

Regulation 8-1 – System capabilities and operational information after a flooding casualty on passenger ships

4 The existing text of regulation 8-1 is amended to read as follows:

"1 Application

Passenger ships having length, as defined in regulation II-1/2.5, of 120 m or more or having three or more main vertical zones shall comply with the provisions of this regulation.

2 Availability of essential systems in case of flooding damage*

A passenger ship shall be designed so that the systems specified in regulation II-2/21.4 remain operational when the ship is subject to flooding of any single watertight compartment.

3 Operational information after a flooding casualty

3.1 For the purpose of providing operational information to the master for safe return to port after a flooding casualty, passenger ships, as specified in paragraph 1, shall have:

- .1 an onboard stability computer; or
- .2 shore-based support,

based on the guidelines developed by the Organization.**

3.2 Passenger ships constructed before 1 January 2014 shall comply with the provisions in paragraph 3.1 not later than the first renewal survey after 1 January 2025.

* Refer to the *Interim Explanatory Notes for the assessment of passenger ship systems' capabilities after a fire or flooding casualty* (MSC.1/Circ.1369).

** Refer to the *Guidelines on operational information for Masters of passenger ships for safe return to port by own power or under tow* (MSC.1/Circ.1400) for ships constructed on or after 1 January 2014 but before 13 May 2016, or the *Revised Guidelines on operational information for masters of passenger ships for safe return to port* (MSC.1/Circ.1532/Rev.1) for ships constructed on or after 13 May 2016, or the *Guidelines on operational information for masters in case of flooding for passenger ships constructed before 1 January 2014* (MSC.1/Circ.1589)."

CHAPTER IV RADIOCOMMUNICATIONS

PART A GENERAL

Regulation 2 – Terms and definitions

5 In paragraph 1, the existing sub-paragraph .16 is amended and new sub-paragraph .17 is added as follows:

".16 *Global maritime distress and safety system (GMDSS) identities* means maritime mobile services identity, the ship's call sign, recognized mobile satellite service identities and serial number identity which may be transmitted by the ship's equipment and used to identify the ship.

.17 *Recognized mobile satellite service* means any service which operates through a satellite system and is recognized by the Organization, for use in the global maritime distress and safety system (GMDSS)."

PART C SHIP REQUIREMENTS

Regulation 7 – Radio equipment: General

6 In paragraph 1, the existing sub-paragraph .5 is amended to read as follows:

".5 a radio facility for reception of maritime safety information by a recognized mobile satellite service enhanced group calling system if the ship is engaged in voyages in sea area A1, or A2 or A3 but in which an international NAVTEX service is not provided. However, ships engaged exclusively in voyages in areas where an HF direct-printing telegraphy maritime safety information service is provided and fitted with equipment capable of receiving such service, may be exempt from this requirement.*

* Refer to the *Recommendation on promulgation of maritime safety information* adopted by the Organization by resolution A.705(17), as amended."

Regulation 8 – Radio equipment: Sea area A1

7 In paragraph 1, the existing sub-paragraph .5 is amended to read as follows:

".5 through a recognized mobile satellite service; this requirement may be fulfilled by:

.5.1 a ship earth station;* or

.5.2 the satellite EPIRB, required by regulation 7.1.6, either by installing the satellite EPIRB close to, or by remote activation from, the position from which the ship is normally navigated.

* This requirement can be met by recognized mobile satellite service ship earth stations capable of two-way communications, such as Fleet-77 (resolutions A.808(19) and MSC.130(75)) or Inmarsat-C (resolution A.807(19), as amended) ship earth stations. Unless otherwise specified, this footnote applies to all requirements for a recognized mobile satellite service ship earth station prescribed by this chapter."

Regulation 9 – Radio equipment: Sea areas A1 and A2

8 In paragraph 1, the existing sub-paragraph .3.3 is amended to read as follows:

".3.3 through a recognized mobile satellite service by a ship earth station."

9 In paragraph 3, the existing sub-paragraph .2 is amended to read as follows:

".2 a recognized mobile satellite service ship earth station."

Regulation 10 – Radio equipment: Sea areas A1, A2 and A3

10 In paragraph 1, the existing chapeau of sub-paragraph .1 is amended to read as follows:

".1 a recognized mobile satellite service ship earth station capable of:"

11 In paragraph 1, the existing sub-paragraph .4.3 is amended to read as follows:

".4.3 through a recognized mobile satellite service by an additional ship earth station."

12 In paragraph 2, the existing sub-paragraph .3.2 is amended to read as follows:

".3.2 through a recognized mobile satellite service by a ship earth station; and"

Regulation 12 – Watches

13 In paragraph 1, the existing sub-paragraph .4 is amended to read as follows:

".4 for satellite shore-to-ship distress alerts, if the ship, in accordance with the requirements of regulation 10.1.1, is fitted with a recognized mobile satellite service ship earth station."

Regulation 13 – Sources of energy

- 14 In paragraph 2, the word "Inmarsat" is deleted from the second sentence.

**APPENDIX
CERTIFICATES**

RECORD OF EQUIPMENT FOR PASSENGER SHIP SAFETY (FORM P)

- 15 In section 3, the existing description of item 1.4 is amended to read as follows:
"Recognized mobile satellite service ship earth station".

RECORD OF EQUIPMENT FOR CARGO SHIP SAFETY RADIO (FORM R)

- 16 In section 2, the existing description of item 1.4 is amended to read as follows:
"Recognized mobile satellite service ship earth station".

RECORD OF EQUIPMENT FOR CARGO SHIP SAFETY (FORM C)

- 17 In section 3, the existing description of item 1.4 is replaced by the following:
"Recognized mobile satellite service ship earth station".

ANNEX 2

**RESOLUTION MSC.437(99)
(adopted on 24 May 2018)**

**AMENDMENTS TO THE INTERNATIONAL CODE FOR
APPLICATION OF FIRE TEST PROCEDURES, 2010
(2010 FTP CODE)**

THE MARITIME SAFETY COMMITTEE,

RECALLING Article 28(b) of the Convention on the International Maritime Organization concerning the functions of the Committee,

NOTING resolution MSC.61(67), by which it adopted the International Code for Application of Fire Test Procedures, which has become mandatory under chapter II-2 of the International Convention for the Safety of Life at Sea (SOLAS), 1974 ("the Convention"),

NOTING ALSO resolution MSC.307(88), by which it adopted the International Code for Application of Fire Test Procedures, 2010 ("2010 FTP Code"),

NOTING FURTHER article VIII(b) and regulation II-2/3.23 of the Convention concerning the procedure for amending the 2010 FTP Code,

HAVING CONSIDERED, at its ninety-ninth session, amendments to the 2010 FTP Code, proposed and circulated in accordance with article VIII(b)(i) of the Convention,

1 ADOPTS in accordance with article VIII(b)(iv) of the Convention, amendments to the 2010 FTP Code, the text of which is set out in the annex to the present resolution;

2 DETERMINES, in accordance with article VIII(b)(vi)(2)(bb) of the Convention, that said amendments shall be deemed to have been accepted on 1 July 2019, unless, prior to that date, more than one third of the Contracting Governments to the Convention or Contracting Governments, the combined merchant fleets of which constitute not less than 50% of the gross tonnage of the world's merchant fleet, have notified the Secretary-General of their objections to the amendments;

3 INVITES Contracting Governments to the Convention to note that, in accordance with article VIII(b)(vii)(2) of the Convention, the amendments shall enter into force on 1 January 2020 upon their acceptance in accordance with paragraph 2 above;

4 REQUESTS the Secretary-General, for the purposes of article VIII(b)(v) of the Convention, to transmit certified copies of the present resolution and the text of the amendments contained in the annex to all Contracting Governments to the Convention;

5 REQUESTS ALSO the Secretary-General to transmit copies of this resolution and its annex to Members of the Organization which are not Contracting Governments to the Convention.

ANNEX

**AMENDMENTS TO THE INTERNATIONAL CODE FOR APPLICATION
OF FIRE TEST PROCEDURES, 2010
(2010 FTP CODE)**

ANNEX 3

FIRE PROTECTION MATERIALS AND REQUIRED APPROVAL TEST METHODS

1 The existing title of table 1 is amended to read as follows:

"Table 1 – Fire protection materials and required approval test methods for passenger ships and high-speed craft".

2 In table 1, the existing column "Applicable regulation" is amended as follows:

- .1 in rows "'A" class bulkhead", "'B" class bulkhead", "'C" class bulkhead", "'A" class deck", "'B" class deck", "'B" class lining" and "'B" class ceilings", the reference to "9.2.2.4" is added;
- .2 in row "'B" class continuous ceilings", the reference to "9.2.2.4.3" is added;
- .3 in row "Partial bulkheads", the reference to "5.3.1.2.1" is replaced with the reference to "5.3.1.3.1"; and
- .4 in row "Fire Door Control System", the reference to "9.4.1.1.4.15" is replaced with the reference to "9.4.1.1.5.15".

ANNEX 3

**RESOLUTION MSC.438(99)
(adopted on 24 May 2018)**

**AMENDMENTS TO THE INTERNATIONAL CODE OF
SAFETY FOR HIGH-SPEED CRAFT, 1994 (1994 HSC CODE)**

THE MARITIME SAFETY COMMITTEE,

RECALLING Article 28(b) of the Convention on the International Maritime Organization concerning the functions of the Committee,

NOTING resolution MSC.36(63), by which it adopted the International Code of Safety for High-Speed Craft ("the 1994 HSC Code"), which has become mandatory under chapter X of the International Convention for the Safety of Life at Sea (SOLAS), 1974 ("the Convention"),

NOTING ALSO article VIII(b) and regulation X/1.1 of the Convention concerning the procedure for amending the 1994 HSC Code,

HAVING CONSIDERED, at its ninety-ninth session, amendments to the 1994 HSC Code, proposed and circulated in accordance with article VIII(b)(i) of the Convention,

1 ADOPTS, in accordance with article VIII(b)(iv) of the Convention, amendments to the 1994 HSC Code, the text of which is set out in the annex to the present resolution;

2 DETERMINES, in accordance with article VIII(b)(vi)(2)(bb) of the Convention, that said amendments shall be deemed to have been accepted on 1 July 2019, unless, prior to that date, more than one third of the Contracting Governments to the Convention or Contracting Governments, the combined merchant fleets of which constitute not less than 50% of the gross tonnage of the world's merchant fleet, have notified their objections to the amendments;

3 INVITES Contracting Governments to the Convention to note that, in accordance with article VIII(b)(vii)(2) of the Convention, the amendments shall enter into force on 1 January 2020 upon their acceptance in accordance with paragraph 2 above;

4 REQUESTS the Secretary-General, for the purposes of article VIII(b)(v) of the Convention, to transmit certified copies of the present resolution and the text of the amendments contained in the annex to all Contracting Governments to the Convention;

5 REQUESTS ALSO the Secretary-General to transmit copies of this resolution and its annex to Members of the Organization which are not Contracting Governments to the Convention.

ANNEX

**AMENDMENTS TO THE INTERNATIONAL CODE OF SAFETY
FOR HIGH-SPEED CRAFT, 1994 (1994 HSC CODE)**

**CHAPTER 14
RADIOCOMMUNICATIONS**

14.2 Terms and definitions

1 In paragraph 14.2.1, the following new sub-paragraph .16 is added after the existing sub-paragraph .15:

".16 *Recognized mobile satellite service* means any service which operates through a satellite system and is recognized by the Organization, for use in the global maritime distress and safety system (GMDSS)."

14.6 Radio equipment: General

2 In paragraph 14.6.1, the existing sub-paragraph .5 is amended to read as follows:

".5 a radio facility for reception of maritime safety information by a recognized mobile satellite service enhanced group calling system if the craft is engaged in voyages in sea area A1, or A2 or A3 but in which an international NAVTEX service is not provided. However, craft engaged exclusively in voyages in areas where an HF direct-printing telegraphy maritime safety information service is provided and fitted with equipment capable of receiving such service, may be exempt from this requirement.*"

* Refer to the *Recommendation on promulgation of maritime safety information* adopted by the Organization by resolution A.705(17), as amended."

3 In paragraph 14.6.1, the existing sub-paragraph .6.1 is amended to read as follows:

".6.1 capable of transmitting a distress alert through the polar orbiting satellite service operating in the 406 MHz band;".

14.7 Radio equipment: Sea area A1

4 In paragraph 14.7.1, the existing sub-paragraph .5 is amended to read as follows:

".5 through a recognized mobile satellite service; this requirement may be fulfilled by:

.5.1 a ship earth station;* or

- .5.2 the satellite EPIRB, required by 14.6.1.6, either by installing the satellite EPIRB close to, or by remote activation from, the position from which the craft is normally navigated.

* This requirement can be met by recognized mobile satellite service ship earth stations capable of two-way communications, such as Fleet 77 (resolution A.808(19) and MSC.130(75)) or Inmarsat-C (resolution A.807(19), as amended) ship earth stations. Unless otherwise specified, this footnote applies to all requirements for a recognized mobile satellite service ship earth station prescribed by this chapter."

14.8 Radio equipment: Sea areas A1 and A2

5 In paragraph 14.8.1, the existing sub-paragraph .3.3 is amended to read as follows:

".3.3 through a recognized mobile satellite service by a ship earth station."

6 In paragraph 14.8.3, the existing sub-paragraph .2 is amended to read as follows:

".2 a recognized mobile satellite service ship earth station."

14.9 Radio equipment: Sea areas A1, A2 and A3

7 In paragraph 14.9.1, the chapeau of existing sub-paragraph .1 is amended to read as follows:

".1 a recognized mobile satellite service ship earth station capable of:"

8 In paragraph 14.9.1, the existing sub-paragraph .4.3 is amended to read as follows:

".4.3 through a recognized mobile satellite service by an additional ship earth station."

9 In paragraph 14.9.2, the existing sub-paragraph .3.2 is amended to read as follows:

".3.2 through a recognized mobile satellite service by a ship earth station; and"

14.11 Watches

10 In paragraph 14.11.1, the existing sub-paragraph .4 is amended to read as follows:

".4 for satellite shore-to-ship distress alerts, if the craft, in accordance with the requirements of 14.9.1.1, is fitted with a recognized mobile satellite service ship earth station."

14.12 Sources of energy

11 In paragraph 14.12.2, the word "Inmarsat" is deleted from the second sentence.

Annex

FORM OF SAFETY CERTIFICATE FOR HIGH-SPEED CRAFT

**RECORD OF EQUIPMENT FOR COMPLIANCE WITH THE INTERNATIONAL CODE OF
SAFETY FOR HIGH-SPEED CRAFT**

12 In section 3, the existing description of item 1.4 is amended to read as follows:

"Recognized mobile satellite service ship earth station".

ANNEX 4

**RESOLUTION MSC.439(99)
(adopted on 24 May 2018)**

**AMENDMENTS TO THE INTERNATIONAL CODE OF
SAFETY FOR HIGH-SPEED CRAFT, 2000 (2000 HSC CODE)**

THE MARITIME SAFETY COMMITTEE,

RECALLING Article 28(b) of the Convention on the International Maritime Organization concerning the functions of the Committee,

NOTING resolution MSC.97(73), by which it adopted the International Code of Safety for High-Speed Craft, 2000 ("the 2000 HSC Code"), which has become mandatory under chapter X of the International Convention for the Safety of Life at Sea (SOLAS), 1974 ("the Convention"),

NOTING ALSO article VIII(b) and regulation X/1.2 of the Convention concerning the procedure for amending the 2000 HSC Code,

HAVING CONSIDERED, at its ninety-ninth session, amendments to the 2000 HSC Code, proposed and circulated in accordance with article VIII(b)(i) of the Convention,

1 ADOPTS, in accordance with article VIII(b)(iv) of the Convention, amendments to the 2000 HSC Code, the text of which is set out in the annex to the present resolution;

2 DETERMINES, in accordance with article VIII(b)(vi)(2)(bb) of the Convention, that said amendments shall be deemed to have been accepted on 1 July 2019, unless, prior to that date, more than one third of the Contracting Governments to the Convention or Contracting Governments, the combined merchant fleets of which constitute not less than 50% of the gross tonnage of the world's merchant fleet, have notified the Secretary-General of their objections to the amendments;

3 INVITES Contracting Governments to the Convention to note that, in accordance with article VIII(b)(vii)(2) of the Convention, the amendments shall enter into force on 1 January 2020 upon their acceptance in accordance with paragraph 2 above;

4 REQUESTS the Secretary-General, for the purposes of article VIII(b)(v) of the Convention, to transmit certified copies of the present resolution and the text of the amendments contained in the annex to all Contracting Governments to the Convention;

5 REQUESTS ALSO the Secretary-General to transmit copies of this resolution and its annex to Members of the Organization which are not Contracting Governments to the Convention.

ANNEX

**AMENDMENTS TO THE INTERNATIONAL CODE OF SAFETY
FOR HIGH-SPEED CRAFT, 2000 (2000 HSC CODE)**

**CHAPTER 14
RADIOCOMMUNICATIONS**

14.2 Terms and definitions

1 In paragraph 14.2.1, the existing sub-paragraph .6 is amended to read as follows:

".6 *Global maritime distress and safety system (GMDSS) identities* means maritime mobile services identity, the craft's call sign, recognized mobile satellite service identities and serial number identity which may be transmitted by the craft's equipment and used to identify the craft."

2 In paragraph 14.2.1, the following new sub-paragraph .17 is added after existing sub-paragraph .16:

".17 *Recognized mobile satellite service* means any service which operates through a satellite system and is recognized by the Organization, for use in the global maritime distress and safety system (GMDSS)."

14.7 Radio equipment: General

3 In paragraph 14.7.1, the existing sub-paragraph .5 is amended to read as follows:

".5 a radio facility for reception of maritime safety information by a recognized mobile satellite service enhanced group calling system if the craft is engaged in voyages in sea area A1, or A2 or A3 but in which an international NAVTEX service is not provided. However, craft engaged exclusively in voyages in areas where an HF direct-printing telegraphy maritime safety information service is provided and fitted with equipment capable of receiving such service, may be exempt from this requirement.*

* Refer to the *Recommendation on promulgation of maritime safety information*, adopted by the Organization by resolution A.705(17), as amended."

4 In paragraph 14.7.1, the existing sub-paragraph .6.1 is amended to read as follows:

".6.1 capable of transmitting a distress alert through the polar orbiting satellite service operating in the 406 MHz band;".

14.8 Radio equipment: Sea area A1

5 In paragraph 14.8.1, the existing sub-paragraph .5 is amended to read as follows:

".5 through a recognized mobile satellite service; this requirement may be fulfilled by:

.5.1 a ship earth station;* or

- .5.2 the satellite EPIRB, required by 14.7.1.6, either by installing the satellite EPIRB close to, or by remote activation from, the position from which the craft is normally navigated.

* This requirement can be met by recognized mobile satellite service ship earth stations capable of two-way communications, such as Fleet-77 (resolution A.808(19) and MSC.130(75)) or Inmarsat-C (resolution A.807(19), as amended) ship earth stations. Unless otherwise specified, this footnote applies to all requirements for a recognized mobile satellite service ship earth station prescribed by this chapter."

14.9 Radio equipment: Sea areas A1 and A2

6 In paragraph 14.9.1, the existing sub-paragraph .3.3 is amended to read as follows:

".3.3 through a recognized mobile satellite service by a ship earth station."

7 In paragraph 14.9.3, the existing sub-paragraph .2 is amended to read as follows:

".2 a recognized mobile satellite service ship earth station."

14.10 Radio equipment: Sea areas A1, A2 and A3

8 In paragraph 14.10.1, the chapeau of existing sub-paragraph .1 is amended to read as follows:

".1 a recognized mobile satellite service ship earth station capable of:"

9 In paragraph 14.10.1, the existing sub-paragraph .4.3 is amended to read as follows:

".4.3 through a recognized mobile satellite service by an additional ship earth station."

10 In paragraph 14.10.2, the existing sub-paragraph 3.2 is amended to read as follows:

".3.2 through a recognized mobile satellite service by a ship earth station; and".

14.12 Watches

11 In paragraph 14.12.1, the existing sub-paragraph .4 is amended to read as follows:

".4 for satellite shore-to-ship distress alerts, if the craft, in accordance with the requirements of 14.10.1.1, is fitted with a recognized mobile satellite service ship earth station."

14.13 Sources of energy

12 In paragraph 14.13.2, the word "Inmarsat" is deleted from the second sentence.

Annex

**FORM OF HIGH-SPEED CRAFT SAFETY CERTIFICATE AND RECORD OF EQUIPMENT
RECORD OF EQUIPMENT FOR COMPLIANCE WITH THE INTERNATIONAL CODE OF
SAFETY FOR HIGH-SPEED CRAFT, 2000**

13 In section 4, the existing description of item 1.4 is amended to read as follows:

"Recognized mobile satellite service ship earth station".

ANNEX 5

**RESOLUTION MSC.440(99)
(adopted on 24 May 2018)**

**AMENDMENTS TO THE INTERNATIONAL CODE FOR THE CONSTRUCTION AND
EQUIPMENT OF SHIPS CARRYING DANGEROUS
CHEMICALS IN BULK (IBC CODE)**

THE MARITIME SAFETY COMMITTEE,

RECALLING Article 28(b) of the Convention on the International Maritime Organization concerning the functions of the Committee,

NOTING resolution MSC.4(48), by which it adopted the International Code for the Construction and Equipment of Ships Carrying Dangerous Chemicals in Bulk ("the IBC Code"), which has become mandatory under chapter VII of the International Convention for the Safety of Life at Sea (SOLAS), 1974 ("the Convention"),

NOTING ALSO article VIII(b) and regulation VII/8.1 of the Convention concerning the procedure for amending the IBC Code,

HAVING CONSIDERED, at its ninety-ninth session, amendments to the IBC Code, proposed and circulated in accordance with article VIII(b)(i) of the Convention,

1 ADOPTS, in accordance with article VIII(b)(iv) of the Convention, amendments to the IBC Code, the text of which is set out in the annex to the present resolution;

2 DETERMINES, in accordance with article VIII(b)(vi)(2)(bb) of the Convention, that said amendments shall be deemed to have been accepted on 1 July 2019, unless, prior to that date, more than one third of the Contracting Governments to the Convention or Contracting Governments, the combined merchant fleets of which constitute not less than 50% of the gross tonnage of the world's merchant fleet, have notified the Secretary-General of their objections to the amendments;

3 INVITES Contracting Governments to note that, in accordance with article VIII(b)(vii)(2) of the Convention, the amendments shall enter into force on 1 January 2020 upon its acceptance in accordance with paragraph 2 above;

4 REQUESTS the Secretary-General, for the purposes of article VIII(b)(v) of the Convention, to transmit certified copies of the present resolution and the text of the amendments contained in the annex to all Contracting Governments to the Convention;

5 REQUESTS ALSO the Secretary-General to transmit copies of this resolution and its annex to Members of the Organization which are not Contracting Governments to the Convention.

ANNEX

**AMENDMENTS TO THE INTERNATIONAL CODE FOR THE CONSTRUCTION AND
EQUIPMENT OF SHIPS CARRYING DANGEROUS
CHEMICALS IN BULK (IBC CODE)**

In the appendix, the existing paragraph 6 of the model form of International Certificate of Fitness for the Carriage of Dangerous Chemicals in Bulk is replaced with the following:

- "6 That the loading and stability information booklet required by paragraph 2.2.5 of the Code has been supplied to the ship in an approved form.
- 7 That the ship must be loaded:
- .1* only in accordance with loading conditions verified compliant with intact and damage stability requirements using the approved stability instrument fitted in accordance with paragraph 2.2.6 of the Code;
 - .2* where a waiver permitted by paragraph 2.2.7 of the Code is granted and the approved stability instrument required by paragraph 2.2.6 of the Code is not fitted, loading shall be made in accordance with one or more of the following approved methods:
 - (i)* in accordance with the loading conditions provided in the approved loading and stability information booklet referred to in 6 above; or
 - (ii)* in accordance with loading conditions verified remotely using an approved means.....; or
 - (iii)* in accordance with a loading condition which lies within an approved range of conditions defined in the approved loading and stability information booklet referred to in 6 above; or
 - (iv)* in accordance with a loading condition verified using approved critical KG/GM data defined in the approved loading and stability information booklet referred to in 6 above; and
 - .3* in accordance with the loading limitations appended to this Certificate.

Where it is required to load the ship other than in accordance with the above instruction, then the necessary calculations to justify the proposed loading conditions shall be communicated to the certifying Administration who may authorize in writing the adoption of the proposed loading condition.**

* Delete as appropriate.

** Instead of being incorporated in the Certificate, this text may be appended to the Certificate, if duly signed and stamped."

ANNEX 6

RESOLUTION MSC.441(99)
(adopted on 24 May 2018)

**AMENDMENTS TO THE INTERNATIONAL CODE FOR THE CONSTRUCTION AND
EQUIPMENT OF SHIPS CARRYING LIQUEFIED GASES IN BULK (IGC CODE)**

THE MARITIME SAFETY COMMITTEE,

RECALLING Article 28(b) of the Convention on the International Maritime Organization concerning the functions of the Committee,

NOTING resolution MSC.5(48), by which it adopted the International Code for the Construction and Equipment of Ships Carrying Liquefied Gases in Bulk ("the IGC Code"), which has become mandatory under chapter VII of the International Convention for the Safety of Life at Sea (SOLAS), 1974 ("the Convention"),

NOTING ALSO article VIII(b) and regulation VII/11.1 of the Convention concerning the procedure for amending the IGC Code,

HAVING CONSIDERED, at its ninety-ninth session, amendments to the IGC Code, proposed and circulated in accordance with article VIII(b)(i) of the Convention,

1 ADOPTS, in accordance with article VIII(b)(iv) of the Convention, amendments to the IGC Code, the text of which is set out in the annex to the present resolution;

2 DETERMINES, in accordance with article VIII(b)(vi)(2)(bb) of the Convention, that said amendments shall be deemed to have been accepted on 1 July 2019, unless, prior to that date, more than one third of the Contracting Governments to the Convention or Contracting Governments, the combined merchant fleets of which constitute not less than 50% of the gross tonnage of the world's merchant fleet, have notified the Secretary-General of their objections to the amendments;

3 INVITES Contracting Governments to note that, in accordance with article VIII(b)(vii)(2) of the Convention, the amendments shall enter into force on 1 January 2020 upon its acceptance in accordance with paragraph 2 above;

4 REQUESTS the Secretary-General, for the purpose of article VIII(b)(v) of the Convention, to transmit certified copies of the present resolution and the text of the amendments contained in the annex to all Contracting Governments to the Convention;

5 REQUESTS ALSO the Secretary-General to transmit copies of this resolution and its annex to Members of the Organization, which are not Contracting Governments to the Convention.

ANNEX

AMENDMENTS TO THE INTERNATIONAL CODE FOR THE CONSTRUCTION AND EQUIPMENT OF SHIPS CARRYING LIQUEFIED GASES IN BULK (IGC CODE)

In appendix 2, the existing paragraph 6 of the model form of International Certificate of Fitness for the Carriage of Liquefied Gases in Bulk is replaced with the following:

- "6 That the loading and stability information booklet required by paragraph 2.2.5 of the Code has been supplied to the ship in an approved form.
- 7 That the ship shall be loaded:
- .1* only in accordance with loading conditions verified compliant with intact and damage stability requirements using the approved stability instrument fitted in accordance with paragraph 2.2.6 of the Code;
 - .2* where a dispensation permitted by paragraph 2.2.7 of the Code is granted and the approved stability instrument required by paragraph 2.2.6 of the Code is not fitted, loading shall be made in accordance with one or more of the following approved methods:
 - .i* in accordance with the loading conditions provided in the approved loading and stability information booklet referred to in 6 above; or
 - .ii* in accordance with loading conditions verified remotely using an approved means.....; or
 - .iii* in accordance with a loading condition which lies within an approved range of conditions defined in the approved loading and stability information booklet referred to in 6 above; or
 - .iv* in accordance with a loading condition verified using approved critical KG/GM data defined in the approved loading and stability information booklet referred to in 6 above; and
 - .3* in accordance with the loading limitations appended to this Certificate.

Where it is required to load the ship other than in accordance with the above instruction, then the necessary calculations to justify the proposed loading conditions shall be communicated to the certifying Administration who may authorize in writing the adoption of the proposed loading condition.**

* Delete as appropriate.

** Instead of being incorporated in the Certificate, this text may be appended to the Certificate, if duly signed and stamped."

ANNEX 7

**RESOLUTION MSC.442(99)
(adopted on 24 May 2018)**

**AMENDMENTS TO THE INTERNATIONAL
MARITIME DANGEROUS GOODS (IMDG) CODE**

THE MARITIME SAFETY COMMITTEE,

RECALLING Article 28(b) of the Convention on the International Maritime Organization concerning the functions of the Committee,

NOTING resolution MSC.122(75), by which it adopted the International Maritime Dangerous Goods Code (hereinafter referred to as "the IMDG Code"), which has become mandatory under chapter VII of the International Convention for the Safety of Life at Sea (SOLAS), 1974, as amended (hereinafter referred to as "the Convention"),

NOTING ALSO article VIII(b) and regulation VII/1.1 of the Convention concerning amendment procedure for amending the IMDG Code,

HAVING CONSIDERED, at its ninety-ninth session, amendments to the IMDG Code, proposed and circulated in accordance with article VIII(b)(i) of the Convention,

1 ADOPTS, in accordance with article VIII(b)(iv) of the Convention, amendments to the IMDG Code, the text of which is set out in the annexes to the present resolution;

2 DETERMINES, in accordance with article VIII(b)(vi)(2)(bb) of the Convention, that said amendments shall be deemed to have been accepted on 1 July 2019, unless prior to that date, more than one third of the Contracting Governments to the Convention or Contracting Governments, the combined merchant fleets of which constitute not less than 50% of the gross tonnage of the world's merchant fleet, have notified their objections to the amendments;

3 INVITES Contracting Governments to the Convention to note that, in accordance with article VIII(b)(vii)(2) of the Convention, the amendments shall enter into force on 1 January 2020 upon their acceptance in accordance with paragraph 2 above;

4 AGREES that Contracting Governments to the Convention may apply the aforementioned amendments in whole or in part on a voluntary basis from 1 January 2019;

5 REQUESTS the Secretary-General, for the purposes of article VIII(b)(v) of the Convention, to transmit certified copies of the present resolution and the text of the amendments contained in the annex to all Contracting Governments to the Convention;

6 REQUESTS ALSO the Secretary-General to transmit copies of this resolution and its annex to Members of the Organization which are not Contracting Governments to the Convention.

ANNEX

AMENDMENTS TO THE INTERNATIONAL MARITIME DANGEROUS GOODS (IMDG) CODE (AMENDMENT 39-18)

Table of Contents

Insert a new line for "2.0.6 Classification of articles as articles containing dangerous goods N.O.S."

Amend the contents for chapter 2.8 to read as follows:

- "2.8.1 Definition, general provisions and properties
- 2.8.2 General classification provisions
- 2.8.3 Packing group assignment for substances and mixtures
- 2.8.4 Alternative packing group assignment methods for mixtures: stepwise approach
- 2.8.5 Substances not accepted for transport"

Amend the subtitle of 4.2.6 to read "Additional provisions for the use of road tank vehicles and road gas elements vehicles".

Amend the title of chapter 5.3 to read "Placarding and marking of cargo transport units and bulk containers".

Amend the subtitle of chapter 5.3.2 to read "Marking".

In the title of chapter 6.1, delete "(other than for class 6.2 substances)".

Amend the title of chapter 6.8 to read "Provisions for road tank vehicles and road gas elements vehicles"

PART 1 GENERAL PROVISIONS, DEFINITIONS AND TRAINING

Chapter 1.1 General provisions

1.1.2 Conventions

1.1.2.2 International Convention for the Prevention of Pollution from Ships (MARPOL)

Annex III

Regulations for the prevention of pollution by harmful substances carried by sea in packaged form

Under the existing heading, a new chapter title "**Chapter 1 – General**" is added before the existing Regulation 1.

A new Regulation 1 is added with the corresponding footnotes as follows:

"Regulation 1

Definitions

For the purposes of this Annex:

1 *Harmful substances* are those substances which are identified as marine pollutants in the International Maritime Dangerous Goods Code (IMDG Code)* or which meet the criteria in the appendix of this Annex.

2 *Packaged form* is defined as the forms of containment specified for harmful substances in the IMDG Code.

3 *Audit* means a systematic, independent and documented process for obtaining audit evidence and evaluating it objectively to determine the extent to which audit criteria are fulfilled.

4 *Audit Scheme* means the IMO Member State Audit Scheme established by the Organization and taking into account the guidelines developed by the Organization.†

5 *Code for Implementation* means the IMO Instruments Implementation Code (III Code) adopted by the Organization by resolution A.1070(28).

6 *Audit Standard* means the Code for Implementation.

* Refer to the IMDG Code (resolution MSC.122(75), as amended.)

† Refer to the Framework and Procedures for the IMO Member State Audit Scheme (resolution A.1067 (28))."

The subsequent regulations are renumbered in this subsection accordingly.

In the renumbered Regulation 2, "Application", existing paragraph 1 with sub-paragraphs 1.1 and 1.2 are deleted. The existing paragraphs 2, 3, 4 and 5 are renumbered accordingly.

The existing Regulations 2 to 8 are renumbered as Regulations 3 to 9.

Before the appendix to Annex III (Criteria for the identification of harmful substances in packaged form) a new chapter 2 is added as follows with the corresponding footnote:

"Chapter 2 – Verification of compliance with the provisions of this Annex

Regulation 10

Application

Parties shall use the provisions of the Code for Implementation in the execution of their obligations and responsibilities contained in this Annex.

Regulation 11

Verification of compliance

1 Every Party shall be subject to periodic audits by the Organization in accordance with the audit standard to verify compliance with and implementation of this Annex.

2 The Secretary-General of the Organization shall have responsibility for administering the Audit Scheme, based on the guidelines developed by the Organization.

3 Every Party shall have responsibility for facilitating the conduct of the audit and implementation of a programme of actions to address the findings, based on the guidelines developed by the Organization.*

4 Audit of all Parties shall be:

.1 based on an overall schedule developed by the Secretary-General of the Organization, taking into account the guidelines developed by the Organization; and

.2 conducted at periodic intervals, taking into account the guidelines developed by the Organization.

* Refer to the Framework and Procedures for the IMO Member State Audit Scheme (resolution A.1067 (28)). "

Appendix to Annex III

Criteria for the identification of harmful substances in packaged form

The chapeau of the appendix is replaced as follows with the corresponding footnotes:

"For the purpose of this Annex, substances, other than radioactive materials,* identified by any one of the following criteria are harmful substances:†

* Refer to class 7, as defined in chapter 2.7 of the IMDG Code.

† The criteria are based on those developed by the United Nations Globally Harmonized System of Classification and Labelling of Chemicals (GHS), as amended. For definitions of acronyms or terms used in this appendix, refer to the relevant paragraphs of the IMDG Code."

Chapter 1.2

Definitions, units of measurement and abbreviations

1.2.1 Definitions

Amend the following definitions as indicated below:

Animal material: replace "or animal foodstuffs" with "foodstuffs or feedstuffs derived from animals".

GHS: replace "sixth" with "seventh" and replace "ST/SG/AC.10/30/Rev.6" with "ST/SG/AC.10/30/Rev.7".

Liquids: in the footnote, replace "ECE/TRANS/225 (Sales No. E.14.VIII.1)" with "ECE/TRANS/257 (Sales No. E.16.VIII.1)".

Manual of Tests and Criteria: after "ST/SG/AC.10/11/Rev.6", insert "and Amend.1".

Add the following new definition:

"*IMO type 9 tank* means a road gas elements vehicle for the transport of compressed gases of class 2 with elements linked to each other by a manifold, permanently attached to a chassis, which is fitted with items of service equipment and structural equipment necessary for the transport of gases. Elements are cylinders, tubes and bundles of cylinders, intended for the transport of gases as defined in 2.2.1.1."

1.2.3 List of abbreviations

In the definition of EmS, add the word "Revised" before the word "Emergency".

Chapter 1.3 Training

1.3.1 Training of shore-side personnel

1.3.1.5 Recommended training needs for shore-side personnel involved in the transport of dangerous goods under the IMDG Code

In the table, in function 3 "Mark, label or placard dangerous goods", in the column for "Specific training requirements", in the first indent, replace "risk" with "hazard".

1.3.1.6 Indicative table describing sections of the IMDG Code or other relevant instruments that may be appropriate to be considered in any training for the transport of dangerous goods

In the table, replace column "Guidelines for packing of cargo transport units" with "CTU Code"

1.3.1.7 Related Codes and publications which may be appropriate for function-specific training

1.3.1.7.2 Add the word "Revised" before the word "Emergency" and delete ", as amended" at the end.

Chapter 1.4 Security provisions

1.4.3 Provisions for high consequence dangerous goods

1.4.3.1.5 Replace "subsidiary risks" with "subsidiary hazards".

1.4.3.2 Specific security provisions for high consequence dangerous goods

1.4.3.2.1 At the end, insert the following note:

Note: In addition to the security provisions of this Code, competent authorities may implement further security provisions for reasons other than safety of dangerous goods during transport. In order to not impede international and multimodal transport by different explosives security marks, it is recommended that such marks be

formatted consistent with an internationally harmonized standard (e.g. European Union Commission Directive 2008/43/EC)."

Chapter 1.5 General provisions concerning radioactive material

1.5.5 Radioactive material possessing other dangerous properties

1.5.5.1 Replace "subsidiary risk" with "subsidiary hazard".

PART 2 CLASSIFICATION

Chapter 2.0 Introduction

2.0.0 Responsibilities

2.0.0.2 In the second indent, replace "subsidiary risk(s)" with "subsidiary hazard(s)".

2.0.1 Classes, divisions, packing groups

2.0.1.5 At the end of the last sentence, replace "subsidiary risk(s)" with "subsidiary hazard(s)".

2.0.1.6 At the end of the sentence, replace "subsidiary risk(s)" with "subsidiary hazard(s)".

2.0.2 UN numbers and proper shipping names

2.0.2.2 In the second paragraph, replace "subsidiary risk(s)" with "subsidiary hazard(s)".

2.0.2.5.3 Replace "subsidiary risk(s)" with "subsidiary hazard(s)".

2.0.2.10 Replace "subsidiary risk(s)" with "subsidiary hazard(s)".

2.0.3 Classification of substances, mixtures and solutions with multiple hazards (precedence of hazard characteristics)

2.0.3.1 At the end of the first sentence, add "or to assign the appropriate entry for articles containing dangerous goods N.O.S (UN 3537 to 3548, see 2.0.6)".

2.0.4 Transport of samples

2.0.4 Add a new provision 2.0.4.3 as follows:

"2.0.4.3 Samples of energetic materials for testing purposes

2.0.4.3.1 Samples of organic substances carrying functional groups listed in tables A6.1 and/or A6.3 in appendix 6 (Screening Procedures) of the Manual of Tests and Criteria may be transported under UN 3224 (self-reactive solid type C) or UN 3223 (self-reactive liquid type C), as applicable, of class 4.1 provided that:

- .1 the samples do not contain any:
 - known explosives;
 - substances showing explosive effects in testing;
 - compounds designed with the view of producing a practical explosive or pyrotechnic effect; or
 - components consisting of synthetic precursors of intentional explosives;
- .2 for mixtures, complexes or salts of inorganic oxidizing substances of class 5.1 with organic material(s), the concentration of the inorganic oxidizing substance is:
 - less than 15%, by mass, if assigned to packing group I (high hazard) or II (medium hazard); or
 - less than 30%, by mass, if assigned to packing group III (low hazard);
- .3 available data do not allow a more precise classification;
- .4 the sample is not packed together with other goods; and
- .5 the sample is packed in accordance with packing instruction P520 and special packing provisions PP94 or PP95 of 4.1.4.1, as applicable."

2.0.5 Transport of wastes

Add a new provision 2.0.6 as follows:

"2.0.6 Classification of articles as articles containing dangerous goods N.O.S.

Note: For articles which do not have an existing proper shipping name and which contain only dangerous goods within the permitted limited quantity amounts specified in column 7a of the Dangerous Goods List, see UN 3363 and special provision 301 of chapter 3.3.

2.0.6.1 Articles containing dangerous goods may be classified as otherwise provided by this Code under the proper shipping name for the dangerous goods they contain or in accordance with this section. For the purposes of this section "article" means machinery, apparatus or other devices containing one or more dangerous goods (or residues thereof) that are an integral element of the article, necessary for its functioning, and that cannot be removed for the purpose of transport. An inner packaging shall not be an article.

2.0.6.2 Such articles may in addition contain batteries. Lithium batteries that are integral to the article shall be of a type proven to meet the testing requirements of the Manual of Tests and Criteria, part III, subsection 38.3, except when pre-production prototype batteries or batteries of a small production run, consisting of not more than 100 batteries, are installed in the

article. Where a lithium battery installed in an article is damaged or defective, the battery shall be removed.

- 2.0.6.3 This section does not apply to articles for which a more specific proper shipping name already exists in the Dangerous Goods List of chapter 3.2.
- 2.0.6.4 This section does not apply to dangerous goods of class 1, class 6.2, class 7 or radioactive material contained in articles.
- 2.0.6.5 Articles containing dangerous goods shall be assigned to the appropriate class determined by the hazards present using, where applicable, the Precedence of Hazards table in 2.0.3.6 for each of the dangerous goods contained in the article. If dangerous goods classified as class 9 are contained within the article, all other dangerous goods present in the article shall be considered to present a higher hazard.
- 2.0.6.6 Subsidiary hazards shall be representative of the primary hazard posed by the other dangerous goods contained within the article. When only one dangerous good is present in the article, the subsidiary hazard(s), if any, shall be the subsidiary hazard(s) identified in column 4 of the Dangerous Goods List. If the article contains more than one dangerous good and these could react dangerously with one another during transport, each of the dangerous goods shall be enclosed separately (see 4.1.1.6)."

Chapter 2.1

Class 1 – Explosives

2.1.1 Definitions and general provisions

2.1.1.1.3 After "producing a practical", delete the comma.

2.1.1.4 Hazard divisions

In the note under division 1.6, replace "risk" with "hazard".

2.1.2 Compatibility groups and classification codes

2.1.2.2 Compatibility groups and classification codes

In the first column of the table, in the row for compatibility group L, replace "risk" with "hazard".

2.1.3 Classification procedure

2.1.3.4 Exclusion from class 1

2.1.3.4.2.5 In note 2, at the end of the sentence, replace "risk" with "hazard".

2.1.3.5 Assignment of fireworks to hazard divisions

2.1.3.5.1.1 Replace the words "giving a positive result when tested in one of the HSL Flash composition tests in appendix 7 of the Manual of Tests and Criteria" with "containing flash composition (see note 2 of 2.1.3.5.5)".

2.1.3.5.5 Amend note 2 to read as follows:

Note 2: "Flash composition" in this table refers to pyrotechnic substances in powder form or as pyrotechnic units as presented in the fireworks that are used in waterfalls, or to produce an aural effect or used as a bursting charge, or propellant charge unless:

- (a) the time taken for the pressure rise in the HSL Flash Composition Test in appendix 7 of the Manual of Tests and Criteria is demonstrated to be more than 6 ms for 0.5 g of pyrotechnic substance; or
- (b) the pyrotechnic substance gives a negative "-" result in the US Flash Composition Test in Appendix 7 of the Manual of Tests and Criteria."

In the table, amend the entry for "Waterfall" as follows: for classification 1.1G, amend the entry under "Specification" to read "Containing flash composition regardless of the results of Test Series 6 (see 2.1.3.5.1.1)". For classification 1.3G, amend the entry under "Specification" to read "Not containing flash composition".

Chapter 2.2 **Class 2 – Gases**

2.2.2.3 Class 2.3 Toxic gases

In the note, replace "risk" with "hazard".

2.2.3 Mixtures of gases

2.2.3.3 In the first sentence, replace "risk" with "hazard".

Chapter 2.3 **Class 3 – Flammable liquids**

2.3.2 Assignment of packing group

2.3.2.1 Replace "risk" with "hazard".

2.3.2.1.1 Replace "risk" with "hazard".

2.3.2.1.2 Replace "risk(s)" with "hazard(s)" twice.

2.3.2.2 In sub-paragraph .4, replace "30 litre" with "450 litre".

2.3.2.5 Replace provision 2.3.2.5 to read as follows:

"2.3.2.5 Viscous liquids which:

- have a flashpoint of 23°C or above and less than or equal to 60°C;
- are not toxic or corrosive;
- are not environmentally hazardous or are environmentally hazardous transported in single or combination packagings containing a net quantity per single or inner packaging of 5 litres or less, provided the packagings meet the general provisions of 4.1.1.1, 4.1.1.2 and 4.1.1.4 to 4.1.1.8;

- contain not more than 20% nitrocellulose provided the nitrocellulose contains not more than 12.6% nitrogen by dry mass; and
- are packed in receptacles of not more than 450 litre capacity,

are not subject to the provisions for the marking, labelling and testing of packages in chapters 4.1, 5.2 and 6.1, if:

- .1 in the solvent separation test (see part III, 32.5.1 of the Manual of Tests and Criteria) the height of the separated layer of solvent is less than 3% of the total height; and
- .2 the flowtime in the viscosity test (see part III, 32.4.3 of the Manual of Tests and Criteria) with a jet diameter of 6 mm is equal to or greater than:
 - .1 60 s; or
 - .2 40 s if the viscous liquid contains not more than 60% of class 3 substances.

The following statement shall be included in the transport document: "Transport in accordance with 2.3.2.5 of the IMDG Code" (see 5.4.1.5.10)."

Chapter 2.4

Class 4 – Flammable solids; substances liable to spontaneous combustion; substances which, in contact with water, emit flammable gases

2.4.0 Introductory note

In the introductory note, replace "additional subsidiary risk" with "additional subsidiary hazards".

2.4.2.3.2 Classification of self-reactive substances

2.4.2.3.2.2 In the second sentence, replace "subsidiary risks" with "subsidiary hazards".

2.4.2.3.2.3 At the end of the first paragraph, add a new sentence to read as follows:

"The formulations listed in packing instruction IBC520 of 4.1.4.2 and in portable tank instruction T23 of 4.2.5.2.6 may also be transported packed in accordance with packing method OP8 of packing instruction P520 of 4.1.4.1, with the same control and emergency temperatures, if applicable.",

and in the table, insert a new entry to read as follows:

3227	PHOSPHOROTHIOIC ACID, O-[(CYANOPHENYL METHYLENE) AZANYL] O,O-DIETHYL ESTER	82-91 (Z isomer)	OP8		(10)
------	--	------------------	-----	--	------

Remarks

In remark (2) after the table, replace "risk" with "hazard".

After remark (9), add a new remark (10) to read as follows:

"(10) This entry applies to the technical mixture in n-butanol within the specified concentration limits of the (Z) isomer."

2.4.2.3.3 Principles for classification of self-reactive substances

2.4.2.3.3.2 In sub-paragraphs .2 and .3, replace "risk" with "hazard".

2.4.2.5 Class 4.1 – Polymerizing substances and mixtures (stabilized)

2.4.2.5.2 Add the following new note at the end:

Note: Substances meeting the criteria of a polymerizing substance and also for inclusion in classes 1 to 8 are subject to the requirements of special provision 386 of chapter 3.3."

Chapter 2.5

Class 5 – Oxidizing substances and organic peroxides

2.5.2 Class 5.1 – Oxidizing substances

Note Renumber the existing note as note 1, and add a new note 2 as follows:

Note 2: By exception, solid ammonium nitrate based fertilizers shall be classified in accordance with the procedure as set out in the Manual of Tests and Criteria, part III, section 39."

2.5.3 Class 5.2 – Organic peroxides

2.5.3.2 Classification of organic peroxides

2.5.3.2.3 In the second sentence, replace "risks" with "hazards".

2.5.3.2.4 At the end of the note, add a new sentence to read as follows:

"The formulations listed in packing instruction IBC520 of 4.1.4.2 and in portable tank instruction T23 of 4.2.5.2.6 may also be transported packed in accordance with packing method OP8 of packing instruction P520 of 4.1.4.1, with the same control and emergency temperatures, if applicable."

In the table header, last column, replace "risks" with "hazards". In the table, insert the following new entries:

3109	1-PHENYLETHYL HYDROPEROXIDE	≤ 38		≥ 62			OP8			
3116	DI-(4-tert- BUTYLCYCLOHEXYL) PEROXYDICARBONATE	≤ 42 (as a paste)					OP7	35	40	
3119	DIISOBUTYRYL PEROXIDE	≤ 42 (as a stable dispersion in water)					OP8	-20	-10	

After the table, in remarks (3), (13), (18) and (27), replace "risk" with "hazard".

2.5.3.3 Principles for classification of organic peroxides

2.5.3.3.2.2 In the first sentence, replace "risk" with "hazard".

2.5.3.3.2.3 Replace "risk" with "hazard".

Chapter 2.6 Class 6 – Toxic and infectious substances

2.6.2 Class 6.1 – Toxic substances

2.6.2.2 Assignment of packing groups to toxic substances

2.6.2.2.1 Replace "risk" with "hazard" three times.

2.6.2.2.4.1 In the note, at the end of the last sentence, replace the wording "(see 2.8.2.3)" with the words "(see 2.8.2.4)".

2.6.2.4 Classification of pesticides

2.6.2.4.1 In the second sentence, replace "risks" with "hazards".

2.6.2.4.3 Replace "risks" with "hazards".

2.6.3 Class 6.2 – Infectious substances

2.6.3.1 Definitions

2.6.3.1.4 In the definition of "Patient specimens", after "*Patient specimens* are" replace "human or animal materials," with "those".

2.6.3.6 Infected animals

2.6.3.6.2 Delete paragraph 2.6.3.6.2.

Chapter 2.8
Class 8 – Corrosive substances

Replace entire chapter 2.8 with the following:

"Chapter 2.8

Class 8 – Corrosive substances

2.8.1 Definition, general provisions and properties

2.8.1.1 Definition

2.8.1.1.1 *Corrosive substances* are substances which, by chemical action, will cause irreversible damage to the skin, or, in the case of leakage, will materially damage, or even destroy, other goods or the means of transport.

2.8.1.1.2 For substances and mixtures that are corrosive to skin, general classification provisions are provided in section 2.8.2. Skin corrosion refers to the production of irreversible damage to the skin, namely, visible necrosis through the epidermis and into the dermis occurring after exposure to a substance or mixture.

2.8.1.1.3 Liquids and solids which may become liquid during transport, which are judged not to be skin corrosive shall still be considered for their potential to cause corrosion to certain metal surfaces in accordance with the criteria in 2.8.3.3.3.2.

2.8.1.2 Properties

2.8.1.2.1 In cases where particularly severe personal damage is to be expected, a note to that effect is made in the Dangerous Goods List in chapter 3.2 in the wording "causes (severe) burns to skin, eyes and mucous membranes".

2.8.1.2.2 Many substances are sufficiently volatile to evolve vapour irritating to the nose and eyes. If so, this fact is mentioned in the Dangerous Goods List in chapter 3.2 in the wording "vapour irritates mucous membranes".

2.8.1.2.3 A few substances may produce toxic gases when decomposed by very high temperatures. In these cases the statement "when involved in a fire, evolves toxic gases" appears in the Dangerous Goods List in chapter 3.2.

2.8.1.2.4 In addition to direct destructive action in contact with skin or mucous membranes, some substances in this class are toxic or harmful. Poisoning may result if they are swallowed, or if their vapour is inhaled; some of them even may penetrate the skin. Where appropriate, a statement is made to that effect in the Dangerous Goods List in chapter 3.2.

2.8.1.2.5 All substances in this class have a more or less destructive effect on materials such as metals and textiles.

2.8.1.2.5.1 In the Dangerous Goods List, the term "corrosive to most metals" means that any metal likely to be present in a ship, or in its cargo, may be attacked by the substance or its vapour.

2.8.1.2.5.2 The term "corrosive to aluminium, zinc, and tin" implies that iron or steel is not damaged in contact with the substance.

2.8.1.2.5.3 A few substances in this class can corrode glass, earthenware and other siliceous materials. Where appropriate, this is stated in the Dangerous Goods List in chapter 3.2.

2.8.1.2.6 Many substances in this class only become corrosive after having reacted with water, or with moisture in the air. This fact is indicated in the Dangerous Goods List in chapter 3.2 by the words "in the presence of moisture...". The reaction of water with many substances is accompanied by the liberation of irritating and corrosive gases. Such gases usually become visible as fumes in the air.

2.8.1.2.7A few substances in this class generate heat in reaction with water or organic materials, including wood, paper, fibres, some cushioning materials and certain fats and oils. Where appropriate, this is indicated in the Dangerous Goods List in chapter 3.2.

2.8.2 General classification provisions

2.8.2.1 Substances and mixtures of class 8 are divided among the three packing groups according to their degree of danger in transport:

- .1 packing group I: very dangerous substances and mixtures;
- .2 packing group II: substances and mixtures presenting medium danger; and
- .3 packing group III: substances and mixtures that present minor danger.

2.8.2.2 Allocation of substances listed in the Dangerous Goods List in chapter 3.2 to the packing groups in class 8 has been made on the basis of experience taking into account such additional factors as inhalation risk (see 2.8.2.4) and reactivity with water (including the formation of dangerous decomposition products).

2.8.2.3 New substances and mixtures can be assigned to packing groups on the basis of the length of time of contact necessary to produce irreversible damage of intact skin tissue in accordance with the criteria in 2.8.3. Alternatively, for mixtures, the criteria in 2.8.4 can be used.

2.8.2.4 A substance or mixture meeting the criteria of class 8 having an inhalation toxicity of dusts and mists (LC₅₀) in the range of packing group I, but toxicity through oral ingestion or dermal contact only in the range of packing group III or less, shall be allocated to class 8 (see note under 2.6.2.2.4.1).

2.8.3 Packing group assignment for substances and mixtures

2.8.3.1 Existing human and animal data including information from single or repeated exposure shall be the first line of evaluation, as they give information directly relevant to effects on the skin.

2.8.3.2 In assigning the packing group in accordance with 2.8.2.3, account shall be taken of human experience in instances of accidental exposure. In the absence of human experience the grouping shall be based on data obtained from experiments in accordance with OECD Test Guideline 404¹ or 435.² A substance or mixture which is

¹ OECD Guideline for the testing of chemicals No. 404, Acute Dermal Irritation/Corrosion 2015.

² OECD Guideline for the testing of chemicals No. 435, *In Vitro* Membrane Barrier Test Method for Skin Corrosion 2015.

determined not to be corrosive in accordance with OECD Test Guideline 430³ or 431⁴ may be considered not to be corrosive to skin for the purposes of these regulations without further testing.

2.8.3.3 Packing groups are assigned to corrosive substances in accordance with the following criteria (see table 2.8.3.4):

- .1 Packing group I is assigned to substances that cause irreversible damage of intact skin tissue within an observation period of up to 60 minutes starting after the exposure time of 3 minutes or less.
- .2 Packing group II is assigned to substances that cause irreversible damage of intact skin tissue within an observation period of up to 14 days starting after the exposure time of more than 3 minutes but not more than 60 minutes.
- .3 Packing group III is assigned to substances that:
 - .1 cause irreversible damage of intact skin tissue within an observation period up to 14 days starting after the exposure time of more than 60 minutes but not more than 4 hours; or
 - .2 are judged not to cause irreversible damage of intact skin tissue but which exhibit a corrosion rate on either steel or aluminium surfaces exceeding 6.25 mm a year at a test temperature of 55°C when tested on both materials. For the purposes of testing steel, type S235JR+CR (1.0037 resp. St 37-2), S275J2G3+CR (1.0144 resp. St 44-3), ISO 3574 or Unified Numbering System (UNS) G10200 or a similar type or SAE 1020, and for testing aluminium, non-clad, types 7075-T6 or AZ5GU-T6 shall be used. An acceptable test is prescribed in the Manual of Tests and Criteria, part III, section 37.
Note: Where an initial test on either steel or aluminium indicates the substance being tested is corrosive, the follow-up test on the other metal is not required.

Table 2.8.3.4: Table summarizing the criteria in 2.8.3.3

Packing Group	Exposure Time	Observation Period	Effect
I	≤ 3 min	≤ 60 min	Irreversible damage of intact skin
II	> 3 min ≤ 1 h	≤ 14 d	Irreversible damage of intact skin
III	> 1 h ≤ 4 h	≤ 14 d	Irreversible damage of intact skin
III	-	-	Corrosion rate on either steel or aluminium surfaces exceeding 6.25 mm a year at a test temperature of 55°C when tested on both materials

³ OECD Guideline for the testing of chemicals No. 430, *In Vitro* Skin Corrosion: Transcutaneous Electrical Resistance Test (TER) 2015.

⁴ OECD Guideline for the testing of chemicals No. 431, *In Vitro* Skin Corrosion: Human Skin Model Test 2015.

2.8.4 Alternative packing group assignment methods for mixtures: stepwise approach

2.8.4.1 General provisions

2.8.4.1.1 For mixtures it is necessary to obtain or derive information that allows the criteria to be applied to the mixture for the purpose of classification and assignment of packing groups. The approach to classification and assignment of packing groups is tiered, and is dependent upon the amount of information available for the mixture itself, for similar mixtures and/or for its ingredients. The flow chart of figure 2.8.4.1 below outlines the process to be followed:

Figure 2.8.4.1: Stepwise approach to classify and assign packing group of corrosive mixtures

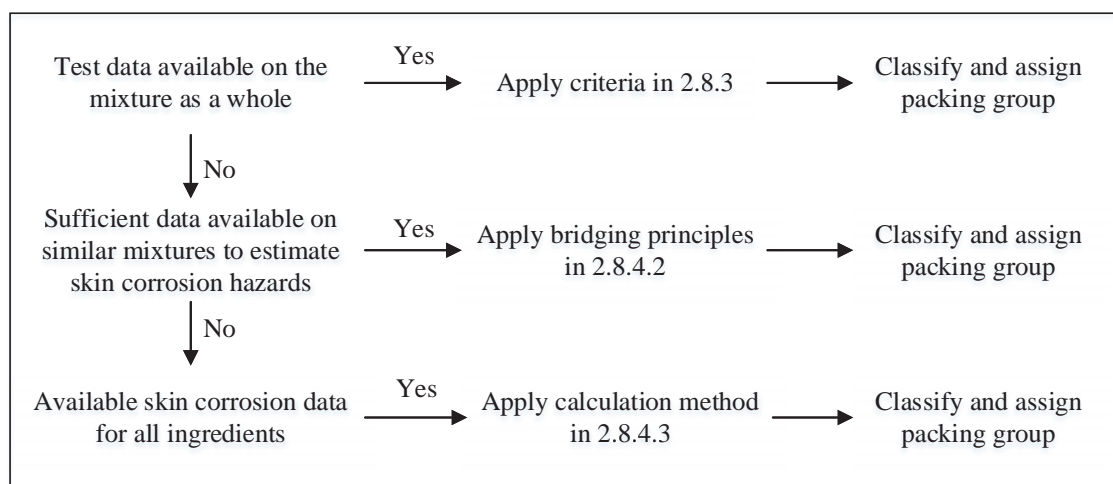

2.8.4.2 Bridging principles

2.8.4.2.1 Where a mixture has not been tested to determine its skin corrosion potential, but there are sufficient data on both the individual ingredients and similar tested mixtures to adequately classify and assign a packing group for the mixture, these data will be used in accordance with the following bridging principles. This ensures that the classification process uses the available data to the greatest extent possible in characterizing the hazards of the mixture.

- .1 **Dilution:** If a tested mixture is diluted with a diluent which does not meet the criteria for class 8 and does not affect the packing group of other ingredients, then the new diluted mixture may be assigned to the same packing group as the original tested mixture.

Note: in certain cases, diluting a mixture or substance may lead to an increase in the corrosive properties. If this is the case, this bridging principle cannot be used.

- .2 **Batching:** The skin corrosion potential of a tested production batch of a mixture can be assumed to be substantially equivalent to that of another untested production batch of the same commercial product when produced by or under the control of the same manufacturer, unless there is reason to believe there is significant variation such that the skin corrosion potential of the untested batch has changed. If the latter occurs, a new classification is necessary.

- .3 **Concentration of mixtures of packing group I:** If a tested mixture meeting the criteria for inclusion in packing group I is concentrated, the more concentrated untested mixture may be assigned to packing group I without additional testing.
- .4 **Interpolation within one packing group:** For three mixtures (A, B and C) with identical ingredients, where mixtures A and B have been tested and are in the same skin corrosion packing group, and where untested mixture C has the same class 8 ingredients as mixtures A and B but has concentrations of class 8 ingredients intermediate to the concentrations in mixtures A and B, then mixture C is assumed to be in the same skin corrosion packing group as A and B.
- .5 **Substantially similar mixtures:** Given the following:
 - .1 two mixtures: (A+B) and (C+B);
 - .2 the concentration of ingredient B is the same in both mixtures;
 - .3 the concentration of ingredient A in mixture (A+B) equals the concentration of ingredient C in mixture (C+B); and
 - .4 data on skin corrosion for ingredients A and C are available and substantially equivalent, i.e. they are the same skin corrosion packing group and do not affect the skin corrosion potential of B.

if mixture (A+B) or (C+B) is already classified based on test data, then the other mixture may be assigned to the same packing group.

2.8.4.3 Calculation method based on the classification of the substances

2.8.4.3.1 Where a mixture has not been tested to determine its skin corrosion potential, nor is sufficient data available on similar mixtures, the corrosive properties of the substances in the mixture shall be considered to classify and assign a packing group.

Applying the calculation method is only allowed if there are no synergistic effects that make the mixture more corrosive than the sum of its substances. This restriction applies only if packing group II or III would be assigned to the mixture.

2.8.4.3.2 When using the calculation method, all class 8 ingredients present at a concentration of $\geq 1\%$ shall be taken into account, or $< 1\%$ if these ingredients are still relevant for classifying the mixture to be corrosive to skin.

2.8.4.3.3 To determine whether a mixture containing corrosive substances shall be considered a corrosive mixture and to assign a packing group, the calculation method in the flow chart in figure 2.8.4.3 shall be applied.

2.8.4.3.4 When a specific concentration limit (SCL) is assigned to a substance following its entry in the Dangerous Goods List or in a special provision, this limit shall be used instead of the generic concentration limits (GCL). This appears where 1% is used in the first step for the assessment of the packing group I substances, and where 5% is used for the other steps respectively in figure 2.8.4.3.

2.8.4.3.5 For this purpose, the summation formula for each step of the calculation method shall be adapted. This means that, where applicable, the generic concentration limit shall be substituted by the specific concentration limit assigned to the substance(s) (SCL_i), and the adapted formula is a weighted average of the different concentration limits assigned to the different substances in the mixture:

$$\frac{PGx_1}{GCL} + \frac{PGx_2}{SCL_2} + \dots + \frac{PGx_i}{SCL_i} \geq 1$$

Where:

PG_{x_i} = concentration of substance 1, 2 ...i in the mixture, assigned to packing group x (I, II or III)

GCL = generic concentration limit

SCL_i = specific concentration limit assigned to substance i

The criterion for a packing group is fulfilled when the result of the calculation is ≥ 1 . The generic concentration limits to be used for the evaluation in each step of the calculation method are those found in figure 2.8.4.3.

Examples for the application of the above formula can be found in the note below.

Note: *Examples for the application of the above formula*

Example 1: A mixture contains one corrosive substance in a concentration of 5% assigned to packing group I without a specific concentration limit:

Calculation for packing group I: $\frac{5}{5 (GCL)} = 1 \rightarrow$ assign to class 8, packing group I.

Example 2: A mixture contains three substances corrosive to skin; two of them (A and B) have specific concentration limits; for the third one (C) the generic concentration limits applies. The rest of the mixture needs not to be taken into consideration.

Substance X in the mixture and its packing group assignment within class 8	Concentration (conc) in the mixture in %	Specific concentration limit (SCL) for packing group I	Specific concentration limit (SCL) for packing group II	Specific concentration limit (SCL) for packing group III
A, assigned to packing group I	3	30%	none	none
B, assigned to packing group I	2	20%	10%	none
C, assigned to packing group III	10	none	none	none

Calculation for packing group I: $\frac{3 (conc A)}{30 (SCL PGI)} + \frac{2 (conc B)}{20 (SCL PGI)} = 0,2 < 1$

The criterion for packing group I is not fulfilled.

Calculation for packing group II: $\frac{3 (\text{conc A})}{5 (\text{GCL PG II})} + \frac{2 (\text{conc B})}{10 (\text{SCL PG II})} = 0,8 < 1$

The criterion for packing group II is not fulfilled.

Calculation for packing group III: $\frac{3 (\text{conc A})}{5 (\text{GCL PGIII})} + \frac{2 (\text{conc B})}{5 (\text{GCL PG III})} + \frac{10 (\text{conc C})}{5 \text{GCL PG III}} = 3 \geq 1$

The criterion for packing group III is fulfilled, the mixture shall be assigned to class 8, packing group III.

Figure 2.8.4.3: Calculation method

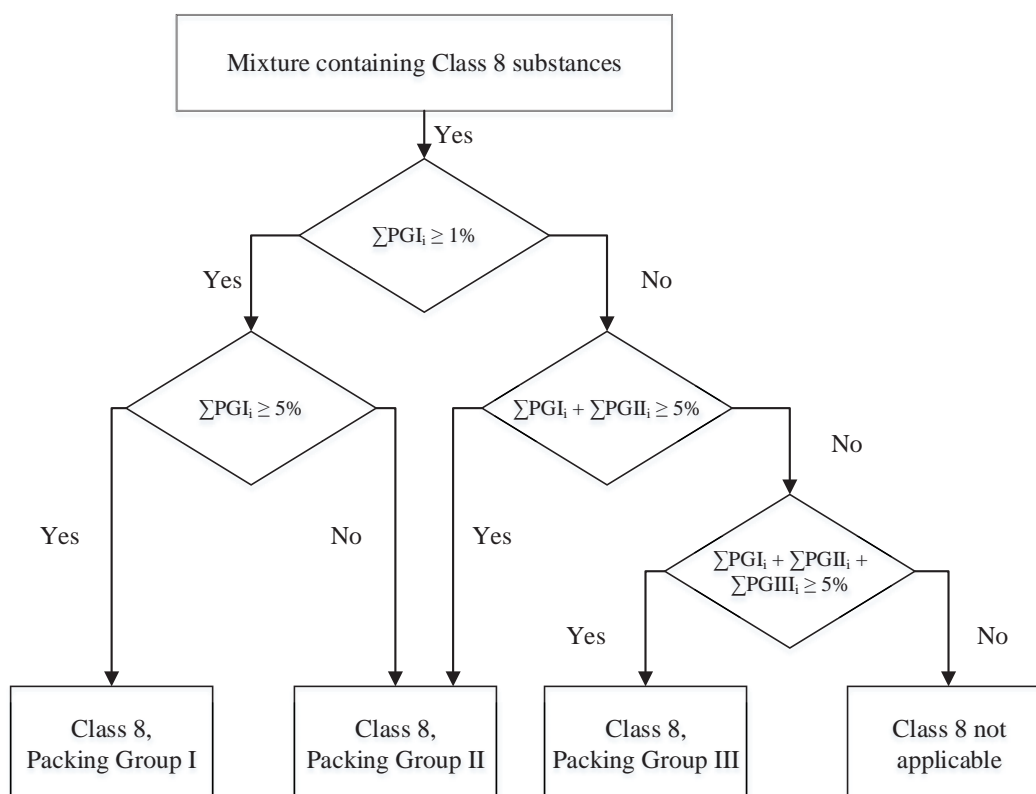

2.8.5 Substances not accepted for transport

Chemically unstable substances of class 8 shall not be accepted for transport unless the necessary precautions have been taken to prevent the possibility of a dangerous decomposition or polymerization under normal conditions of transport. For the precautions necessary to prevent polymerization, see special provision 386 of chapter 3.3. To this end particular care shall be taken to ensure that receptacles and tanks do not contain any substances liable to promote these reactions.

..

Chapter 2.9

Miscellaneous dangerous substances and articles (class 9) and environmentally hazardous substances

2.9.2 Assignment to class 9

2.9.2.2 Under the heading "Lithium batteries", add the following new entry:

"3536 LITHIUM BATTERIES INSTALLED IN CARGO TRANSPORT UNIT".

Before the heading "Other substances or articles presenting a danger during transport, but not meeting the definitions of another class", insert the following new sub-division:

"Ammonium nitrate based fertilizers

2071 AMMONIUM NITRATE BASED FERTILIZER

Solid ammonium nitrate based fertilizers shall be classified in accordance with the procedure as set out in the Manual of Tests and Criteria, part III, section 39."

Under the heading "Other substances or articles presenting a danger during transport, but not meeting the definitions of another class", delete entry "2071 AMMONIUM NITRATE BASED FERTILIZER" and add the following new entry at the end of the list:

"3548 ARTICLES CONTAINING MISCELLANEOUS DANGEROUS GOODS N.O.S."

2.9.3 Environmentally hazardous substances (aquatic environment)

2.9.3.4.6.5 *Classification of mixtures with ingredients without any useable information*

2.9.3.4.6.5.1 At the end of the paragraph, delete the words "with the additional statement that: "x percent of the mixture consists of ingredients(s) of unknown hazards to the aquatic environment"".

2.9.4 Lithium batteries

Add the following new sub-paragraphs .6 and .7:

".6 Lithium batteries, containing both primary lithium metal cells and rechargeable lithium ion cells, that are not designed to be externally charged (see special provision 387 of chapter 3.3) shall meet the following conditions:

- .1 the rechargeable lithium ion cells can only be charged from the primary lithium metal cells;
- .2 overcharge of the rechargeable lithium ion cells is precluded by design;
- .3 the battery has been tested as a lithium primary battery; and
- .4 component cells of the battery shall be of a type proved to meet the respective testing requirements of the Manual of Tests and Criteria, part III, subsection 38.3.

- .7 Manufacturers and subsequent distributors of cells or batteries shall make available the test summary as specified in the Manual of Tests and Criteria, part III, subsection 38.3, paragraph 38.3.5."

PART 3 DANGEROUS GOODS LIST, SPECIAL PROVISIONS AND EXCEPTIONS

Chapter 3.1 General

3.1.1 Scope and general provisions

- 3.1.1.2 At the end of the last sentence, replace "risks" with "hazards".

3.1.2 Proper shipping names

- 3.1.2.2 In the paragraph, amend the first sentence to read as follows:

"When a combination of several distinct proper shipping names are listed under a single UN number, and these are separated by "and" or "or" in lower case or are punctuated by commas, only the most appropriate shall be shown in the transport document and package marks.",

and delete the second sentence.

- 3.1.2.6 Add a new sub-paragraph .2 as follows:

".2 Unless it is already included in capital letters in the name indicated in the Dangerous Goods List, the words "TEMPERATURE CONTROLLED" shall be added as part of the proper shipping name.",

and renumber the existing sub-paragraph .2 as .3.

3.1.2.8 Generic or "not otherwise specified" (N.O.S.) entries

- 3.1.2.8.1.2 Amend the first sentence to read as follows:

"When a mixture of dangerous goods or articles containing dangerous goods are described by one of the "N.O.S." or "generic" entries to which special provision 274 has been allocated in the Dangerous Goods List, not more than the two constituents which most predominantly contribute to the hazard or hazards of the mixture or of the articles need to be shown, excluding controlled substances when their disclosure is prohibited by national law or international convention.",

and in the second sentence, replace "risk" with "hazard" twice.

- 3.1.2.8.1.3 Add the following new example at the end of the paragraph:

"UN 3540 ARTICLES CONTAINING FLAMMABLE LIQUID, N.O.S. (pyrrolidine)".

3.1.3 Mixtures or solutions

- 3.1.3.2.3 Replace "risk(s)" with "hazard(s)".

3.1.3.4 Replace "subsidiary risk(s)" with "subsidiary hazard(s)".

3.1.4 Segregation groups

3.1.4.1 Amend the paragraph to read as follows:

"3.1.4.1 For the purpose of segregation, dangerous goods having certain similar chemical properties have been grouped together in segregation groups, see 7.2.5."

3.1.4.4 Amend the headings to read as follows:

- 1 Acids (SGG1 or SGG1a)
- 2 Ammonium compounds (SGG2)
- 3 Bromates (SGG3)
- 4 Chlorates (SGG4)
- 5 Chlorites (SGG5)
- 6 Cyanides (SGG6)
- 7 Heavy metals and their salts (including their organometallic compounds) (SGG7)
- 8 Hypochlorites (SGG8)
- 9 Lead and its compounds (SGG9)
- 10 Liquid halogenated hydrocarbons (SGG10)
- 11 Mercury and mercury compounds (SGG11)
- 12 Nitrites and their mixtures (SGG12)
- 13 Perchlorates (SGG13)
- 14 Permanganates (SGG14)
- 15 Powdered metals (SGG15)
- 16 Peroxides (SGG16)
- 17 Azides (SGG17)
- 18 Alkalis (SGG18)

3.1.4.4 Under "3 Bromates", delete the entry "3213 Ammonium bromate". Under "7 Heavy metals and their salts (including their organometallic compounds)", delete the entries "1366 Diethylzinc" and "1370 Dimethylzinc".

Chapter 3.2 Dangerous Goods List

3.2.1 Structure of the Dangerous Goods List

In the description of column 4, replace "subsidiary risk(s)" with "subsidiary hazard(s)" twice.

In the description of column 15, add "Revised" before the word "Emergency".

In the description of column 16b, insert "the segregation group codes as specified in 7.2.5.2 and" after "contains".

Dangerous Goods List

In the Dangerous Goods List, in the heading of column 4, replace "risk" with "hazard", and amend the following entries:

0004	in column 16b, insert "SGG2"
0005	in column 16a, amend "Category 05" to "Category 03"
0006	in column 16a, amend "Category 04" to "Category 03"
0007	in column 16a, amend "Category 05" to "Category 03"
0033	in column 16a, amend "Category 05" to "Category 03"
0034	in column 16a, amend "Category 04" to "Category 03"
0035	in column 16a, amend "Category 04" to "Category 03"
0037	in column 16a, amend "Category 05" to "Category 03"
0038	in column 16a, amend "Category 04" to "Category 03"
0042	in column 16a, amend "Category 04" to "Category 03"
0043	in column 16a, amend "Category 04" to "Category 03"
0048	in column 16a, amend "Category 04" to "Category 03"
0056	in column 16a, amend "Category 04" to "Category 03"
0059	in column 16a, amend "Category 04" to "Category 03"
0060	in column 16a, amend "Category 04" to "Category 03"
0065	in column 16a, amend "Category 04" to "Category 03"
0099	in column 16a, amend "Category 04" to "Category 03"
0102	in column 16a, amend "Category 04" to "Category 03"
0124	in column 16a, amend "Category 04" to "Category 03" and insert "SW30"
0129	in column 16b, insert "SGG7", "SGG9" and "SGG17"
0130	in column 16b, insert "SGG7" and "SGG9"
0135	in column 16b, insert "SGG7" and "SGG11"
0136	in column 16a, amend "Category 05" to "Category 03"
0137	in column 16a, amend "Category 04" to "Category 03"
0138	in column 16a, amend "Category 04" to "Category 03"
0167	in column 16a, amend "Category 05" to "Category 03"
0168	in column 16a, amend "Category 04" to "Category 03"
0169	in column 16a, amend "Category 04" to "Category 03"
0180	in column 16a, amend "Category 05" to "Category 03"
0181	in column 16a, amend "Category 04" to "Category 03"
0182	in column 16a, amend "Category 04" to "Category 03"
0183	in column 16a, amend "Category 04" to "Category 03"
0186	in column 16a, amend "Category 04" to "Category 03"
0204	in column 16a, amend "Category 05" to "Category 03"
0221	in column 16a, amend "Category 04" to "Category 03"
0222	in column 16b, insert "SGG2"
0224	in column 16b, insert "SGG17"
0242	in column 16a, amend "Category 04" to "Category 03"
0271	in column 16a, amend "Category 04" to "Category 03"
0272	in column 16a, amend "Category 04" to "Category 03"
0275	in column 16a, amend "Category 04" to "Category 03"
0277	in column 16a, amend "Category 04" to "Category 03"
0279	in column 16a, amend "Category 04" to "Category 03"
0280	in column 16a, amend "Category 04" to "Category 03"
0283	in column 16a, amend "Category 04" to "Category 03"
0284	in column 16a, amend "Category 04" to "Category 03"
0285	in column 16a, amend "Category 04" to "Category 03"

0286	in column 16a, amend "Category 04" to "Category 03"
0287	in column 16a, amend "Category 04" to "Category 03"
0290	in column 16a, amend "Category 04" to "Category 03"
0291	in column 16a, amend "Category 05" to "Category 03"
0292	in column 16a, amend "Category 05" to "Category 03"
0293	in column 16a, amend "Category 05" to "Category 03"
0294	in column 16a, amend "Category 05" to "Category 03"
0295	in column 16a, amend "Category 05" to "Category 03"
0296	in column 16a, amend "Category 05" to "Category 03"
0321	in column 16a, amend "Category 04" to "Category 03"
0324	in column 16a, amend "Category 05" to "Category 03"
0326	in column 16a, amend "Category 04" to "Category 03"
0327	in column 16a, amend "Category 04" to "Category 03"
0328	in column 16a, amend "Category 04" to "Category 03"
0329	in column 16a, amend "Category 04" to "Category 03"
0330	in column 16a, amend "Category 05" to "Category 03"
0346	in column 16a, amend "Category 04" to "Category 03"
0348	in column 16a, amend "Category 05" to "Category 03"
0349	in column 6, insert "347"
0367	in column 6, insert "347"
0369	in column 16a, amend "Category 05" to "Category 03"
0371	in column 16a, amend "Category 05" to "Category 03"
0374	in column 16a, amend "Category 04" to "Category 03"
0375	in column 16a, amend "Category 04" to "Category 03"
0381	in column 16a, amend "Category 04" to "Category 03"
0384	in column 6, insert "347"
0402	in column 16b, insert "SGG2"
0408	in column 16a, amend "Category 04" to "Category 03"
0409	in column 16a, amend "Category 04" to "Category 03"
0413	in column 16a, amend "Category 04" to "Category 03"
0414	in column 16a, amend "Category 04" to "Category 03"
0415	in column 16a, amend "Category 04" to "Category 03"
0417	in column 16a, amend "Category 04" to "Category 03"
0426	in column 16a, amend "Category 05" to "Category 03"
0427	in column 16a, amend "Category 05" to "Category 03"
0436	in column 16a, amend "Category 04" to "Category 03"
0437	in column 16a, amend "Category 04" to "Category 03"
0439	in column 16a, amend "Category 04" to "Category 03"
0442	in column 16a, amend "Category 04" to "Category 03"
0443	in column 16a, amend "Category 04" to "Category 03"
0447	in column 16a, amend "Category 04" to "Category 03"
0451	in column 16a, amend "Category 04" to "Category 03"
0457	in column 16a, amend "Category 04" to "Category 03"
0458	in column 16a, amend "Category 04" to "Category 03"
0462	in column 16a, amend "Category 04" to "Category 03"
0463	in column 16a, amend "Category 04" to "Category 03"
0464	in column 16a, amend "Category 04" to "Category 03"
0465	in column 16a, amend "Category 05" to "Category 03"
0466	in column 16a, amend "Category 04" to "Category 03"
0467	in column 16a, amend "Category 04" to "Category 03"
0468	in column 16a, amend "Category 04" to "Category 03"
0469	in column 16a, amend "Category 05" to "Category 03"

0470	in column 16a, amend "Category 04" to "Category 03"
0472	in column 16a, amend "Category 05" to "Category 03"
0481	in column 6, insert "347"
0494	in column 16a, insert "SW30"
0502	in column 16a, amend "Category 04" to "Category 03"
1005	in column 16b, insert "SGG18"
1011	in column 6, insert "392"
1016	in column 6, insert "974"
1032	in column 16b, insert "SG35"
1036	in column 16b, insert "SG35"
1046	in column 6, insert "974"
1049	in column 6, insert "392" and "974"
1052	in column 16b, insert "SGG1a", "SG36" and "SG49"
1061	in column 16b, insert "SG35"
1075	in column 6, insert "392"
1083	in column 16b, insert "SG35"
1099	in column 16b, insert "SGG10"
1100	in column 16b, insert "SGG10"
1106 PG II	in column 16b, insert "SG35"
1106 PG III	in column 16b, insert "SG35"
1107	in column 16b, insert "SGG10"
1125	in column 16b, insert "SG35"
1126	in column 16b, insert "SGG10"
1127	in column 16b, insert "SGG10"
1134	in column 16b, insert "SGG10"
1150	in column 16b, insert "SGG10"
1152	in column 16b, insert "SGG10"
1154	in column 16b, insert "SG35"
1158	in column 16b, insert "SG35"
1160	in column 16b, insert "SGG18"
1163	in column 16b, insert "SGG18"
1182	in column 16b, insert "SGG1", "SG36" and "SG49"
1183	in column 16b, insert "SGG1", "SG36" and "SG49"
1184	in column 16b, insert "SGG10"
1214	in column 16b, insert "SG35"
1221	in column 16b, insert "SG35"
1235	in column 16b, insert "SGG18"
1238	in column 16b, insert "SGG1", "SG36" and "SG49"
1242	in column 16b, insert "SGG1", "SG36" and "SG49"
1244	in column 16b, insert "SGG18"
1250	in column 16b, insert "SGG1", "SG36" and "SG49"
1277	in column 16b, insert "SG35"
1278	in column 16b, insert "SGG10"
1279	in column 16b, insert "SGG10"
1295	in column 16b, insert "SGG1", "SG36" and "SG49"
1296	in column 16b, insert "SG35"
1297 PG I	in column 16b, insert "SG35"
1297 PG II	in column 16b, insert "SG35"

1297 PG III	in column 16b, insert "SG35"
1298	in column 16b, insert "SGG1", "SG36" and "SG49"
1303	in column 16b, insert "SGG10"
1305	in column 16b, insert "SGG1", "SG36" and "SG49"
1309 PG II	in column 16b, insert "SGG15"
1309 PG III	in column 16b, insert "SGG15"
1310	in column 16b, insert "SGG2"
1325 PG II	in column 16b, insert "SG72"
1325 PG III	in column 16b, insert "SG72"
1326	in column 16b, insert "SGG15"
1327	in column 6, insert "973"
1347	in column 16b, insert "SGG7"
1352	in column 16b, insert "SGG15"
1358	in column 16b, insert "SGG15"
1363	in column 6, insert "973"
1364	in column 6, insert "973"
1365	in column 6, insert "973"
1382	in column 16b, insert "SGG18"
1383	in column 16b, insert "SGG15"
1385	in column 16b, insert "SGG18"
1386 (both entries)	in column 6, insert "973"
1389	in column 16b, insert "SGG7" and "SGG11"
1392	in column 16b, insert "SGG7" and "SGG11"
1396 PG II	in column 16b, insert "SGG15"
1396 PG III	in column 16b, insert "SGG15"
1398	in column 16b, insert "SGG15"
1418 PG I	in column 16b, insert "SGG15"
1418 PG II	in column 16b, insert "SGG15"
1418 PG III	in column 16b, insert "SGG15"
1435	in column 16b, insert "SGG7" and "SGG15"
1436 PG I	in column 16b, insert "SGG7" and "SGG15"
1436 PG II	in column 16b, insert "SGG7" and "SGG15"
1436 PG III	in column 16b, insert "SGG7" and "SGG15"
1439	in column 16b, insert "SGG2"
1442	in column 16b, insert "SGG2" and "SGG13"
1444	in column 16b, insert "SGG2"
1445	in column 16b, insert "SGG4"
1447	in column 16b, insert "SGG13"

1448	in column 16b, insert "SGG14"
1449	in column 16b, insert "SGG16"
1450	in column 16b, insert "SGG3"
1452	in column 16b, insert "SGG4"
1453	in column 16b, insert "SGG5"
1455	in column 16b, insert "SGG13"
1456	in column 16b, insert "SGG14"
1457	in column 16b, insert "SGG16"
1458 PG II	in column 16b, insert "SGG4"
1458 PG III	in column 16b, insert "SGG4"
1459 PG II	in column 16b, insert "SGG4"
1459 PG III	in column 16b, insert "SGG4"
1461	in column 16b, insert "SGG4"
1462	in column 16b, insert "SGG5"
1469	in column 16b, insert "SGG7", "SGG9"
1470	in column 16b, insert "SGG7", "SGG9" and "SGG13"
1471 PG II	in column 16b, insert "SGG8"
1471 PG III	in column 16b, insert "SGG8"
1472	in column 16b, insert "SGG16"
1473	in column 16b, insert "SGG3"
1475	in column 16b, insert "SGG13"
1476	in column 16b, insert "SGG16"
1481 PG II	in column 16b, insert "SGG13"
1481 PG III	in column 16b, insert "SGG13"
1482 PG II	in column 16b, insert "SGG14"
1482 PG III	in column 16b, insert "SGG14"
1483 PG II	in column 16b, insert "SGG16"
1483 PG III	in column 16b, insert "SGG16"
1484	in column 16b, insert "SGG3"
1485	in column 16b, insert "SGG4"
1487	in column 16b, insert "SGG12"
1488	in column 16b, insert "SGG12"
1489	in column 16b, insert "SGG13"
1490	in column 16b, insert "SGG14"
1491	in column 16b, insert "SGG16"
1493	in column 16b, insert "SGG7"
1494	in column 16b, insert "SGG3"
1495	in column 16b, insert "SGG4"
1496	in column 16b, insert "SGG5"
1500	in column 16b, insert "SGG12"

1502	in column 16b, insert "SGG13"
1503	in column 16b, insert "SGG14"
1504	in column 16b, insert "SGG16"
1506	in column 16b, insert "SGG4"
1508	in column 16b, insert "SGG13"
1509	in column 16b, insert "SGG16"
1512	in column 16b, insert "SGG2", "SGG7" and "SGG12"
1513	in column 16b, insert "SGG4" and "SGG7"
1514	in column 16b, insert "SGG7"
1515	in column 16b, insert "SGG7" and "SGG14"
1516	in column 16b, insert "SGG7" and "SGG16"
1541	in column 16b, insert "SGG6"
1546	in column 16b, insert "SGG2"
1565	in column 16b, insert "SGG6"
1571	in column 16b, insert "SGG17"
1572	in column 16b, insert "SGG1", "SG36" and "SG49"
1575	in column 16b, insert "SGG6"
1587	in column 16b, insert "SGG6" and "SGG7"
1588 PG I	in column 16b, insert "SGG6"
1588 PG II	in column 16b, insert "SGG6"
1588 PG III	in column 16b, insert "SGG6"
1591	in column 16b, insert "SGG10"
1593	in column 16b, insert "SGG10"
1595	in column 16b, insert "SGG1", "SG36" and "SG49"
1604	in column 16b, insert "SGG18"
1605	in column 16b, insert "SGG10"
1616	in column 16b, insert "SGG7" and "SGG9"
1617	in column 16b, insert "SGG7" and "SGG9"
1618	in column 16b, insert "SGG7" and "SGG9"
1620	in column 16b, insert "SGG6", "SGG7" and "SGG9"
1623	in column 16b, insert "SGG7" and "SGG11"
1624	in column 16b, insert "SGG7" and "SGG11"
1625	in column 16b, insert "SGG7" and "SGG11"
1626	in column 16b, insert "SGG6", "SGG7" and "SGG11"
1627	in column 16b, insert "SGG7" and "SGG11"
1629	in column 16b, insert "SGG7" and "SGG11"
1630	in column 16b, insert "SGG2", "SGG7" and "SGG11"
1631	in column 16b, insert "SGG7" and "SGG11"
1634	in column 16b, insert "SGG7" and "SGG11"
1636	in column 16b, insert "SGG6", "SGG7" and "SGG11"
1637	in column 16b, insert "SGG7" and "SGG11"
1638	in column 16b, insert "SGG7" and "SGG11"
1639	in column 16b, insert "SGG7" and "SGG11"
1640	in column 16b, insert "SGG7" and "SGG11"
1641	in column 16b, insert "SGG7" and "SGG11"
1642	in column 16b, insert "SGG6", "SGG7" and "SGG11"
1643	in column 16b, insert "SGG7" and "SGG11"
1644	in column 16b, insert "SGG7" and "SGG11"
1645	in column 16b, insert "SGG7" and "SGG11"

1646	in column 16b, insert "SGG7" and "SGG11"
1647	in column 16b, insert "SGG10"
1649	in column 16b, insert "SGG7" and "SGG9"
1653	in column 16b, insert "SGG6" and "SGG7"
1669	in column 16b, insert "SGG10"
1674	in column 16b, insert "SGG7"
1679	in column 16b, insert "SGG6"
1680	in column 16b, insert "SGG6"
1683	in column 16b, insert "SGG7"
1684	in column 16b, insert "SGG6" and "SGG7"
1687	in column 16b, insert "SGG17"
1689	in column 16b, insert "SGG6"
1694	in column 16b, insert "SGG6"
1701	in column 16b, insert "SGG10"
1702	in column 16b, insert "SGG10"
1710	in column 16b, insert "SGG10"
1712	in column 16b, insert "SGG7"
1713	in column 16b, insert "SGG6" and "SGG7"
1714	in column 16b, insert "SGG7"
1715	in column 16b, insert "SGG1", "SG36" and "SG49"
1716	in column 16b, insert "SGG1", "SG36" and "SG49"
1717	in column 16b, insert "SGG1", "SG36" and "SG49"
1718	in column 16b, insert "SGG1", "SG36" and "SG49"
1719 PGII	in column 16b, insert "SGG18"
1719 PGIII	in column 16b, insert "SGG18"
1722	in column 16b, insert "SGG1", "SG36" and "SG49"
1723	in column 16b, insert "SGG1", "SGG10", "SG36" and "SG49"
1724	in column 16b, insert "SGG1", "SG36" and "SG49"
1725	in column 16b, insert "SGG1", "SG36" and "SG49"
1726	in column 16b, insert "SGG1", "SG36" and "SG49"
1727	in column 16b, insert "SGG1", "SGG2", "SG36" and "SG49"
1728	in column 16b, insert "SGG1", "SG36" and "SG49"
1729	in column 16b, insert "SGG1", "SG36" and "SG49"
1730	in column 16b, insert "SGG1", "SG36" and "SG49"
1731 PG II	in column 16b, insert "SGG1", "SG36" and "SG49"
1731 PG III	in column 16b, insert "SGG1", "SG36" and "SG49"
1732	in column 16b, insert "SGG1", "SG36" and "SG49"
1733	in column 16b, insert "SGG1", "SG36" and "SG49"
1736	in column 16b, insert "SGG1", "SG36" and "SG49"
1737	in column 16b, insert "SGG1", "SGG10", "SG36" and "SG49"
1738	in column 16b, insert "SGG1", "SGG10", "SG36" and "SG49"
1739	in column 16b, insert "SGG1", "SG36" and "SG49"
1740 PG II	in column 16b, insert "SGG1", "SG36" and "SG49"
1740 PG III	in column 16b, insert "SGG1", "SG36" and "SG49"
1742	in column 16b, insert "SGG1", "SG36" and "SG49"
1743	in column 16b, insert "SGG1", "SG36" and "SG49"

1744	in column 16b, insert "SGG1", "SG36" and "SG49"
1745	in column 16b, insert "SGG1", "SG36" and "SG49"
1746	in column 16b, insert "SGG1", "SG36" and "SG49"
1747	in column 16b, insert "SGG1", "SG36" and "SG49"
1748	in column 16b, insert "SGG8"
1750	in column 16b, insert "SGG1", "SG36" and "SG49"
1751	in column 16b, insert "SGG1", "SG36" and "SG49"
1752	in column 16b, insert "SGG1", "SG36" and "SG49"
1753	in column 16b, insert "SGG1", "SG36" and "SG49"
1754	in column 16b, insert "SGG1", "SG36" and "SG49"
1755 PG II	in column 16b, insert "SGG1", "SG36" and "SG49"
1755 PG III	in column 16b, insert "SGG1", "SG36" and "SG49"
1756	in column 16b, insert "SGG1", "SG36" and "SG49"
1757 PG II	in column 16b, insert "SGG1", "SG36" and "SG49"
1757 PG III	in column 16b, insert "SGG1", "SG36" and "SG49"
1758	in column 16b, insert "SGG1", "SG36" and "SG49"
1761 PG II	in column 16b, insert "SG35"
1761 PG III	in column 16b, insert "SG35"
1762	in column 16b, insert "SGG1", "SG36" and "SG49"
1763	in column 16b, insert "SGG1", "SG36" and "SG49"
1764	in column 16b, insert "SGG1", "SG36" and "SG49"
1765	in column 16b, insert "SGG1", "SG36" and "SG49"
1766	in column 16b, insert "SGG1", "SG36" and "SG49"
1767	in column 16b, insert "SGG1", "SG36" and "SG49"
1768	in column 16b, insert "SGG1", "SG36" and "SG49"
1769	in column 16b, insert "SGG1", "SG36" and "SG49"
1770	in column 16b, insert "SGG1", "SG36" and "SG49"
1771	in column 16b, insert "SGG1", "SG36" and "SG49"
1773	in column 16b, insert "SGG1", "SG36" and "SG49"
1775	in column 16b, insert "SGG1", "SG36" and "SG49"
1776	in column 16b, insert "SGG1", "SG36" and "SG49"
1777	in column 16b, insert "SGG1a", "SG36" and "SG49"
1778	in column 16b, insert "SGG1", "SG36" and "SG49"
1779	in column 16b, insert "SGG1", "SG36" and "SG49"
1780	in column 16b, insert "SGG1", "SG36" and "SG49"
1781	in column 16b, insert "SGG1", "SG36" and "SG49"
1782	in column 16b, insert "SGG1", "SG36" and "SG49"
1783 PG II	in column 16b, insert "SG35"
1783 PG III	in column 16b, insert "SG35"
1784	in column 16b, insert "SGG1", "SG36" and "SG49"
1786	in column 16b, insert "SGG1a", "SG36" and "SG49"
1787 PG II	in column 16b, insert "SGG1a", "SG36" and "SG49"

1787 PG III	in column 16b, insert "SGG1a", "SG36" and "SG49"
1788 PG II	in column 16b, insert "SGG1a", "SG36" and "SG49"
1788 PG III	in column 16b, insert "SGG1a", "SG36" and "SG49"
1789 PG II	in column 16b, insert "SGG1a", "SG36" and "SG49"
1789 PG III	in column 16b, insert "SGG1a", "SG36" and "SG49"
1790 PG I	in column 16b, insert "SGG1a", "SG36" and "SG49"
1790 PG II	in column 16b, insert "SGG1a", "SG36" and "SG49"
1791 PG II	in column 6, insert "274" and "900"; in column 16b, insert "SGG8"
1791 PG III	in column 6, insert "274" and "900"; in column 16b, insert "SGG8"
1792	in column 16b, insert "SGG1", "SG36" and "SG49"
1793	in column 16b, insert "SGG1", "SG36" and "SG49"
1794	in column 16b, insert "SGG1", "SGG7", "SGG9", "SG36" and "SG49"
1796 PG I	in column 16b, insert "SGG1a", "SG36" and "SG49"
1796 PG II	in column 16b, insert "SGG1a", "SG36" and "SG49"
1798	in column 16b, insert "SGG1a", "SG36" and "SG49"
1799	in column 16b, insert "SGG1", "SG36" and "SG49"
1800	in column 16b, insert "SGG1", "SG36" and "SG49"
1801	in column 16b, insert "SGG1", "SG36" and "SG49"
1802	in column 16b, insert "SGG1a", "SG36" and "SG49"
1803	in column 16b, insert "SGG1", "SG36" and "SG49"
1804	in column 16b, insert "SGG1", "SG36" and "SG49"
1805	in column 16b, insert "SGG1", "SG36" and "SG49"
1806	in column 16b, insert "SGG1", "SG36" and "SG49"
1807	in column 16b, insert "SGG1", "SG36" and "SG49"
1808	in column 16b, insert "SGG1", "SG36" and "SG49"
1809	in column 16b, insert "SGG1", "SG36" and "SG49"
1810	in column 16b, insert "SGG1", "SG36" and "SG49"
1811	in column 16b, insert "SGG1", "SG36" and "SG49"
1813	in column 16b, insert "SGG18"
1814 PG II	in column 16b, insert "SGG18"
1814 PG III	in column 16b, insert "SGG18"
1815	in column 16b, insert "SGG1", "SG36" and "SG49"
1816	in column 16b, insert "SGG1", "SG36" and "SG49"
1817	in column 16b, insert "SGG1", "SG36" and "SG49"
1818	in column 16b, insert "SGG1", "SG36" and "SG49"
1819 PG II	in column 16b, insert "SGG18"
1819 PG III	in column 16b, insert "SGG18"

1823	in column 16b, insert "SGG18"
1824 PG II	in column 16b, insert "SGG18"
1824 PG III	in column 16b, insert "SGG18"
1825	in column 16b, insert "SGG18"
1826 PG I	in column 16b, insert "SGG1a", "SG36" and "SG49"
1826 PG II	in column 16b, insert "SGG1a", "SG36" and "SG49"
1827	in column 16b, insert "SGG1", "SG36" and "SG49"
1828	in column 16b, insert "SGG1", "SG36" and "SG49"
1829	in column 16b, insert "SGG1", "SG36" and "SG49"
1830	in column 16b, insert "SGG1a", "SG36" and "SG49"
1831	in column 16b, insert "SGG1a", "SG36" and "SG49"
1832	in column 16b, insert "SGG1a", "SG36" and "SG49"
1833	in column 16b, insert "SGG1", "SG36" and "SG49"
1834	in column 16b, insert "SGG1", "SG36" and "SG49"
1835 PG II	in column 16b, insert "SGG2" and "SGG18"
1835 PG III	in column 16b, insert "SGG2" and "SGG18"
1836	in column 16b, insert "SGG1", "SG36" and "SG49"
1837	in column 16b, insert "SGG1", "SG36" and "SG49"
1838	in column 16b, insert "SGG1", "SGG7", "SG36" and "SG49"
1839	in column 16b, insert "SGG1", "SG36" and "SG49"
1840	in column 16b, insert "SGG1", "SGG7", "SG36" and "SG49"
1843	in column 16b, insert "SGG2"
1846	in column 16b, insert "SGG10"
1847	in column 16b, insert "SGG18"
1848	in column 16b, insert "SGG1", "SG36" and "SG49"
1849	in column 16b, insert "SGG18"
1854	in column 16b, insert "SGG15"
1856	in column 6, insert "973"
1872	in column 16b, insert "SGG7" and "SGG9"
1873	in column 16b, insert "SGG1a", "SG36" and "SG49"
1887	in column 16b, insert "SGG10"
1888	in column 16b, insert "SGG10"
1889	in column 16b, insert "SGG6"
1891	in column 16b, insert "SGG10"
1894	in column 16b, insert "SGG7" and "SGG11"
1895	in column 16b, insert "SGG7" and "SGG11"
1897	in column 16b, insert "SGG10"
1898	in column 16b, insert "SGG1", "SG36" and "SG49"
1902	in column 16b, insert "SGG1", "SG36" and "SG49"
1905	in column 16b, insert "SGG1", "SG36" and "SG49"
1906	in column 16b, insert "SGG1a", "SG36" and "SG49"
1907	in column 16b, insert "SGG18"
1908 PGII	in column 6, insert "274" and "352"; in column 16b, insert "SGG5"
1908 PGIII	in column 6, insert "274" and "352"; in column 16b, insert "SGG5"

1922	in column 16b, insert "SGG18"
1931	in column 16b, insert "SGG7"
1935 PG I	in column 16b, insert "SGG6"
1935 PG II	in column 16b, insert "SGG6"
1935 PG III	in column 16b, insert "SGG6"
1938 PG II	in column 16b, insert "SGG1", "SG36" and "SG49"
1938 PG III	in column 16b, insert "SGG1", "SG36" and "SG49"
1939	in column 16b, insert "SGG1", "SG36" and "SG49"
1940	in column 16b, insert "SGG1", "SG36" and "SG49"
1942	in column 16b, insert "SGG2"
1945	in column 6, add "293"
1954	in column 6, insert "392"
1965	in column 6, insert "392"
1969	in column 6, insert "392"
1971	in column 6, insert "392" and "974"
1978	in column 6, insert "392"
1991	in column 16b, insert "SGG10"
2008 PG I	in column 16b, insert "SGG15"
2008 PG II	in column 16b, insert "SGG15"
2008 PG III	in column 16b, insert "SGG15"
2009	in column 16b, insert "SGG15"
2014	in column 16b, insert "SGG16"
2015	in column 16b, insert "SGG16"
2024 PG I	in column 16b, insert "SGG7" and "SGG11"
2024 PG II	in column 16b, insert "SGG7" and "SGG11"
2024 PG III	in column 16b, insert "SGG7" and "SGG11"
2025 PG I	in column 16b, insert "SGG7" and "SGG11"
2025 PG II	in column 16b, insert "SGG7" and "SGG11"
2025 PG III	in column 16b, insert "SGG7" and "SGG11"
2026 PG I	in column 16b, insert "SGG7" and "SGG11"
2026 PG II	in column 16b, insert "SGG7" and "SGG11"
2026 PG III	in column 16b, insert "SGG7" and "SGG11"
2029	in column 16b, insert "SGG18"
2030 PG I	in column 16b, insert "SGG18"

2030 PG II	in column 16b, insert "SGG18"
2030 PG III	in column 16b, insert "SGG18"
2031 PG I	in column 16b, insert "SGG1a", "SG36" and "SG49"
2031 PG II (both entries)	in column 16b, insert "SGG1a", "SG36" and "SG49"
2032	in column 16b, insert "SGG1a", "SG36" and "SG49"
2033	in column 16b, insert "SGG18"
2051	in column 16b, insert "SG35"
2067	in column 6, delete "186"; in column 16b, insert "SGG2"
2071	in column 6, delete "186"; in column 16b, insert "SGG2"
2073	in column 16b, insert "SGG2" and "SGG18"
2079	in column 16b, insert "SGG18"
2205	in column 16b, insert "SGG6"
2208	in column 16b, insert "SGG8"
2214	in column 16b, insert "SGG1", "SG36" and "SG49"
2215 (both entries)	in column 16b, insert "SGG1", "SG36" and "SG49"
2216	in column 6, insert "973"
2217	in column 6, remove "117" and insert "973"
2218	in column 16b, insert "SGG1", "SG36" and "SG49"
2225	in column 16b, insert "SGG1"
2226	in column 16b, insert "SGG1", "SG36" and "SG49"
2234	in column 16b, insert "SGG10"
2238	in column 16b, insert "SGG10"
2240	in column 16b, insert "SGG1a", "SG36" and "SG49"
2248	in column 16b, insert "SG35"
2258	in column 16b, insert "SG35"
2259	in column 16b, insert "SGG18"
2260	in column 16b, insert "SG35"
2262	in column 16b, insert "SGG1", "SG36" and "SG49"
2264	in column 16b, insert "SG35"
2266	in column 16b, insert "SG35"
2267	in column 16b, insert "SGG1", "SG36" and "SG49"
2269	in column 16b, insert "SG35"
2270	in column 16b, insert "SGG18"
2276	in column 16b, insert "SG35"
2279	in column 16b, insert "SGG10"
2280 (both entries)	in column 16b, insert "SG35"
2289	in column 16b, insert "SG35"
2291	in column 16b, insert "SGG7" and "SGG9"
2305	in column 16b, insert "SGG1", "SG36" and "SG49"
2308	in column 16b, insert "SGG1a", "SG36" and "SG49"
2316	in column 16b, insert "SGG6"
2317	in column 16b, insert "SGG6"
2318	in column 16b, insert "SGG18"
2320	in column 16b, insert "SGG18"
2321	in column 16b, insert "SGG10"

2322	in column 16b, insert "SGG10"
2326	in column 16b, insert "SG35"
2327	in column 16b, insert "SG35"
2331	in column 16b, insert "SGG1", "SGG7", "SG36" and "SG49"
2334	in column 16b, insert "SG35"
2339	in column 16b, insert "SGG10"
2341	in column 16b, insert "SGG10"
2342	in column 16b, insert "SGG10"
2343	in column 16b, insert "SGG10"
2344 PG II	in column 16b, insert "SGG10"
2344 PG III	in column 16b, insert "SGG10"
2353	in column 16b, insert "SGG1", "SG36" and "SG49"
2356	in column 16b, insert "SGG10"
2357	in column 16b, insert "SG35"
2359	in column 16b, insert "SG35"
2361	in column 16b, insert "SG35"
2362	in column 16b, insert "SGG10"
2379	in column 16b, insert "SGG18"
2382	in column 16b, insert "SGG18"
2383	in column 16b, insert "SG35"
2386	in column 16b, insert "SGG18"
2387	in column 16b, insert "SGG10"
2388	in column 16b, insert "SGG10"
2390	in column 16b, insert "SGG10"
2391	in column 16b, insert "SGG10"
2392	in column 16b, insert "SGG10"
2395	in column 16b, insert "SGG1", "SG36" and "SG49"
2399	in column 16b, insert "SGG18"
2401	in column 16b, insert "SGG18"
2407	in column 16b, insert "SGG1", "SG36" and "SG49"
2426	in column 16b, insert "SGG2"
2427 PG II	in column 16b, insert "SGG4"
2427 PG III	in column 16b, insert "SGG4"
2428 PG II	in column 16b, insert "SGG4"
2428 PG III	in column 16b, insert "SGG4"
2429 PG II	in column 16b, insert "SGG4"
2429 PG III	in column 16b, insert "SGG4"
2434	in column 16b, insert "SGG1", "SG36" and "SG49"
2435	in column 16b, insert "SGG1", "SG36" and "SG49"
2437	in column 16b, insert "SGG1", "SG36" and "SG49"
2438	in column 16b, insert "SGG1", "SG36" and "SG49"
2439	in column 2, remove the hyphen to read "SODIUM HYDROGENDIFLUORIDE"; in column 16b, insert "SGG1", "SG36" and "SG49"

2440	in column 16b, insert "SGG1", "SG36" and "SG49"
2441	in column 16b, insert "SGG7"
2442	in column 16b, insert "SGG1", "SG36" and "SG49"
2443	in column 16b, insert "SGG1", "SG36" and "SG49"
2444	in column 16b, insert "SGG1", "SG36" and "SG49"
2456	in column 16b, insert "SGG10"
2466	in column 16b, insert "SGG16"
2469	in column 16b, insert "SGG3" and "SGG7"
2475	in column 16b, insert "SGG1", "SG36" and "SG49"
2491	in column 16b, insert "SGG18"
2495	in column 16b, insert "SGG1", "SG36" and "SG49"
2496	in column 16b, insert "SGG1", "SG36" and "SG49"
2502	in column 16b, insert "SGG1", "SG36" and "SG49"
2503	in column 16b, insert "SGG1", "SG36" and "SG49"
2504	in column 16b, insert "SGG10"
2505	in column 16b, insert "SGG2"
2506	in column 16b, insert "SGG1", "SGG2", "SG36" and "SG49"
2507	in column 16b, insert "SGG1", "SG36" and "SG49"
2508	in column 16b, insert "SGG1", "SG36" and "SG49"
2509	in column 16b, insert "SGG1", "SG36" and "SG49"
2511	in column 16b, insert "SGG1", "SG36" and "SG49"
2513	in column 16b, insert "SGG1", "SG49"
2515	in column 16b, insert "SGG10"
2526	in column 16b, insert "SG35"
2531	in column 16b, insert "SGG1", "SG36" and "SG49"
2545	in column 16b, insert "SGG15"
2546 PG I	in column 16b, insert "SGG7" and "SGG15"
2546 PG II	in column 16b, insert "SGG7" and "SGG15"
2546 PG III	in column 16b, insert "SGG7" and "SGG15"
2547	in column 16b, insert "SGG16"
2554	in column 16b, insert "SGG10"
2556	in column 16a, add "SW1" and "H2"
2564 PG II	in column 16b, insert "SGG1", "SG36" and "SG49"
2564 PG III	in column 16b, insert "SGG1", "SG36" and "SG49"
2565	in column 16b, insert "SG35"
2571	in column 16b, insert "SGG1", "SG36" and "SG49"
2573	in column 16b, insert "SGG4"
2576	in column 16b, insert "SGG1", "SG36" and "SG49"
2577	in column 16b, insert "SGG1", "SG36" and "SG49"
2578	in column 16b, insert "SGG1", "SG36" and "SG49"
2579	in column 16b, insert "SGG18"
2580	in column 16b, insert "SGG1", "SG36" and "SG49"
2581	in column 16b, insert "SGG1", "SG36" and "SG49"
2582	in column 16b, insert "SGG1", "SG36" and "SG49"
2583	in column 16b, insert "SGG1", "SG36" and "SG49"
2584	in column 16b, insert "SGG1", "SG36" and "SG49"
2585	in column 16b, insert "SGG1", "SG36" and "SG49"

2586	in column 16b, insert "SGG1", "SG36" and "SG49"
2604	in column 16b, insert "SGG1", "SG36" and "SG49"
2610	in column 16b, insert "SG35"
2619	in column 16b, insert "SG35"
2626	in column 16b, insert "SGG1" and "SG36"
2627	in column 16b, insert "SGG12"
2642	in column 16b, insert "SGG1", "SG36" and "SG49"
2644	in column 16b, insert "SGG10"
2646	in column 16b, insert "SGG10"
2664	in column 16b, insert "SGG10"
2670	in column 16b, insert "SGG1", "SG36" and "SG49"
2671	in column 16b, insert "SGG18"
2672	in column 16b, insert "SGG18"
2677 PG II	in column 16b, insert "SGG18"
2677 PG III	in column 16b, insert "SGG18"
2678	in column 16b, insert "SGG18"
2679 PG II	in column 16b, insert "SGG18"
2679 PG III	in column 16b, insert "SGG18"
2680	in column 16b, insert "SGG18"
2681 PG II	in column 16b, insert "SGG18"
2681 PG III	in column 16b, insert "SGG18"
2682	in column 16b, insert "SGG18"
2683	in column 16b, insert "SGG2" and "SGG18"
2684	in column 16b, insert "SG35"
2685	in column 16b, insert "SG35"
2686	in column 16b, insert "SG35"
2687	in column 16b, insert "SGG2"
2688	in column 16b, insert "SGG10"
2691	in column 16b, insert "SGG1" and "SG49"
2692	in column 16b, insert "SGG1", "SG36" and "SG49"
2698	in column 16b, insert "SGG1", "SG36" and "SG49"; in column 6, insert "973"
2699	in column 16b, insert "SGG1", "SG36" and "SG49"
2714	in column 16b, insert "SGG7"
2719	in column 16b, insert "SGG3"
2721	in column 16b, insert "SGG4"
2723	in column 16b, insert "SGG4"
2726	in column 16b, insert "SGG12"
2733 PG I	in column 16b, insert "SGG18"
2733 PG II	in column 16b, insert "SGG18"
2733 PG III	in column 16b, insert "SGG18"
2734 PG I	in column 16b, insert "SGG18"

2734 PG II	in column 16b, insert "SGG18"
2735 PG I	in column 16b, insert "SGG18"
2735 PG II	in column 16b, insert "SGG18"
2735 PG III	in column 16b, insert "SGG18"
2739	in column 16b, insert "SGG1", "SG36" and "SG49"
2740	in column 16b, insert "SGG1", "SG36" and "SG49"
2741	in column 16b, insert "SGG8"
2742	in column 16b, insert "SGG1", "SG36" and "SG49"
2743	in column 16b, insert "SGG1", "SG36" and "SG49"
2744	in column 16b, insert "SGG1", "SG36" and "SG49"
2745	in column 16b, insert "SGG1", "SG36" and "SG49"
2746	in column 16b, insert "SGG1", "SG36" and "SG49"
2748	in column 16b, insert "SGG1", "SG36" and "SG49"
2751	in column 16b, insert "SGG1", "SG36" and "SG49"
2777 PG I	in column 16b, insert "SGG7" and "SGG11"
2777 PG II	in column 16b, insert "SGG7" and "SGG11"
2777 PG III	in column 16b, insert "SGG7" and "SGG11"
2778 PG I	in column 16b, insert "SGG7" and "SGG11"
2778 PG II	in column 16b, insert "SGG7" and "SGG11"
2789	in column 16b, insert "SGG1", "SG36" and "SG49"
2790 PG II	in column 16b, insert "SGG1", "SG36" and "SG49"
2790 PG III	in column 16b, insert "SGG1", "SG36" and "SG49"
2794	in column 16b, insert "SGG1", "SG36" and "SG49"
2795	in column 16b, insert "SGG18"
2796	in column 16b, insert "SGG1a", "SG36" and "SG49"
2797	in column 16b, insert "SGG18"
2798	in column 16b, insert "SGG1", "SG36" and "SG49"
2799	in column 16b, insert "SGG1", "SG36" and "SG49"
2800	in column 6, delete "29"
2802	in column 16b, insert "SGG1", "SG36" and "SG49"
2809	in column 16b, insert "SGG7" and "SGG11"
2815	in column 16b, insert "SG35"
2817 PG II	in column 16b, insert "SGG1", "SGG2", "SG36" and "SG49"
2817 PG III	in column 16b, insert "SGG1", "SGG2", "SG36" and "SG49"
2818 PG II	in column 16b, insert "SGG2" and "SGG18"
2818 PG III	in column 16b, insert "SGG2" and "SGG18"
2819	in column 16b, insert "SGG1", "SG36" and "SG49"

2820	in column 16b, insert "SGG1", "SG36" and "SG49"
2823	in column 16b, insert "SGG1", "SG36" and "SG49"
2826	in column 16b, insert "SGG1", "SG36" and "SG49"
2829	in column 16b, insert "SGG1", "SG36" and "SG49"
2831	in column 16b, insert "SGG10"
2834	in column 16b, insert "SGG1", "SG36" and "SG49"
2841	in column 16b, insert "SG35"
2850	in column 17, at the end, add "1-dodecene is not marine pollutant."
2851	in column 16b, insert "SGG1", "SG36" and "SG49"
2854	in column 16b, insert "SGG2"
2855	in column 16b, insert "SGG7"
2859	in column 16b, insert "SGG2"
2861	in column 16b, insert "SGG2"
2863	in column 16b, insert "SGG2"
2865	in column 16b, insert "SGG1", "SG35", "SG36" and "SG49"
2869 PG II	in column 16b, insert "SGG1", "SGG7", "SG36" and "SG49"
2869 PG III	in column 16b, insert "SGG1", "SGG7", "SG36" and "SG49"
2872 PG II	in column 16b, insert "SGG10"
2872 PG III	in column 16b, insert "SGG10"
2878	in column 16b, insert "SGG7" and "SGG15"
2879	in column 16b, insert "SGG1", "SG36" and "SG49"
2880 PG II	in column 16b, insert "SGG8"
2880 PG III	in column 16b, insert "SGG8"
2881 PG I	in column 16b, insert "SGG7" and "SGG15"
2881 PG II	in column 16b, insert "SGG7" and "SGG15"
2881 PG III	in column 16b, insert "SGG7" and "SGG15"
2945	in column 16b, insert "SG35"
2949	in column 16b, insert "SGG18"
2950	in column 16b, insert "SGG15"
2967	in column 16b, insert "SGG1", "SG36" and "SG49"
2977	in column 16b, insert "SG17", "SG76" and "SG78"
2978	in column 16b, insert "SG17", "SG76" and "SG78"
2985	in column 16b, insert "SGG1", "SG36" and "SG49"
2986	in column 16b, insert "SGG1", "SG36" and "SG49"
2987	in column 16b, insert "SGG1", "SG36" and "SG49"
2988	in column 16b, insert "SGG1", "SG36" and "SG49"
2989 PG II	in column 16b, insert "SGG7" and "SGG9"
2989 PG III	in column 16b, insert "SGG7" and "SGG9"
3011 PG I	in column 16b, insert "SGG7" and "SGG11"

3011 PG II	in column 16b, insert "SGG7" and "SGG11"
3011 PG III	in column 16b, insert "SGG7" and "SGG11"
3012 PG I	in column 16b, insert "SGG7" and "SGG11"
3012 PG II	in column 16b, insert "SGG7" and "SGG11"
3012 PG III	in column 16b, insert "SGG7" and "SGG11"
3028	in column 16b, insert "SGG18"
3055	in column 16b, insert "SG35"
3073	in column 16b, insert "SGG18"
3078	in column 16b, insert "SGG15"
3089 PG II	in column 16b, insert "SGG7" and "SGG15"
3089 PG III	in column 16b, insert "SGG7" and "SGG15"
3090	in column 6, insert "387"; in column 8, insert "P911", "LP905" and "LP906"
3091	in column 6, insert "387"; in column 8, insert "P911", "LP905" and "LP906"
3101	in column 16b, insert "SG72"
3102	in column 16b, insert "SG72"
3103	in column 16b, insert "SG72"
3104	in column 16b, insert "SG72"
3106	in column 16b, insert "SG72"
3108	in column 16b, insert "SG72"
3110	in column 16b, insert "SG72"
3111	in column 16b, insert "SG72"
3112	in column 16b, insert "SG72"
3113	in column 16b, insert "SG72"
3114	in column 16b, insert "SG72"
3115	in column 16b, insert "SG72"
3116	in column 16b, insert "SG72"
3117	in column 16b, insert "SG72"
3118	in column 16b, insert "SG72"
3119	in column 16b, insert "SG72"
3120	in column 16b, insert "SG72"
3149	in column 16b, insert "SGG16"
3166	in column 6, delete "312", delete "380", delete "385" and insert "388"
3170 PG II	in column 16b, insert "SGG15"
3170 PG III	in column 16b, insert "SGG15"
3171	in column 6, delete "240" and insert "388"
3174	in column 16b, insert "SGG7"
3181 PG II	in column 16b, insert "SGG7"
3181 PG III	in column 16b, insert "SGG7"
3189 PG II	in column 16b, insert "SGG7" and "SGG15"

3189 PG III	in column 16b, insert "SGG7" and "SGG15"
3211 PGII	in column 16b, insert "SGG13"
3211 PGIII	in column 16b, insert "SGG13"
3212	in column 16b, insert "SGG8"
3213 PG II	in column 16b, insert "SGG3"
3213 PG III	in column 16b, insert "SGG3"
3214	in column 16b, insert "SGG14"
3219 PG II	in column 16b, insert "SGG12"
3219 PG III	in column 16b, insert "SGG12"
3223	in column 9, add "PP94 PP95"
3224	in column 9, add "PP94 PP95"
3246	in column 16b, insert "SGG1", "SG36" and "SG49"
3250	in column 16b, insert "SGG1", "SG36" and "SG49"
3253	in column 16b, insert "SGG18"
3255	in column 16b, insert "SGG8"
3259 PG I	in column 16b, insert "SGG18"
3259 PG II	in column 16b, insert "SGG18"
3259 PG III	in column 16b, insert "SGG18"
3260 PG I	in column 16b, insert "SGG1", "SG36" and "SG49"
3260 PG II	in column 16b, insert "SGG1", "SG36" and "SG49"
3260 PG III	in column 16b, insert "SGG1", "SG36" and "SG49"
3261 PG I	in column 16b, insert "SGG1", "SG36" and "SG49"
3261 PG II	in column 16b, insert "SGG1", "SG36" and "SG49"
3261 PG III	in column 16b, insert "SGG1", "SG36" and "SG49"
3262 PG I	in column 16b, insert "SGG18"
3262 PG II	in column 16b, insert "SGG18"
3262 PG III	in column 16b, insert "SGG18"
3263 PG I	in column 16b, insert "SGG18"
3263 PG II	in column 16b, insert "SGG18"
3263 PG III	in column 16b, insert "SGG18"

3264 PG I	in column 16b, insert "SGG1", "SG36" and "SG49"
3264 PG II	in column 16b, insert "SGG1", "SG36" and "SG49"
3264 PG III	in column 16b, insert "SGG1", "SG36" and "SG49"
3265 PG I	in column 16b, insert "SGG1", "SG36" and "SG49"
3265 PG II	in column 16b, insert "SGG1", "SG36" and "SG49"
3265 PG III	in column 16b, insert "SGG1", "SG36" and "SG49"
3266 PG I	in column 16b, insert "SGG18"
3266 PG II	in column 16b, insert "SGG18"
3266 PG III	in column 16b, insert "SGG18"
3267 PG I	in column 16b, insert "SGG18"
3267 PG II	in column 16b, insert "SGG18"
3267 PG III	in column 16b, insert "SGG18"
3277	in column 16b, insert "SGG1", "SG36" and "SG49"
3293	in column 16b, insert "SGG18"
3302	in column 2, at the end of the designation, add ", STABILIZED"; in column 6, add "386"
3316 PG II	in column 5, delete "II"
3316 PG III	delete this entire entry
3318	in column 16b, insert "SGG18"
3320 PG II	in column 16b, insert "SGG18"
3320 PG III	in column 16b, insert "SGG18"
3332	in column 15, replace "S-S" with " <u>S-S</u> "
3333	in column 15, replace "S-S" with " <u>S-S</u> "
3360	in column 6, insert "973"
3361	in column 16b, insert "SGG1", "SG36" and "SG49"
3362	in column 16b, insert "SGG1", "SG36" and "SG49"
3375	in column 16b, insert "SGG2"
3377	in column 16b, insert "SGG16"
3378 PG II	in column 16b, insert "SGG16"
3378 PG III	in column 16b, insert "SGG16"
3401	in column 16b, insert "SGG7" and "SGG11"
3402	in column 16b, insert "SGG7" and "SGG11"
3405 PG II	in column 16b, insert "SGG4"

3405 PG III	in column 16b, insert "SGG4"
3406 PG II	in column 16b, insert "SGG13"
3406 PG III	in column 16b, insert "SGG13"
3407 PG II	in column 16b, insert "SGG4"
3407 PG III	in column 16b, insert "SGG4"
3408 PG II	in column 16b, insert "SGG7", "SGG9" and "SGG13"
3408 PG III	in column 16b, insert "SGG7", "SGG9" and "SGG13"
3412 PG II	in column 16b, insert "SGG1", "SG36" and "SG49"
3412 PG III	in column 16b, insert "SGG1", "SG36" and "SG49"
3413 PG I	in column 16b, insert "SGG6"
3413 PG II	in column 16b, insert "SGG6"
3413 PG III	in column 16b, insert "SGG6"
3414 PG I	in column 16b, insert "SGG6"
3414 PG II	in column 16b, insert "SGG6"
3414 PG III	in column 16b, insert "SGG6"
3419	in column 16b, insert "SGG1", "SG36" and "SG49"
3420	in column 16b, insert "SGG1", "SG36" and "SG49"
3421 PG II	in column 16b, insert "SGG1", "SG36" and "SG49"
3421 PG III	in column 16b, insert "SGG1", "SG36" and "SG49"
3423	in column 16b, insert "SGG2" and "SGG18"
3424 PG II	in column 16b, insert "SGG2"
3424 PG III	in column 16b, insert "SGG2"
3425	in column 16b, insert "SGG1", "SG36" and "SG49"
3449	in column 16b, insert "SGG6"
3453	in column 16b, insert "SGG1", "SG36" and "SG49"
3456	in column 16b, insert "SGG1", "SG36" and "SG49"
3463	in column 16b, insert "SGG1", "SG36" and "SG49"
3472	in column 16b, insert "SGG1", "SG36" and "SG49"
3480	in column 6, insert "387"; in column 8, insert "P911", "LP905" and "LP906"
3481	in column 6, insert "387"; in column 8, insert "P911", "LP905" and "LP906"
3483	in column 16b, insert "SGG7" and "SGG9"
3484	in column 16b, insert "SGG18"
3485	in column 16b, insert "SGG8"
3486	in column 16b, insert "SGG8"

3487 PG II	in column 16b, insert "SGG8"
3487 PG III	in column 16b, insert "SGG8"
3496	in column 17, replace the sentence by "Nickel-metal hydride cells or batteries packed with or contained in equipment and nickel-metal hydride button are not subject to the provisions of this Code."
3498	in column 16b, insert "SGG1", "SG36" and "SG49"
3507	in column 16b, insert "SG77"

Add the following new entries to the Dangerous Goods List:

(1)	(2)	(3)	(4)	(5)	(6)	(7a)	(7b)	(8)	(9)	(10)	(11)	(12)	(13)	(14)	(15)	(16a)	(16b)	(17)
3535	TOXIC SOLID, FLAMMABLE, INORGANIC, N.O.S.	6.1	4.1	I	274	0	E5	P002	-	IBC99	-	-	T6	TP33	F-A, S-G	Category B	-	Toxic if swallowed, by skin contact or by dust inhalation.
3535	TOXIC SOLID, FLAMMABLE, INORGANIC, N.O.S.	6.1	4.1	II	274	500 g	E4	P002	-	IBC08	B4 B21	-	T3	TP33	F-A, S-G	Category B	-	See entry above.
3536	LITHIUM BATTERIES INSTALLED IN CARGO TRANSPORT UNIT lithium ion batteries or lithium metal batteries	9	-	-	389	0	E0	-	-	-	-	-	-	-	F-A, S-I	Category A	-	Cargo transport unit containing lithium metal or lithium ion batteries which is designed to serve as mobile power supply unit.
3537	ARTICLES CONTAINING FLAMMABLE GAS, N.O.S.	2.1	See 2.0.6.6	-	274 391	0	E0	P006 LP03	-	-	-	-	-	-	F-D, <u>S-U</u>	Category D SW2	-	-
3538	ARTICLES CONTAINING NON-FLAMMABLE, NON-TOXIC GAS, N.O.S.	2.2	See 2.0.6.6	-	274 391	0	E0	P006 LP03	-	-	-	-	-	-	F-C, <u>S-V</u>	Category A	-	-
3539	ARTICLES CONTAINING TOXIC GAS, N.O.S.	2.3	See 2.0.6.6	-	274 391	0	E0	-	-	-	-	-	-	-	F-C, <u>S-U</u>	-	-	-
3540	ARTICLES CONTAINING FLAMMABLE LIQUID, N.O.S.	3	See 2.0.6.6	-	274 391	0	E0	P006 LP03	-	-	-	-	-	-	F-E, <u>S-D</u>	Category B	-	-
3541	ARTICLES CONTAINING FLAMMABLE SOLID, N.O.S.	4.1	See 2.0.6.6	-	274 391	0	E0	P006 LP03	-	-	-	-	-	-	F-A, <u>S-G</u>	Category B	-	-
3542	ARTICLES CONTAINING A SUBSTANCE LIABLE TO SPONTANEOUS COMBUSTION, N.O.S.	4.2	See 2.0.6.6	-	274 391	0	E0	-	-	-	-	-	-	-	*	-	-	* F-G, <u>S-M</u> for pyrophoric substances, F-A, <u>S-J</u> for self-heating substances.
3543	ARTICLES CONTAINING A SUBSTANCE WHICH EMITS FLAMMABLE GAS IN CONTACT WITH WATER, N.O.S.	4.3	See 2.0.6.6	-	274 391	0	E0	-	-	-	-	-	-	-	F-G, <u>S-N</u>	-	-	-
3544	ARTICLES CONTAINING OXIDIZING SUBSTANCE, N.O.S.	5.1	See 2.0.6.6	-	274 391	0	E0	-	-	-	-	-	-	-	F-A, <u>S-Q</u>	-	-	-

MSC 99/22/Add.1
Annex 7, page 46

(1)	(2)	(3)	(4)	(5)	(6)	(7a)	(7b)	(8)	(9)	(10)	(11)	(12)	(13)	(14)	(15)	(16a)	(16b)	(17)
3545	ARTICLES CONTAINING ORGANIC PEROXIDE, N.O.S.	5.2	See 2.0.6.6	-	274 391	0	E0	-	-	-	-	-	-	-	F-J, <u>S-R</u>	-	-	-
3546	ARTICLES CONTAINING TOXIC SUBSTANCE, N.O.S.	6.1	See 2.0.6.6	-	274 391	0	E0	P006 LP03	-	-	-	-	-	-	F-A, <u>S-A</u>	Category B SW2 *	-	Toxic if swallowed, by skin contact or by dust inhalation. *When competent authority approval is required by SP391, the stowage and handling will be specified by the competent authority.
3547	ARTICLES CONTAINING CORROSIVE SUBSTANCE, N.O.S.	8	See 2.0.6.6	-	274 391	0	E0	P006 LP03	-	-	-	-	-	-	F-A, <u>S-B</u>	Category B SW2	-	Causes burns to skin, eyes and mucous membranes.
3548	ARTICLES CONTAINING MISCELLANEOUS DANGEROUS GOODS, N.O.S.	9	See 2.0.6.6	-	274 391	0	E0	P006 LP03	-	-	-	-	-	-	F-A, <u>S-P</u>	Category A	-	-

Chapter 3.3 Special provisions applicable to certain substances, materials or articles

3.3.1 In the third sentence, replace "such as "Damaged Lithium Batteries"" with "such as "LITHIUM BATTERIES FOR DISPOSAL"".

SP 29 Amend to read as follows:

"29 The packages, including bales, are exempt from labelling provided that they are marked with the appropriate class (e.g. "class 4.2")."

SP 63 In the introductory text, replace "risks" with "hazard(s)". In .5 replace "risk" with "hazard". In .7 replace "risk" with "hazard" and replace "risk(s)" with "hazard(s)".

SP 122 Replace "risk(s)" with "hazard(s)".

SP 133 Replace "risk" with "hazard".

SP 172 Replace "risk(s)" with "hazard(s)". In .1 and .2, replace "risk" with "hazard". In .3, replace "risk(s)" with "hazard(s)".

SP 181 Replace "risk" with "hazard".

SP 186 is deleted.

SP 188 In sub-paragraph .3, replace "2.9.4.1 and 2.9.4.5" with "2.9.4.1, 2.9.4.5, 2.9.4.6 if applicable and 2.9.4.7"

In sub-paragraph .4, replace "protection against contact with conductive materials" with "protection against contact with electrically conductive material". At the end of .4, replace "." with ";".

In sub-paragraph .5, at the end, add the following two new sentences:

"When packages are placed in an overpack, the lithium battery mark shall either be clearly visible or be reproduced on the outside of the overpack and the overpack shall be marked with the word "OVERPACK". The lettering of the "OVERPACK" mark shall be at least 12 mm high;"

In sub-paragraph .6, rename the existing note as note 1 and add the following new note 2:

Note 2: Packages containing lithium batteries packed in conformity with the provisions of part 4, chapter 11, packing instructions 965 or 968, Section IB of the ICAO Technical Instructions for the Safe Transport of Dangerous Goods by Air that bear the mark as shown in 5.2.1.10 (lithium battery mark) and the label shown in 5.2.2.2.2, Model No. 9A shall be deemed to meet the provisions of this special provision."

In the first paragraph after sub-paragraph .8, at the end, add the following sentence:

"As used in this special provision "equipment" means apparatus for which the lithium cells or batteries will provide electrical power for its operation."

SP 193 Amend to read as follows:

"193 This entry may only be used for ammonium nitrate based compound fertilizers. They shall be classified in accordance with the procedure as set out in the Manual of Tests and Criteria, part III, section 39. "

SP 204 Replace "risk" with "hazard" twice and add the word "hazard" between "subsidiary" and "label" in the last sentence.

SP 240 is deleted.

SP 251 In the first paragraph, replace the last sentence with:

"Such kits shall only contain dangerous goods that are permitted as:

- .1 excepted quantities not exceeding the quantity indicated by the Code in column 7b of the Dangerous Goods List of chapter 3.2, provided that the net quantity per inner packaging and net quantity per package are as prescribed in 3.5.1.2 and 3.5.1.3; or
- .2 limited quantities as indicated in column 7a of the Dangerous Goods List of chapter 3.2, provided that the net quantity per inner packaging does not exceed 250 ml or 250 g."

In the second paragraph, delete the last sentence.

In the third paragraph, insert a new first sentence to read as follows:

"For the purposes of completion of the dangerous goods transport document as set out in 5.4.1.4.1, the packing group shown on the document shall be the most stringent packing group assigned to any individual substance in the kit."

SP 271 Replace "risk" with "hazard".

SP 290 In sub-paragraph .2, replace "risk" with "hazard".

SP 293 In sub-paragraph .2, after "Safety matches are", insert "matches that".

SP 296 Replace "risk" with "hazard".

SP 301 At the beginning, replace "substance" with "goods". Amend the fifth and sixth sentences to read as follows:

"If the machinery or apparatus contains more than one item of dangerous goods, the individual dangerous goods shall be enclosed to prevent them reacting dangerously with one another during transport (see 4.1.1.6). When it is required to ensure liquid dangerous goods remain in their intended orientation, orientation arrows shall be displayed on at least two opposite vertical sides with the arrows pointing in the correct direction in accordance with 5.2.1.7.1."

Delete the last sentence.

SP 307 Amend to read as follows:

"307 This entry may only be used for ammonium nitrate based fertilizers. They shall be classified in accordance with the procedure as set out in the Manual of Tests and Criteria, part III, section 39."

SP 308 Amend to read as follows:

"308* Stabilization of fish meal shall be achieved to prevent spontaneous combustion by effective application of ethoxyquin, BHT (butylated hydroxytoluene) or tocopherols (also used in a blend with rosemary extract) at the time of production. The said application shall occur within twelve months prior to shipment. Fish scrap or fish meal shall contain at least 50 ppm (mg/kg) of ethoxyquin, 100 ppm (mg/kg) of BHT or 250 ppm (mg/kg) of tocopherol based antioxidant at the time of shipment."

and add a corresponding footnote * as follows:

"* For the transport of fish meal in bulk, see the IMSBC Code."

SP 310 In the first paragraph, replace "cells and batteries" with "cells or batteries", twice, and add "or LP905 of 4.1.4.3, as applicable" at the end.

SP 312 is deleted.

SP 362 In sub-paragraph .2 and .3, replace "risk" with "hazard".

SP 363 Add the following new introductory sentence:

"This entry may only be used when the conditions of this special provision are met. No other provisions of this Code apply, except for special provision 972, chapter 5.4, part 7 and columns 16a and 16b of the Dangerous Goods List."

Replace the existing sub-paragraph .7 with the following:

".7 The engine or machinery, including the means of containment containing dangerous goods, shall be in compliance with the construction requirements specified by the competent authority.

.8 Any valves or openings (e.g. venting devices) shall be closed during transport.

.9 The engines or machinery shall be oriented to prevent inadvertent leakage of dangerous goods and secured by means capable of restraining the engines or machinery to prevent any movement during transport which would change the orientation or cause them to be damaged.

.10 For UN 3528 and UN 3530:

- where the engine or machinery contains more than 60 L of liquid fuel and has a capacity of not more than 450 L, the labelling requirements of 5.2.2 shall apply;

- where the engine or machinery contains more than 60 L of liquid fuel and has a capacity of more than 450 L but not more than 3,000 L, it shall be labelled on two opposing sides in accordance with 5.2.2;
- where the engine or machinery contains more than 60 L of liquid fuel and has a capacity of more than 3,000 L, it shall be placarded on two opposing sides in accordance with 5.3.1.1.2; and
- in addition to the above requirements, for UN 3530, where the engine or machinery contains more than 60 L of liquid fuel and the capacity does not exceed 3,000 L, the marking requirements of 5.2.1.6 apply; and where the engine or machinery contains more than 60 L of liquid fuel and the capacity exceeds 3,000 L, the marking requirements of 5.3.2.3.2 apply.

.11 For UN 3529:

- where the fuel tank of the engine or machinery has a water capacity of not more than 450 L, the labelling requirements of 5.2.2 shall apply;
- where the fuel tank of the engine or machinery has a water capacity of more than 450 L but not more than 1,000 L, it shall be labelled on two opposing sides in accordance with 5.2.2; and
- where the fuel tank of the engine or machinery has a water capacity of more than 1,000 L, it shall be placarded on two opposing sides in accordance with 5.3.1.1.2.

.12 The transport document shall contain the following additional statement "Transport in accordance with special provision 363".

.13 The requirements specified in packing instruction P005 of 4.1.4.1 shall be met."

SP 369 In the first paragraph, replace "risks" with "hazards". In the third paragraph, replace "risk" with "hazard".

SP 376 Amend the text after the third paragraph to read as follows:

"Cells and batteries shall be packed in accordance with packing instructions P908 of 4.1.4.1 or LP904 of 4.1.4.3, as applicable.

Cells and batteries identified as damaged or defective and liable to rapidly disassemble, dangerously react, produce a flame or a dangerous evolution of heat or a dangerous emission of toxic, corrosive or flammable gases or vapours under normal conditions of transport shall be packed and transported in accordance with packing instruction P911 of 4.1.4.1 or LP906 of 4.1.4.3, as applicable. Alternative packing and/or transport conditions may be authorized by the competent authority.

Packages shall be marked "DAMAGED/DEFECTIVE" in addition to the proper shipping name, as stated in 5.2.1.

The transport document shall include the following statement "Transport in accordance with special provision 376".

If applicable, a copy of the competent authority approval shall accompany the transport."

SP 377 At the end, add a new paragraph as follows:

"The transport document shall include the following statement: "Transport in accordance with special provision 377"."

SP 380 is deleted.

SP 384 Delete the note.

SP 385 is deleted.

SP 907 Replace the terms "which must exceed 100 mg/kg" with "see special provision 308".

SP 943 Replace "subsidiary risk" with "subsidiary hazard".

SP 945 is deleted.

SP 959 Replace "subsidiary risk(s)" with "subsidiary hazard(s)".

SP 961 In sub-paragraph .1, replace "2.9.4.1 does" with "2.9.4.1 and 2.9.4.7 do".

SP 962 In sub-paragraph .4, replace "2.9.4.1 does" with "2.9.4.1 and 2.9.4.7 do".

SP 963 Replace the first sentence with the following:

"Nickel-metal hydride cells or batteries packed with or contained in equipment and nickel-metal hydride button cells are not subject to the provisions of this Code."

SP 972 Replace "2.9.4.1 does" with "2.9.4.1 and 2.9.4.7 do".

Add the following new special provisions:

"387 Lithium batteries in conformity with 2.9.4.6 containing both primary lithium metal cells and rechargeable lithium ion cells shall be assigned to UN 3090 or 3091 as appropriate. When such batteries are transported in accordance with special provision 188, the total lithium content of all lithium metal cells contained in the battery shall not exceed 1.5 g and the total capacity of all lithium ion cells contained in the battery shall not exceed 10 Wh."

"388 UN 3166 entries apply to vehicles powered by flammable liquid or gas internal combustion engines or fuel cells.

Vehicles powered by a fuel cell engine shall be assigned to the entries UN 3166 VEHICLE, FUEL CELL, FLAMMABLE GAS POWERED or UN 3166 VEHICLE, FUEL CELL, FLAMMABLE LIQUID POWERED, as appropriate. These entries include hybrid electric vehicles powered by both a fuel cell and an internal combustion engine with wet batteries, sodium batteries, lithium metal batteries or lithium ion batteries, transported with the battery(ies) installed.

Other vehicles which contain an internal combustion engine shall be assigned to the entries UN 3166 VEHICLE, FLAMMABLE GAS POWERED or UN 3166 VEHICLE, FLAMMABLE LIQUID POWERED, as appropriate. These entries include hybrid electric vehicles powered by both an internal combustion engine and wet batteries, sodium batteries, lithium metal batteries or lithium ion batteries, transported with the battery(ies) installed. If a vehicle is powered by a flammable liquid and a flammable gas internal combustion engine, it shall be assigned to UN 3166 VEHICLE, FLAMMABLE GAS POWERED.

Entry UN 3171 only applies to vehicles powered by wet batteries, sodium batteries, lithium metal batteries or lithium ion batteries and equipment powered by wet batteries or sodium batteries transported with these batteries installed.

For the purpose of this special provision, vehicles are self-propelled apparatus designed to carry one or more persons or goods. Examples of such vehicles are cars, motorcycles, scooters, three- and four-wheeled vehicles or motorcycles, trucks, locomotives, bicycles (pedal cycles with a motor) and other vehicles of this type (e.g. self-balancing vehicles or vehicles not equipped with at least one seating position), wheelchairs, lawn tractors, self-propelled farming and construction equipment, boats and aircraft. This includes vehicles transported in a packaging. In this case some parts of the vehicle may be detached from its frame to fit into the packaging.

Examples of equipment are lawnmowers, cleaning machines or model boats and model aircraft. Equipment powered by lithium metal batteries or lithium ion batteries shall be assigned to the entries UN 3091 LITHIUM METAL BATTERIES CONTAINED IN EQUIPMENT or UN 3091 LITHIUM METAL BATTERIES PACKED WITH EQUIPMENT or UN 3481 LITHIUM ION BATTERIES CONTAINED IN EQUIPMENT or UN 3481 LITHIUM ION BATTERIES PACKED WITH EQUIPMENT, as appropriate.

Dangerous goods, such as batteries, airbags, fire extinguishers, compressed gas accumulators, safety devices and other integral components of the vehicle that are necessary for the operation of the vehicle or for the safety of its operator or passengers, shall be securely installed in the vehicle and are not otherwise subject to this Code."

- "389 This entry only applies to lithium ion batteries or lithium metal batteries installed in a cargo transport unit and designed only to provide power external to the cargo transport unit. The lithium batteries shall meet the requirements of 2.9.4.1 to .7 and contain the necessary systems to prevent overcharge and overdischarge between the batteries.

The batteries shall be securely attached to the interior structure of the cargo transport unit (e.g. by means of placement in racks, cabinets, etc.) in such a manner as to prevent short circuits, accidental operation, and significant movement relative to the cargo transport unit under the shocks, loadings and vibrations normally incident to transport. Dangerous goods necessary for the safe and proper operation of the cargo transport unit (e.g. fire-extinguishing systems and air-conditioning systems), shall be properly secured to or installed in the cargo transport unit and are not otherwise subject to this Code.

Dangerous goods not necessary for the safe and proper operation of the cargo transport unit shall not be transported within the cargo transport unit.

The batteries inside the cargo transport unit are not subject to marking or labelling requirements. The cargo transport unit shall display the UN number in accordance with 5.3.2.1.2 and be placarded on two opposing sides in accordance with 5.3.1.1.2."

"391 Articles containing dangerous goods of class 2.3, or class 4.2, or class 4.3, or class 5.1, or class 5.2 or class 6.1 for substances of inhalation toxicity requiring packing group I and articles containing more than one of the hazards listed in 2.0.3.4.2 to 2.0.3.4.4 shall be transported under conditions approved by the competent authority."

"392 For the transport of fuel gas containment systems designed and approved to be fitted in motor vehicles containing this gas, the provisions of subsection 4.1.4.1 and chapter 6.2 of this Code need not be applied when transported for disposal, recycling, repair, inspection, maintenance or from where they are manufactured to a vehicle assembly plant, provided the following conditions are met:

- .1 the fuel gas containment systems shall meet the requirements of the standards or regulations for fuel tanks for vehicles, as applicable. Examples of applicable standards and regulations are:

LPG tanks	
ECE Regulation No. 67 Revision 2	Uniform provisions concerning: I. Approval of specific equipment of vehicles of category M and N using liquefied petroleum gases in their propulsion system; II. Approval of vehicles of category M and N fitted with specific equipment for the use of liquefied petroleum gases in their propulsion system with regard to the installation of such equipment
ECE Regulation No. 115	Uniform provisions concerning the approval of: I. Specific LPG (liquefied petroleum gases) retrofit systems to be installed in motor vehicles for the use of LPG in their propulsion systems; II. Specific CNG (compressed natural gas) retrofit systems to be installed in motor vehicles for the use of CNG in their propulsion system
CNG tanks	
ECE Regulation No. 110	Uniform provisions concerning: I. Specific components of motor vehicles using compressed natural gas (CNG) and/or liquefied natural gas (LNG) in their propulsion system; II. Vehicles with regard to the installation of specific components of an approved type for the use of compressed natural gas (CNG) and/or liquefied natural gas (LNG) in their propulsion system
ECE Regulation No. 115	(Uniform provisions concerning the approval of I. Specific LPG (liquefied petroleum gases) retrofit systems to be installed in motor vehicles for the use of LPG in their propulsion systems; II. Specific CNG (compressed natural gas) retrofit systems to be installed in motor vehicles for the use of CNG in their propulsion system)

ISO 11439:2013	Gas cylinders – High pressure cylinders for the onboard storage of natural gas as a fuel for automotive vehicles
ISO 15500-Series	ISO 15500: Road vehicles – Compressed natural gas (CNG) fuel system components – several parts as applicable
ANSI NGV 2	Compressed natural gas vehicle fuel containers
CSA B51 Part 2: 2014	Boiler, pressure vessel, and pressure piping code Part 2 Requirements for high-pressure cylinders for onboard storage of fuels for automotive vehicles
Hydrogen pressure tanks	
Global Technical Regulation (GTR) No. 13	Global technical regulation on hydrogen and fuel cell vehicles (ECE/TRANS/180/Add.13)
ISO/TS 15869:2009	Gaseous hydrogen and hydrogen blends – Land vehicle fuel tanks
Regulation (EC) No.79/2009	Regulation (EC) No. 79/2009 of the European Parliament and of the Council of 14 January 2009 on type approval of hydrogen-powered motor vehicles, and amending Directive 2007/46/EC
Regulation (EU) No. 406/2010	Commission Regulation (EU) No. 406/2010 of 26 April 2010 implementing Regulation (EC) No. 79/2009 of the European Parliament and of the Council on type-approval of hydrogen-powered motor vehicles
ECE Regulation No. 134	Hydrogen and fuel cell vehicles (HFCV)
CSA B51 Part 2: 2014	Boiler, pressure vessel, and pressure piping code Part 2 Requirements for high-pressure cylinders for onboard storage of fuels for automotive vehicles

Gas tanks designed and constructed in accordance with previous versions of relevant standards or regulations for gas tanks for motor vehicles, which were applicable at the time of the certification of the vehicles for which the gas tanks were designed and constructed may continue to be transported;

- .2 the fuel gas containment systems shall be leakproof and shall not exhibit any signs of external damage which may affect their safety;

Note 1: Criteria may be found in standard ISO 11623:2015 *Transportable gas cylinders – Periodic inspection and testing of composite gas cylinders* (or ISO 19078:2013 *Gas cylinders – Inspection of the cylinder installation, and requalification of high pressure cylinders for the onboard storage of natural gas as a fuel for automotive vehicles*).

Note 2: If the fuel gas containment systems are not leakproof or are overfilled or if they exhibit damage that could affect their safety (e.g. in case of a safety-related recall), they shall only be carried in salvage pressure receptacles in conformity with this Code.

- .3 if a fuel gas containment system is equipped with two valves or more integrated in line, the two valves shall be closed as to be gastight under normal conditions of transport. If only one valve exists or only one valve works, all openings with the exception of the opening of

the pressure relief device shall be closed as to be gastight under normal conditions of transport;

- .4 fuel gas containment systems shall be transported in such a way as to prevent obstruction of the pressure relief device or any damage to the valves and any other pressurised part of the fuel gas containment systems and unintentional release of the gas under normal conditions of transport. The fuel gas containment system shall be secured in order to prevent slipping, rolling or vertical movement;
- .5 valves shall be protected by one of the methods described in 4.1.6.1.8.1 to 4.1.6.1.8.5;
- .6 except for the case of fuel gas containment systems removed for disposal, recycling, repair, inspection or maintenance, they shall be filled with not more than 20% of their nominal filling ratio or nominal working pressure, as applicable;
- .7 notwithstanding the provisions of chapter 5.2, when fuel gas containment systems are consigned in a handling device, markings and labels may be affixed to the handling device; and
- .8 notwithstanding the provisions of 5.4.1.5, the information on the total quantity of dangerous goods may be replaced by the following information:
 - .1 the number of fuel gas containment systems; and
 - .2 in the case of liquefied gases the total net mass (kg) of gas of each fuel gas containment system and, in the case of compressed gases, the total water capacity (l) of each fuel gas containment system followed by the nominal working pressure.

Examples for information in the transport document:

Example 1: "UN 1971 natural gas, compressed, 2.1, 1 fuel gas containment system of 50 l in total, 200 bar".

Example 2: "UN 1965 hydrocarbon gas mixture, liquefied, n.o.s., 2.1, 3 fuel gas containment systems, each of 15 kg net mass of gas".

"973 Packages, with the exception of bales, shall also display the proper shipping name and the UN number of the substance that they contain in accordance with 5.2.1. In any case, the packages, including bales, are exempt from class marking provided that they are loaded in a cargo transport unit and that they contain goods to which only one UN number has been assigned. The cargo transport units in which the packages, including bales, are loaded shall display any relevant labels, placards and marks in accordance with chapter 5.3."

"974 These substances may be transported in IMO type 9 tanks."

Chapter 3.4
Dangerous goods packed in limited quantities

3.4.6 Documentation

3.4.6.1 Replace the words "dangerous goods declaration" with "dangerous goods transport document".

Chapter 3.5
Dangerous goods packed in excepted quantities

3.5.6 Documentation

3.5.6.1 Replace the words "dangerous goods declaration" with "dangerous goods transport document".

PART 4
PACKING AND TANK PROVISIONS

Chapter 4.1
Use of packagings, including intermediate bulk containers (IBCs)
and large packagings

4.1.4 List of packing instructions

4.1.4.1 Packing instructions concerning the use of packagings (except IBCs and large packagings)

P001 Under "Composite packagings", in the first line, replace "Plastics receptacle in steel or aluminium drum (6HA1, 6HB1)" with "Plastics receptacle in steel, aluminium or plastics drum (6HA1, 6HB1, 6HH1)". In the second line, replace "Plastics receptacle in fibre, plastics or plywood drum (6HG1, 6HH1, 6HD1)" with "Plastics receptacle in fibre or plywood drum (6HG1, 6HD1)".

P101 Replace "The State's distinguishing sign for motor vehicles in international traffic" with "The distinguishing sign used on vehicles in international road traffic*".

Table note * reads as follows:

"* Distinguishing sign of the State of registration used on motor vehicles and trailers in international road traffic, e.g. in accordance with the Geneva Convention on Road Traffic of 1949 or the Vienna Convention on Road Traffic of 1968."

P200 In paragraph (3) (e), in the first paragraph, replace "liquid phase" with "liquefied gas". In sub-paragraph (i), replace "liquid component" with "liquefied gas". In sub-paragraph (iv), replace "liquid component" with "liquefied gas". In sub-paragraph (v), replace "liquid component" with "liquefied gas". In the last paragraph, replace "liquid component" with "liquid phase". In the header of column 4 of tables 1, 2 and 3, replace "risk" with "hazard".

P203 In paragraph (7), replace "risk" with "hazard".

P206 In paragraph (3), in the first paragraph, replace "liquid phase" with "liquefied gas". In sub-paragraph (a), replace "liquid component" with "liquefied gas". In sub-paragraph (d), replace "liquid component" with "liquefied gas". In sub-paragraph (e), replace "liquid component" with "liquefied gas". In the last paragraph, replace "liquid component" with "liquid phase".

P208 In the header of column 4 of table 1, replace "risk" with "hazard".

P403 In special packing provisions PP31, delete ", except for solid fused material".

P410 Replace the table note (4) with the following:

"For packing group II substances, these packagings may only be used when transported in a closed cargo transport unit."

P520 In additional provision 4, replace "risk" with "hazard". Furthermore, add the following new special packing provisions PP94 and PP95:

"PP94 Very small amounts of energetic samples of section 2.0.4.3 may be carried under UN 3223 or UN 3224, as appropriate, provided that:

- .1 only combination packaging with outer packaging comprising boxes (4A, 4B, 4N, 4C1, 4C2, 4D, 4F, 4G, 4H1 and 4H2) are used;
- .2 the samples are carried in microtiter plates or multi-titer plates made of plastics, glass, porcelain or stoneware as inner packaging;
- .3 the maximum amount per individual inner cavity does not exceed 0.01 g for solids or 0.01 ml for liquids;
- .4 the maximum net quantity per outer packaging is 20 g for solids or 20 ml for liquids, or in the case of mixed packing the sum of grams and millilitres does not exceed 20; and
- .5 when dry ice or liquid nitrogen is optionally used as a coolant for quality control measures, the requirements of 5.5.3 are complied with. Interior supports shall be provided to secure the inner packagings in their original position. The inner and outer packagings shall maintain their integrity at the temperature of the refrigerant used as well as the temperatures and the pressures which could result if refrigeration were lost.

PP95 Small amounts of energetic samples of section 2.0.4.3 may be carried under UN 3223 or UN 3224, as appropriate, provided that:

- .1 the outer packaging consist only of corrugated fibreboard of type 4G having minimum dimensions of 60 cm (length) by 40.5 cm (width) by 30 cm (height) and minimum wall thickness of 1.3 cm;
- .2 the individual substance is contained in an inner packaging of glass or plastics of maximum capacity 30 ml placed in an expandable polyethylene foam matrix of at least 130 mm thickness having a density of 18 ± 1 g/l;
- .3 within the foam carrier, inner packagings are segregated from each other by a minimum distance of 40 mm and from the wall of the outer packaging by a

- minimum distance of 70 mm. The package may contain up to two layers of such foam matrices, each carrying up to 28 inner packagings;
- .4 the maximum content of each inner packaging does not exceed 1 g for solids or 1 ml for liquids;
 - .5 the maximum net quantity per outer packaging is 56 g for solids or 56 ml for liquids, or in the case of mixed packing the sum of grams and millilitres does not exceed 56; and
 - .6 when dry ice or liquid nitrogen is optionally used as a coolant for quality control measures, the requirements of 5.5.3 are complied with. Interior supports shall be provided to secure the inner packagings in their original position. The inner and outer packagings shall maintain their integrity at the temperature of the refrigerant used as well as the temperatures and the pressures which could result if refrigeration were lost."

P620 In additional provision 3, at the end, delete "and temperatures in the range -40°C to +55°C" and add the following new sentence: "This primary receptacle or secondary packaging shall also be capable of withstanding temperatures in the range -40°C to +55°C."

P801 In additional provision 2, replace "non-conductive" with "electrically non-conductive".

P901 Under "Additional requirement", delete "not exceed either 250 ml or 250 g and shall".

P902 In the paragraph under "Unpackaged articles:", amend the end of the sentence to read "when moved to, from, or between where they are manufactured and an assembly plant including intermediate handling locations."

P903 Before the introductory sentence that starts with "The following packagings...", insert a new sentence to read "For the purpose of this packing instruction, "equipment" means apparatus for which the lithium cells or batteries will provide electrical power for its operation.". In paragraph (3), delete the last sentence.

P906 In paragraph (2), in the introductory sentence and in sub-paragraph (b), replace "devices" with "articles" three times.

P907 At the beginning, add a new box with the following sentence:

"This instruction applies to UN 3363."

P908 In paragraphs (2) and (4), replace "non-conductive" with "electrically non-conductive".

P909 In paragraphs (1)(c) and (2)(b), in the fourth indent of additional requirement 2 and in additional requirement 3, replace "non-conductive" with "electrically non-conductive".

P910 In the introductory sentence, replace "cells and batteries" with "cells or batteries" twice.

In paragraphs (1)(c), (1)(d), (2)(c), and fourth indent of the additional requirements, replace "non-conductive" with "electrically non-conductive".

Insert the following new packing instructions:

P006	PACKING INSTRUCTION	P006
This instruction applies to UN Nos. 3537, 3538, 3540, 3541, 3546, 3547 and 3548.		
<p>(1) The following packagings are authorized, provided that the general provisions of 4.1.1 and 4.1.3 are met: drums (1A2, 1B2, 1N2, 1H2, 1D, 1G); boxes (4A, 4B, 4N, 4C1, 4C2, 4D, 4F, 4G, 4H1, 4H2); and jerricans (3A2, 3B2, 3H2). Packagings shall conform to the packing group II performance level.</p> <p>(2) In addition, for robust articles the following packagings are authorized: Strong outer packagings constructed of suitable material and of adequate strength and design in relation to the packaging capacity and its intended use. The packagings shall meet the provisions of 4.1.1.1, 4.1.1.2, 4.1.1.8 and 4.1.3 in order to achieve a level of protection that is at least equivalent to that provided by chapter 6.1. Articles may be transported unpackaged or on pallets when the dangerous goods are afforded equivalent protection by the article in which they are contained.</p> <p>(3) Additionally, the following conditions shall be met:</p> <ul style="list-style-type: none"> (a) receptacles within articles containing liquids or solids shall be constructed of suitable materials and secured in the article in such a way that, under normal conditions of transport, they cannot break, be punctured or leak their contents into the article itself or the outer packaging; (b) receptacles containing liquids with closures shall be packed with their closures correctly oriented. The receptacles shall in addition conform to the internal pressure test provisions of 6.1.5.5; (c) receptacles that are liable to break or be punctured easily, such as those made of glass, porcelain or stoneware or of certain plastic materials, shall be properly secured. Any leakage of the contents shall not substantially impair the protective properties of the article or of the outer packaging; (d) receptacles within articles containing gases shall meet the requirements of section 4.1.6 and chapter 6.2 as appropriate or be capable of providing an equivalent level of protection to packing instructions P200 or P208; and (e) where there is no receptacle within the article, the article shall fully enclose the dangerous substances and prevent their release under normal conditions of transport. <p>(4) Articles shall be packed to prevent movement and inadvertent operation during normal conditions of transport.</p>		

P911	PACKING INSTRUCTION	P911
This instruction applies to damaged or defective cells and batteries of UN Nos. 3090, 3091, 3480 and 3481 liable to rapidly disassemble, dangerously react, produce a flame or a dangerous evolution of heat or a dangerous emission of toxic, corrosive or flammable gases or vapours under normal conditions of transport.		
<p>The following packagings are authorized, provided that the general provisions of 4.1.1 and 4.1.3 are met:</p> <p>For cells and batteries and equipment containing cells and batteries:</p> <ul style="list-style-type: none"> drums (1A2, 1B2, 1N2, 1H2, 1D, 1G); boxes (4A, 4B, 4N, 4C1, 4C2, 4D, 4F, 4G, 4H1, 4H2); and jerricans (3A2, 3B2, 3H2). <p>The packagings shall conform to the packing group I performance level.</p>		

P911	PACKING INSTRUCTION	P911
	<p>(1) The packaging shall be capable of meeting the following additional performance requirements in case of rapid disassembly, dangerous reaction, production of a flame or a dangerous evolution of heat or a dangerous emission of toxic, corrosive or flammable gases or vapours of the cells or batteries:</p> <ul style="list-style-type: none"> (a) the outside surface temperature of the completed package shall not have a temperature of more than 100°C. A momentary spike in temperature up to 200°C is acceptable; (b) no flame shall occur outside the package; (c) no projectiles shall exit the package; (d) the structural integrity of the package shall be maintained; and (e) the packagings shall have a gas management system (e.g. filter system, air circulation, containment for gas, gas tight packaging, etc.), as appropriate. <p>(2) The additional packaging performance requirements shall be verified by a test as specified by the competent authority.^a</p> <p>A verification report shall be available on request. As a minimum requirement, the cell or battery name, the cell or battery number, the mass, type, energy content of the cells or batteries, the packaging identification and the test data according to the verification method as specified by the competent authority shall be listed in the verification report.</p> <p>(3) When dry ice or liquid nitrogen is used as a coolant, the requirements of section 5.5.3 shall apply. The inner packaging and outer packaging shall maintain their integrity at the temperature of the refrigerant used as well as the temperatures and the pressures which could result if refrigeration were lost.</p>	
	<p>Additional requirement:</p> <p>Cells or batteries shall be protected against short circuit.</p>	
	<p>^a <i>The following criteria, as relevant, may be considered to assess the performance of the packaging:</i></p> <ul style="list-style-type: none"> <i>(a) the assessment shall be done under a quality management system (as described, e.g. in section 2.9.4.5) allowing for the traceability of tests results, reference data and characterization models used;</i> <i>(b) the list of hazards expected in case of thermal runaway for the cell or battery type, in the condition it is transported (e.g. usage of an inner packaging, state of charge (SOC), use of sufficient non-combustible, electrically non-conductive and absorbent cushioning material, etc.), shall be clearly identified and quantified; the reference list of possible hazards for lithium cells or batteries (rapidly disassemble, dangerously react, produce a flame or a dangerous evolution of heat or a dangerous emission of toxic, corrosive or flammable gases or vapours) can be used for this purpose. The quantification of these hazards shall rely on available scientific literature;</i> <i>(c) the mitigating effects of the packaging shall be identified and characterized, based on the nature of the protections provided and the construction material properties. A list of technical characteristics and drawings shall be used to support this assessment (Density [$\text{kg}\cdot\text{m}^{-3}$], specific heat capacity [$\text{J}\cdot\text{kg}^{-1}\cdot\text{K}^{-1}$], heating value [$\text{kJ}\cdot\text{kg}^{-1}$], thermal conductivity [$\text{W}\cdot\text{m}^{-1}\cdot\text{K}^{-1}$], melting temperature and flammability temperature [K], heat transfer coefficient of the outer packaging [$\text{W}\cdot\text{m}^{-2}\cdot\text{K}^{-1}$], ...);</i> <i>(d) the test and any supporting calculations shall assess the result of a thermal runaway of the cell or battery inside the packaging in the normal conditions of transport;</i> <i>(e) in case the SOC of the cell or battery is not known, the assessment used shall be done with the highest possible SOC corresponding to the cell or battery use conditions;</i> 	

P911	PACKING INSTRUCTION	P911
<p>(f) the surrounding conditions in which the packaging may be used and transported shall be described (including for possible consequences of gas or smoke emissions on the environment, such as ventilation or other methods) according to the gas management system of the packaging;</p> <p>(g) the tests or the model calculation shall consider the worst case scenario for the thermal runaway triggering and propagation inside the cell or battery: this scenario includes the worst possible failure in the normal transport condition, the maximum heat and flame emissions for the possible propagation of the reaction; and</p> <p>(h) these scenarios shall be assessed over a period long enough to allow all the possible consequences to occur (e.g. 24 hours).</p>		

4.1.4.2 Packing instructions concerning the use of IBCs

IBC 08 In the special packing provisions of B21, add a new substance of UN 3535 in the first sentence, to read "For substances, UN Nos. 1374, 2590 and 3535 in IBCs other than..."

IBC520 In the third line, after "4.1.7.2 are met.", insert a new sentence to read as follows:

"The formulations listed below may also be transported packed in accordance with packing method OP8 of packing instruction P520 of 4.1.4.1, with the same control and emergency temperatures, if applicable."

For UN 3109, in the entry "tert-Butyl hydroperoxide, not more than 72% with water", add a new line under the column "Type of IBC" and "quantity" to read:

"31HA1" "1000"

Add the following new entries to packing instruction IBC520:

UN No.	Organic peroxide	Type of IBC	Maximum quantity (litres)	Control temperature	Emergency Temperature
3109	2,5-Dimethyl-2,5-di(tert-butylperoxy)hexane, not more than 52% in diluent type A	31HA1	1000		
3109	3,6,9-Triethyl-3,6,9-trimethyl-1,4,7-triperoxonane, not more than 27% in diluent type A	31HA1	1000		
3119	tert-Amyl peroxy-2-ethylhexanoate, not more than 62% in diluent type A	31HA1	1000	+15°C	+20°C

4.1.4.3 Packing instructions concerning the use of large packagings

LP902 Under "Packaged articles", replace "Packagings conforming to the packing group III performance level." with:

"Rigid large packagings conforming to the packing group III performance level, made of:

steel (50A);
aluminium (50B);
metal other than steel or aluminium (50N);
rigid plastics (50H);
natural wood (50C);
plywood (50D);
reconstituted wood (50F); and
rigid fibreboard (50G)."

In the paragraph under "Unpackaged articles:", amend the end of the sentence to read "when moved to, from or between where they are manufactured and an assembly plant including intermediate handling locations."

LP903 Replace the second sentence with the following:

"The following large packagings are authorized for a single battery and for a single item of equipment containing cells or batteries, provided that the general provisions of 4.1.1 and 4.1.3 are met:"

LP904 Replace the first sentence with the following:

"This instruction applies to single damaged or defective batteries and to single items of equipment containing damaged or defective cells or batteries of UN Nos. 3090, 3091, 3480 and 3481."

Replace the second sentence with the following:

"The following large packagings are authorized for a single damaged or defective battery and for a single item of equipment containing damaged or defective cells or batteries, provided the general provisions of 4.1.1 and 4.1.3 are met."

In the third sentence, replace "containing batteries" with "containing cells and batteries". Before "steel (50A)", insert the following new line: "Rigid large packagings conforming to the packing group II performance level, made of:". After "plywood (50D)", delete "Packagings shall conform to the packing group II performance level."

Amend the beginning of the first sentence of paragraph .1 to read as follows:

"The damaged or defective battery or equipment containing such cells or batteries shall be ...".

In .2, amend the beginning of the sentence to read "The inner packaging". Replace "non-conductive" with "electrically non-conductive".

In .4, after "movement of the battery" add "or the equipment". Replace "non-conductive" with "electrically non-conductive". In the last sentence, after "For leaking batteries", add "and cells,"

In the additional requirement, after "Batteries", add "and cells".

Insert the following new packing instructions:

LP03	PACKING INSTRUCTION	LP03
This instruction applies to UN Nos. 3537, 3538, 3540, 3541, 3546, 3547 and 3548.		
<p>(1) The following large packagings are authorized, provided that the general provisions of 4.1.1 and 4.1.3 are met:</p> <p>Rigid large packagings conforming to the packing group II performance level, made of:</p> <ul style="list-style-type: none"> steel (50A); aluminium (50B); metal other than steel or aluminium (50N); rigid plastics (50H); natural wood (50C); plywood (50D); reconstituted wood (50F); and rigid fibreboard (50G). <p>(2) Additionally, the following conditions shall be met:</p> <ul style="list-style-type: none"> (a) receptacles within articles containing liquids or solids shall be constructed of suitable materials and secured in the article in such a way that, under normal conditions of transport, they cannot break, be punctured or leak their contents into the article itself or the outer packaging; (b) receptacles containing liquids with closures shall be packed with their closures correctly oriented. The receptacles shall in addition conform to the internal pressure test provisions of 6.1.5.5; (c) receptacles that are liable to break or be punctured easily, such as those made of glass, porcelain or stoneware or of certain plastics materials shall be properly secured. Any leakage of the contents shall not substantially impair the protective properties of the article or of the outer packaging; (d) receptacles within articles containing gases shall meet the requirements of section 4.1.6 and chapter 6.2 as appropriate or be capable of providing an equivalent level of protection as packing instructions P200 or P208; and (e) where there is no receptacle within the article, the article shall fully enclose the dangerous substances and prevent their release under normal conditions of transport. <p>(3) Articles shall be packed to prevent movement and inadvertent operation during normal conditions of transport.</p>		

LP905	PACKING INSTRUCTION	LP905
This instruction applies to UN Nos. 3090, 3091, 3480 and 3481 production runs consisting of not more than 100 cells and batteries and to pre-production prototypes of cells and batteries when these prototypes are transported for testing.		
The following large packagings are authorized for a single battery and for a single item of equipment containing cells or batteries, provided that the general provisions of 4.1.1 and 4.1.3 are met:		
<p>(1) For a single battery:</p> <p>rigid large packagings conforming to the packing group II performance level, made of:</p> <ul style="list-style-type: none"> steel (50A); aluminium (50B); 		

metal other than steel or aluminium (50N);
rigid plastics (50H);
natural wood (50C);
plywood (50D);
reconstituted wood (50F); and
rigid fibreboard (50G).

Large packagings shall also meet the following requirements:

- (a) a battery of different size, shape or mass may be packed in an outer packaging of a tested design type listed above provided the total gross mass of the package does not exceed the gross mass for which the design type has been tested;
 - (b) the battery shall be packed in an inner packaging and placed inside the outer packaging;
 - (c) the inner packaging shall be completely surrounded by sufficient non-combustible and electrically non-conductive thermal insulation material to protect against a dangerous evolution of heat;
 - (d) appropriate measures shall be taken to minimize the effects of vibration and shocks and prevent movement of the battery within the package that may lead to damage and a dangerous condition during transport. When cushioning material is used to meet this requirement it shall be non-combustible and electrically non-conductive; and
 - (e) non-combustibility shall be assessed according to a standard recognized in the country where the large packaging is designed or manufactured.
- (2) For a single item of equipment:
rigid large packagings conforming to the packing group II performance level, made of:
steel (50A);
aluminium (50B);
metal other than steel or aluminium (50N);
rigid plastics (50H);
natural wood (50C);
plywood (50D);
reconstituted wood (50F); and
rigid fibreboard (50G).

Large packagings shall also meet the following requirements:

- (a) a single item of equipment of different size, shape or mass may be packed in an outer packaging of a tested design type listed above provided the total gross mass of the package does not exceed the gross mass for which the design type has been tested;
- (b) the equipment shall be constructed or packed in such a manner as to prevent accidental operation during transport;
- (c) appropriate measures shall be taken to minimize the effects of vibration and shocks and prevent movement of the equipment within the package that may lead to damage and a dangerous condition during transport. When cushioning material is used to meet this requirement, it shall be non-combustible and electrically non-conductive; and
- (d) non-combustibility shall be assessed according to a standard recognized in the country where the large packaging is designed or manufactured.

Additional requirement:

Cells and batteries shall be protected against short circuit.

LP906	PACKING INSTRUCTION	LP906
<p>This instruction applies to damaged or defective batteries of UN Nos. 3090, 3091, 3480 and 3481 liable to rapidly disassemble, dangerously react, produce a flame or a dangerous evolution of heat or a dangerous emission of toxic, corrosive or flammable gases or vapours under normal conditions of transport.</p>		
<p>The following large packagings are authorized, provided that the general provisions of 4.1.1 and 4.1.3 are met:</p>		
<p>For a single battery and for a single item of equipment containing cells or batteries: Rigid large packagings conforming to the packing group I performance level, made of:</p>		
<ul style="list-style-type: none"> steel (50A); aluminium (50B); metal other than steel or aluminium (50N); rigid plastics (50H); plywood (50D); and rigid fibreboard (50G). 		
<p>(1) The large packaging shall be capable of meeting the following additional performance requirements in case of rapid disassembly, dangerous reaction, production of a flame or a dangerous evolution of heat or a dangerous emission of toxic, corrosive or flammable gases or vapours of the battery:</p> <ul style="list-style-type: none"> (a) the outside surface temperature of the completed package shall not have a temperature of more than 100 °C. A momentary spike in temperature up to 200°C is acceptable; (b) no flame shall occur outside the package; (c) no projectiles shall exit the package; (d) the structural integrity of the package shall be maintained; and (e) the large packagings shall have a gas management system (e.g. filter system, air circulation, containment for gas, gas tight packaging etc.), as appropriate. <p>(2) The additional large packaging performance requirements shall be verified by a test as specified by the competent authority.^a</p> <p>A verification report shall be available on request. As a minimum requirement, the battery name, the battery number, the mass, type, energy content of the batteries, the large packaging identification and the test data according to the verification method as specified by the competent authority shall be listed in the verification report.</p> <p>(3) When dry ice or liquid nitrogen is used as a coolant, the requirements of section 5.5.3 shall apply. The inner packaging and outer packaging shall maintain their integrity at the temperature of the refrigerant used as well as the temperatures and the pressures which could result if refrigeration were lost.</p>		
<p>Additional requirement:</p>		
<p>Batteries shall be protected against short circuit.</p>		
<p>^a <i>The following criteria, as relevant, may be considered to assess the performance of the large packaging:</i></p>		
<p>(a) <i>the assessment shall be done under a quality management system (as described e.g. in section 2.9.4.5) allowing for the traceability of tests results, reference data and characterization models used;</i></p>		
<p>(b) <i>the list of hazards expected in case of thermal runaway for the battery type, in the condition it is transported (e.g. usage of an inner packaging, state of charge (SOC), use of sufficient non-combustible, electrically non-conductive and absorbent cushioning material etc.), shall be clearly identified and quantified; the reference list of possible hazards for lithium batteries</i></p>		

LP906	PACKING INSTRUCTION	LP906
<i>(rapidly disassemble, dangerously react, produce a flame or a dangerous evolution of heat or a dangerous emission of toxic, corrosive or flammable gases or vapours) can be used for this purpose. The quantification of these hazards shall rely on available scientific literature;</i>		
<i>(c) the mitigating effects of the large packaging shall be identified and characterized, based on the nature of the protections provided and the construction material properties. A list of technical characteristics and drawings shall be used to support this assessment (Density [kg m^3], specific heat capacity [$\text{J}\cdot\text{kg}^{-1}\cdot\text{K}^{-1}$], heating value [$\text{kJ}\cdot\text{kg}^{-1}$], thermal conductivity [$\text{W}\cdot\text{m}^{-1}\cdot\text{K}^{-1}$], melting temperature and flammability temperature [K], heat transfer coefficient of the outer packaging [$\text{W}\cdot\text{m}^{-2}\cdot\text{K}^{-1}$], ...);</i>		
<i>(d) the test and any supporting calculations shall assess the result of a thermal run-away of the battery inside the large packaging in the normal conditions of transport;</i>		
<i>(e) in case the SOC of the battery is not known, the assessment used shall be done with the highest possible SOC corresponding to the battery use conditions;</i>		
<i>(f) the surrounding conditions in which the large packaging may be used and transported shall be described (including for possible consequences of gas or smoke emissions on the environment, such as ventilation or other methods) according to the gas management system of the large packaging;</i>		
<i>(g) the tests or the model calculation shall consider the worst case scenario for the thermal runaway triggering and propagation inside the battery: this scenario includes the worst possible failure in the normal transport condition, the maximum heat and flame emissions for the possible propagation of the reaction; and</i>		
<i>(h) these scenarios shall be assessed over a period long enough to allow all the possible consequences to occur (e.g. 24 hours).</i>		

4.1.6 Special packing provisions for goods of class 2

4.1.6.1.4 In the third sentence, replace "risk" with "hazard".

4.1.9 Special packing provisions for radioactive material

4.1.9.1 General

4.1.9.1.5 Replace "risk" with "hazard" twice.

Chapter 4.2

Use of portable tanks and multiple-element gas containers (MEGCs)

4.2.0 Transitional provisions

4.2.0.1 In the note, after the definition for IMO type 8 tank, insert IMO type 9 tank definition as follows:

"IMO type 9 tank means a road gas elements vehicle for the transport of compressed gases of class 2 with elements linked to each other by a manifold, permanently attached to a chassis, which is fitted with items of service equipment and structural equipment necessary for the transport of gases. Elements are cylinders, tubes and bundles of cylinders, intended for the transport of gases as defined in 2.2.1.1."

4.2.1 General provisions for the use of portable tanks for the transport of substances of class 1 and classes 3 to 9

4.2.1.19 Additional provisions applicable to the transport of solid substances transported above their melting point

4.2.1.19.1 Replace "risk" with "hazard".

4.2.5.2 Portable tank instructions

T23 In the first box, at the end, add a new sentence to read as follows:

"The formulations listed below may also be transported packed in accordance with packing method OP8 of packing instruction P520 of 4.1.4.1, with the same control and emergency temperatures, if applicable."

In footnote [§], replace "risk" with "hazard".

4.2.5.3 Portable tank special provisions

TP10 Add the following new sentence at the end:

"A portable tank may be offered for transport after the date of expiry of the last lining inspection for a period not to exceed three months beyond the date of expiry of the last testing, after emptying but before cleaning, for purposes of performing the next required test or inspection prior to refilling."

4.2.6 Amend title of 4.2.6 to read "Additional provisions for the use of road tank vehicles and road gas elements vehicles"

4.2.6.1 Replace paragraph 4.2.6.1 with the following:

"4.2.6.1 The tank of a road tank vehicle or the elements of a road gas elements vehicle shall be attached to the vehicle during normal operations of filling, discharge and transport. IMO type 4 tanks shall be attached to the chassis when transported on board ships. Road tank vehicles and road gas elements vehicles shall not be filled or discharged while they remain on board. A road tank vehicle or road gas elements vehicle shall be driven on board on its own wheels and be fitted with permanent tie-down attachments for securing on board the ship."

4.2.6.2 Replace the words "Road tank vehicles shall comply" with "Road tank vehicles and road gas elements vehicles shall comply" and add the following new paragraph:

"4.2.6.3 Substances permitted to be transported in IMO type 9 tanks are assigned special provision 974."

PART 5 CONSIGNMENT PROCEDURES

Chapter 5.1 General provisions

5.1.1 Application and general provisions

At the end, add the following note:

Note: In accordance with the GHS, a GHS pictogram not required by this Code should only appear in transport as part of a complete GHS label and not independently (see GHS 1.4.10.4.4)."

5.1.4 Mixed packing

Replace "risk" with "hazard" twice.

5.1.5 General provisions for class 7

5.1.5.4.2 Replace the existing paragraph with the following:

"5.1.5.4.2 The documentation requirements of 5.4.1 and 5.4.5 do not apply to excepted packages of radioactive material of class 7, except that:

- .1 the UN number preceded by the letters "UN" and the name and address of the consignor and the consignee and, if relevant, the identification mark for each competent authority certificate of approval (see 5.4.1.5.7.1.7.) shall be shown on a special transport document such as a bill of lading, air waybill or other similar document complying with the requirements of 5.4.1.2.1 to 5.4.1.2.4; and
- .2 the requirements of 5.4.1.6.2 and, if relevant, those of 5.4.1.5.7.1.7, 5.4.1.5.7.3 and 5.4.1.5.7.4 shall apply."

Chapter 5.2 Marking and labelling of packages including IBCs

5.2.1 Marking of packages including IBCs

5.2.1.3 After "Salvage packagings", add "including large salvage packagings".

5.2.1.7.1 Replace the first four lines with the following:

"Except as provided in 5.2.1.7.2:

- combination packagings having inner packagings containing liquid dangerous goods;
- single packagings fitted with vents;
- cryogenic receptacles intended for the transport of refrigerated liquefied gases; and

- machinery or apparatus containing liquid dangerous goods when it is required to ensure the liquid dangerous goods remain in their intended orientation (see special provision 301 of chapter 3.3),"

5.2.2 Labelling of packages including IBCs

- 5.2.2.1.1 Replace "risks" with "hazards" and "risk" with "hazard".
- 5.2.2.1.2 Replace "risk" with "hazard" 6 times.
- 5.2.2.1.2.1 Delete the entry of "Batteries, wet, non-spillable 2800 8 Class 8⁺" and the corresponding footnote.
- 5.2.2.1.3 Replace "risk" with "hazard" 3 times.
- 5.2.2.1.3.1 Replace "risk" with "hazard" twice.
- 5.2.2.1.4 Replace "risk(s)" with "hazard(s)" 2 times and "risk" with "hazard" twice.
- 5.2.2.1.5 Replace "risks" with "hazards".
- 5.2.2.1.6.3 Replace "risk" with "hazard".
- 5.2.2.1.9 Replace "risk" with "hazard".
- 5.2.2.1.10 Replace "risk" with "hazard" four times.
- 5.2.2.1.11 Replace "risk" with "hazard".
- 5.2.2.1.13 Add a new subsection 5.2.2.1.13 as follows:
 - "5.2.2.1.13 Labels for articles containing dangerous goods transported as UN Nos. 3537, 3538, 3539, 3540, 3541, 3542, 3543, 3544, 3545, 3546, 3547 and 3548
 - .1 Packages containing articles or articles transported unpackaged shall bear labels according to 5.2.2.1.2 reflecting the hazards established according to 2.0.6. If the article contains one or more lithium battery with, for lithium metal batteries, an aggregate lithium content of 2 g or less, and for lithium ion batteries, a Watt-hour rating of 100Wh or less, the lithium battery mark (5.2.1.10.2) shall be affixed to the package or unpackaged article. If the article contains one or more lithium batteries with, for lithium metal batteries, an aggregate lithium content of more than 2 g and for lithium ion batteries, a Watt-hour rating of more than 100Wh, the lithium battery label (5.2.2.2.2 No. 9A) shall be affixed to the package or unpackaged article.
 - .2 When it is required to ensure articles containing liquid dangerous goods remain in their intended orientation, orientation marks meeting 5.2.1.7.1 shall be affixed and visible on at least two opposite vertical sides of the package or of the unpackaged article where possible, with the arrows pointing in the correct upright direction."

5.2.2.2 Provisions for labels

5.2.2.2.1.1.2 Replace the first three sentences with the following:

"The label shall be in the form of a square set at an angle of 45 degrees (diamond-shaped). The minimum dimensions shall be 100 mm x 100 mm. There shall be a line inside the edge forming the diamond which shall be parallel and approximately 5 mm from the outside of that line to the edge of the label."

5.2.2.2.1.1.3 In the first sentence, after "the dimensions may be reduced," add "proportionally". Delete the second and third sentences ("The line inside the edge shall remain 5 mm to the edge of the label. The minimum width of the line inside the edge shall remain 2 mm.").





5.2.2.2.1.2 In the first sentence, insert "*Gas cylinders – Precautionary labels*" after "ISO 7225:2005" and delete it in the second sentence.



5.2.2.2.1.5 Replace "risk" with "hazard".





5.2.2.2.2 Replace existing 5.2.2.2.2 with the following:

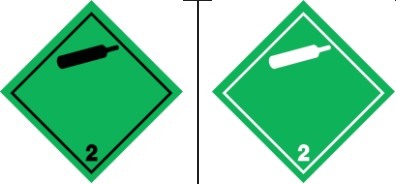



"5.2.2.2.2 Specimen labels





Note: Labels shall satisfy the provisions below and conform, in terms of colour, symbols and general format, to the models shown in 5.2.2.2.2. Corresponding models required for other modes of transport, with minor variations which do not affect the obvious meaning of the label, are also acceptable.



Label model No.	Class, Division or Category	Symbol and symbol colour	Background	Figure in bottom corner (and figure colour)	Specimen labels	Note
Class 1: Explosive substances or articles						
1	Divisions 1.1, 1.2, 1.3	Exploding bomb: black	Orange	1 (black)		** Place for division – to be left blank if explosive is the subsidiary hazard * Place for compatibility group – to be left blank if explosive is the subsidiary hazard
1.4	Division 1.4	1.4: black Numerals shall be about 30 mm in height and be about 5 mm thick (for a label measuring 100 mm x 100 mm)	Orange	1 (black)		* Place for compatibility group
1.5	Division 1.5	1.5: black Numerals shall be about 30 mm in height and be about 5 mm thick (for a label measuring 100 mm x 100 mm)	Orange	1 (black)		* Place for compatibility group
1.6	Division 1.6	1.6: black Numerals shall be about 30 mm in height and be about 5 mm thick (for a label measuring 100 mm x 100 mm)	Orange	1 (black)		* Place for compatibility group

Label model No.	Class, Division or Category	Symbol and symbol colour	Background	Figure in bottom corner (and figure colour)	Specimen labels	Note
Class 2: Gases						
2.1	Class 2.1: Flammable gases (except as provided for in 5.2.2.2.1.6.4)	Flame: black or white	Red	2 (black or white)		-
2.2	Class 2.2: Non-flammable, non-toxic gases	Gas cylinder: black or white	Green	2 (black or white)		-
2.3	Class 2.3: Toxic gases	Skull and crossbones: black	White	2 (black)		-

Label model No.	Class, Division or Category	Symbol and symbol colour	Background	Figure in bottom corner (and figure colour)	Specimen labels	Note
Class 3: Flammable liquids						
3	-	Flame: black or white	Red	3 (black or white)		-
Class 4: Flammable solids; substances liable to spontaneous combustion; substances which, in contact with water, emit flammable gases						
4.1	Class 4.1: Flammable solids, self-reactive substances, solid desensitized explosives and polymerizing substances	Flame: black	White with 7 vertical red stripes	4 (black)		-
4.2	Class 4.2: Substances liable to spontaneous combustion	Flame: black	Upper half white, lower half red	4 (black)		-
4.3	Class 4.3: Substances which, in contact with water emit flammable gases	Flame: black or white	Blue	4 (black or white)		-

Label model No.	Class, Division or Category	Symbol and symbol colour	Background	Figure in bottom corner (and figure colour)	Specimen labels	Note
Class 5: Oxidizing substances and organic peroxides						
5.1	Class 5.1: Oxidizing substances	Flame over circle: black	Yellow	5.1 (black)		-
5.2	Class 5.2: Organic peroxides	Flame: black or white	Upper half red, lower half yellow	5.2 (black)		-
Class 6: Toxic substances and infectious substances						
6.1	Class 6.1: Toxic substances	Skull and crossbones: black	White	6 (black)		-
6.2	Class 6.2: Infectious substances	Three crescents superimposed on a circle: black	White	6 (black)		The lower half of the label may bear the inscriptions: "INFECTIOUS SUBSTANCE" and "In the case of damage or leakage immediately notify Public Health Authority" in black colour

Label model No.	Class, Division or Category	Symbol and symbol colour	Background	Figure in bottom corner (and figure colour)	Specimen labels	Note
Class 7: Radioactive material						
7A	Category I	Trefoil: black	White	7 (black)		Text (mandatory), black in lower half of label: "RADIOACTIVE" "CONTENTS ..." "ACTIVITY ..." One red vertical bar shall follow the word: "RADIOACTIVE"
7B	Category II	Trefoil: black	Upper half yellow with white border, lower half white	7 (black)		Text (mandatory), black in lower half of label: "RADIOACTIVE" "CONTENTS ..." "ACTIVITY ..." In a black outlined box: "TRANSPORT INDEX"; Two red vertical bars shall follow the word: "RADIOACTIVE"
7C	Category III	Trefoil: black	Upper half yellow with white border, lower half white	7 (black)		Text (mandatory), black in lower half of label: "RADIOACTIVE" "CONTENTS ..." "ACTIVITY ..." In a black outlined box: "TRANSPORT INDEX". Three red vertical bars shall follow the word: "RADIOACTIVE"
7E	Fissile material	-	White	7 (black)		Text (mandatory): black in upper half of label: "FISSILE"; In a black outlined box in the lower half of label: "CRITICALITY SAFETY INDEX"

Label model No.	Class, Division or Category	Symbol and symbol colour	Background	Figure in bottom corner (and figure colour)	Specimen labels	Note
Class 8: Corrosive substances						
8	-	Liquids, spilling from two glass vessels and attacking a hand and a metal: black	Upper half white, lower half black with white border	8 (white)		-
Class 9: Miscellaneous dangerous substances and articles, including environmentally hazardous substances						
9	-	7 vertical stripes in upper half: black	White	9 underlined (black)		-
9A	-	7 vertical stripes in upper half: black; battery group, one broken and emitting flame in lower half: black	White	9 underlined (black)		-

11

Chapter 5.3 Placarding and marking of cargo transport units

Amend the title of chapter 5.3 to read "Placarding and marking of cargo transport units and bulk containers".

5.3.1 Placarding

5.3.1.1.1 Replace sub-paragraphs .1 to .3 with the following:

- .1 Enlarged labels (placards) and marks and signs shall be affixed to the exterior surfaces of a cargo transport unit or bulk container to provide a warning that the contents of the unit or bulk container are dangerous goods and present hazards, unless the labels and/or marks affixed to the packages are clearly visible from the exterior of the cargo transport unit or bulk container.
- .2 The methods of placarding and marking as required in 5.3.1.1.4 and 5.3.2 on cargo transport units and bulk containers shall be such that this information will still be identifiable on cargo transport units and bulk containers surviving at least three months' immersion in the sea. In considering suitable marking methods, account shall be taken of the ease with which the surface of the cargo transport unit or bulk container can be marked.
- .3 All placards, orange panels, marks and signs shall be removed from cargo transport units and bulk containers or masked as soon as both the dangerous goods or their residues which led to the application of those placards, orange panels, marks or signs are discharged."

5.3.1.1.2 In the first sentence, replace "risks" with "hazards" and after "transport units" add "and bulk containers". In the second sentence, replace "risk" with "hazard" and after "transport unit" add "and bulk container". In sub-paragraph .2, replace "risk" with "hazard".

5.3.1.1.3 In the first sentence, replace "risks" with "hazards" and "risk" with "hazard". In the second sentence, replace "risk" with "hazard" twice, and after "transport units" add "and bulk containers".

5.3.1.1.4.1 Replace paragraph 5.3.1.1.4.1 with the following:

"5.3.1.1.4.1 A cargo transport unit or bulk container containing dangerous goods or residues of dangerous goods shall clearly display placards as follows:

- .1 *a freight container, semi-trailer, a closed or sheeted bulk container or portable tank*: one on each side and one on each end of the unit. Portable tanks having a capacity of not more than 3,000 L may be placarded or, alternatively, may be labelled instead, on only two opposite sides;
- .2 *a railway wagon*: at least on each side;
- .3 *a multiple-compartment tank containing more than one dangerous substance or their residues*: along each side at the positions of the relevant compartments. If all compartments are required to display the same placards, these placards need to be displayed only once along each side of the cargo transport unit;

- .4 *a flexible bulk container*: in at least two opposing positions; and
- .5 *any other cargo transport unit*: at least on both sides and on the back of the unit."

5.3.1.2.1 At the end, delete the note.

5.3.2 Marking of cargo transport units

Amend the title of chapter 5.3.2 to read "Marking".

5.3.2.3.1 After "transport units", add "or bulk containers".

5.3.2.3.2 After "cargo transport units", add "and bulk containers".

Chapter 5.4 Documentation

5.4.1 Dangerous goods transport information

5.4.1.4 Information required on the dangerous goods transport document

5.4.1.4.1.4 Replace "risk" with "hazard".

5.4.1.5 Information required in addition to the dangerous goods description

5.4.1.5.3 In the heading and the following sentence, after "salvage packagings", add "including large salvage packagings".

5.4.1.5.5 Replace the paragraph as follows:

"For self-reactive substances, organic peroxides and polymerizing substances which require temperature control during transport, the control and emergency temperatures (see 7.3.7.2) shall be indicated on the dangerous goods transport document, as follows:

"Control temperature: ... °C Emergency temperature: ... °C". "

5.4.1.5.5.1 Replace "risk" with "hazard".

5.4.1.5.9 Explosives

5.4.1.5.9.1 Replace "distinguishing sign for motor vehicles in international traffic" with "distinguishing sign used on vehicles in international road traffic*", and add the corresponding footnote * to read as follows:

"* Distinguishing sign of the State of registration used on motor vehicles and trailers in international road traffic, e.g. in accordance with the Geneva Convention on Road Traffic of 1949 or the Vienna Convention on Road Traffic of 1968.",

5.4.1.5.9.2 Replace "distinguishing sign for motor vehicles in international traffic" with "distinguishing sign used on vehicles in international road traffic*", and add the corresponding footnote * to read as follows:

- "* Distinguishing sign of the State of registration used on motor vehicles and trailers in international road traffic, e.g. in accordance with the Geneva Convention on Road Traffic of 1949 or the Vienna Convention on Road Traffic of 1968.",

5.4.1.5.9.3 Replace "distinguishing sign for motor vehicles in international traffic" with "distinguishing sign used on vehicles in international road traffic*", and add the corresponding footnote * to read as follows:

- "* Distinguishing sign of the State of registration used on motor vehicles and trailers in international road traffic, e.g. in accordance with the Geneva Convention on Road Traffic of 1949 or the Vienna Convention on Road Traffic of 1968.",

5.4.1.5.15 In the second paragraph, replace "the distinguishing sign for motor vehicles in international traffic" with "the distinguishing sign used on vehicles in international road traffic*", with footnote * reading as follows:

- "* Distinguishing sign of the State of registration used on motor vehicles and trailers in international road traffic, e.g. in accordance with the Geneva Convention on Road Traffic of 1949 or the Vienna Convention on Road Traffic of 1968.",

and renumber subsequent footnotes accordingly.

5.4.3 Documentation required aboard the ship

Replace the provisions of 5.4.3 with the following:

"5.4.3 Documentation required aboard the ship

- 5.4.3.1 Each ship carrying dangerous goods and marine pollutants shall have a special list, manifest⁵ or stowage plan setting out, in accordance with regulation VII/ 4.2 of SOLAS, as amended, and with regulation 4.2 of Annex III of MARPOL, the dangerous goods (except dangerous goods in excepted packages of class 7) and marine pollutants and the location thereof. This special list or manifest shall be based on the documentation and certification required in this Code. It shall contain in addition to the information in 5.4.1.4, 5.4.1.5 and, for UN 3359, in 5.5.2.4.1.1, the stowage location and the total quantity of dangerous goods and marine pollutants. A detailed stowage plan, which identifies by class and sets out the location of all dangerous goods and marine pollutants, may be used in place of such special list or manifest.
- 5.4.3.2 Each ship carrying excepted packages of class 7 shall have a special list, manifest or stowage plan setting out these excepted packages and the location thereof. This special list or manifest shall be based upon the documents listed in 5.1.5.4.2.1.
- 5.4.3.3 A copy of the documents according to 5.4.3.1 and, if applicable, 5.4.3.2 shall be made available before departure to the person or organization designated by the port State authority.",

and add the corresponding footnote as follows:

- "⁵ Refer to Amendments to the Annex to the Convention on Facilitation of International Maritime Traffic, 1965 (resolution FAL.10(35), adopted on 16 January 2009)."

The existing 5.4.3.2 is renumbered to 5.4.3.4 and the existing 5.4.3.2.1 is renumbered to 5.4.3.4.1.

5.4.3.2.1.3 Add the word "*Revised*" before the words "*Emergency Response Procedures for Ships Carrying Dangerous Goods (EmS Guide)*".

5.4.5 Multimodal Dangerous Goods Form

5.4.5.1 Replace the existing text under 5.4.5.1 as follows:

"5.4.5.1 This form meets the requirements of SOLAS, chapter VII, regulation 4, MARPOL, Annex III, regulation 4 and the provisions of this chapter. The information required by the provisions of this chapter is mandatory; however, the layout of this form is not mandatory.

This form may be used as a combined dangerous goods transport document and container packing certificate for multimodal carriage of dangerous goods."

and delete the existing text under the title of "MULTIMODAL DANGEROUS GOODS FORM".

In the section for "Documentary Aspects of the International Transport of Dangerous Goods Container/Vehicle Packing Certificate", replace the existing sentence:

"If the consignments include goods of class 1, other than division 1.4, the container is structurally serviceable."

with the following:

"If the consignments include goods of class 1, other than division 1.4, the container/vehicle is structurally serviceable.";

replace the existing sentence:

"When solid carbon dioxide (CO₂ – dry ice) is used for cooling purposes, the vehicle or freight container is externally marked in accordance with 5.5.3.6."

with the following:

"When substances presenting a risk of asphyxiation are used for cooling or conditioning purposes (such as dry ice (UN 1845) or nitrogen, refrigerated liquid (UN 1977) or argon, refrigerated liquid (UN 1951)), the container/vehicle is externally marked in accordance with 5.5.3.6"; and

replace the existing sentence:

"When this Dangerous Goods Form is used as a container/vehicle packing certificate only, not a combined document, a dangerous goods Declaration signed by the shipper or supplier must have been issued/received to cover each dangerous goods consignment packed in the container."

with the following:

"When this Dangerous Goods Form is used as a container/vehicle packing certificate only, not a combined document, a dangerous goods Declaration signed by the shipper or supplier must have been issued/received to cover each dangerous goods consignment packed in the container/vehicle."

In the note, replace "The container" with "The container/vehicle".

Chapter 5.5 Special provisions

5.5.2 Special provisions applicable to fumigated cargo transport units (UN 3359)

Add a footnote "*" at the end of the heading, as follows:

- * *Refer to the Revised Recommendations on the safe use of pesticides in ships applicable to the fumigation of cargo transport units (MSC.1/Circ.1361)*

5.5.2.5 Additional provisions

Delete the paragraph 5.5.2.5.1 and renumber the remaining paragraphs accordingly.

PART 6 CONSTRUCTION AND TESTING OF PACKAGINGS, INTERMEDIATE BULK CONTAINERS (IBCs), LARGE PACKAGINGS, PORTABLE TANKS, MULTIPLE-ELEMENT GAS CONTAINERS (MEGCs) AND ROAD TANK VEHICLES

Chapter 6.1 Provisions for the construction and testing of packagings (other than for class 6.2 substances)

In the heading of the chapter, delete "(other than for class 6.2 substances)".

6.1.1 Applicability and general provisions

6.1.1.1 Applicability

6.1.1.1.2 (i) Replace "(subsidiary risks)" with "(subsidiary hazards)" and add a new sub-paragraph .5 to read as follows:

- ".5 Packagings for class 6.2 infectious substances of Category A."

6.1.3 Marking

6.1.3.1 (f) Replace the words "indicated by the distinguishing sign for motor vehicles in international traffic" with "indicated by the distinguishing sign used on vehicles in international road traffic".

6.1.3.8 (h) Replace the words "indicated by the distinguishing sign for motor vehicles in international traffic" with "indicated by the distinguishing sign used on vehicles in international road traffic*", and add the corresponding footnote * to read as follows:

* Distinguishing sign of the State of registration used on motor vehicles and trailers in international road traffic, e.g. in accordance with the Geneva Convention on Road Traffic of 1949 or the Vienna Convention on Road Traffic of 1968."

6.1.5.7 Test report

6.1.5.7.1 Under sub-paragraph .8, add the following sentence at the end:

"For plastics packagings subject to the internal pressure test in 6.1.5.5, the temperature of the water used."

Chapter 6.2

Provisions for the construction and testing of pressure receptacles, aerosol dispensers, small receptacles containing gas (gas cartridges) and fuel cell cartridges containing liquefied flammable gas

6.2.1 General provisions

6.2.1.6 Periodic inspection and test

6.2.1.6.1.4 Replace the existing note 2 with the following:

Note 2: For seamless steel cylinders and tubes the check of 6.2.1.6.1.2 and hydraulic pressure test of 6.2.1.6.1.4 may be replaced by a procedure conforming to ISO 16148:2016 *Gas cylinders – Refillable seamless steel gas cylinders and tubes – Acoustic emission examination (AT) and follow-up ultrasonic examination (UT) for periodic inspection and testing*

In note 3, replace the words "The hydraulic pressure test may be replaced" with "The check of 6.2.1.6.1.2 and the hydraulic pressure test of 6.2.1.6.1.4 may be replaced".

6.2.2 Provisions for UN pressure receptacles

6.2.2.1 Design, construction and initial inspection and test

6.2.2.1.1 In the table, for "ISO 11118:1999", in the column "Applicable for manufacture", replace "Until further notice" with "Until 31 December 2020".

In the table, after "ISO 11118:1999", insert a new line to read as follows:

ISO 11118:2015	Gas cylinders – Non-refillable metallic gas cylinders – Specification and test methods	Until further notice
----------------	--	----------------------

6.2.2.1.2 In the table, for "ISO 11120:1999", in the column "Applicable for manufacture", replace "Until further notice" with "Until 31 December 2022".

In the table, after "ISO 11120:1999", insert a new line to read as follows:

ISO 11120:2015	Gas cylinders – Refillable seamless steel tubes of water capacity between 150 l and 3 000 l – Design, construction and testing	Until further notice
----------------	--	----------------------

Insert a new paragraph 6.2.2.1.8 to read as follows:

"6.2.2.1.8 The following standards apply for the design, construction and initial inspection and test of UN pressure drums, except that inspection requirements related to the conformity assessment system and approval shall be in accordance with 6.2.2.5:

Reference	Title	Applicable for Manufacture
ISO 21172-1:2015	Gas cylinders – Welded steel pressure drums up to 3,000 litres capacity for the transport of gases – Design and construction – Part 1: Capacities up to 1,000 litres <i>NOTE: Irrespective of section 6.3.3.4 of this standard, welded steel gas pressure drums with dished ends convex to pressure may be used for the transport of corrosive substances provided all applicable requirements of this Code are met.</i>	Until further notice
ISO 4706: 2008	Gas cylinders – Refillable welded steel cylinders – Test pressure 60 bar and below	Until further notice
ISO 18172-1:2007	Gas cylinders – Refillable welded stainless steel cylinders – Part 1: Test pressure 6 MPa and below	Until further notice

6.2.2.3 Service equipment

In the first table, for "ISO 13340:2001", in the column "Applicable for manufacture", replace "Until further notice" with "Until 31 December 2020".

In the first table, insert the following rows at the end:

ISO 14246:2014	Gas cylinders – Cylinder valves – Manufacturing tests and examination	Until further notice
ISO 17871:2015	Gas cylinders – Quick-release cylinders valves – Specification and type testing	Until further notice

6.2.2.4 Periodic inspection and test

Amend the end of the introductory sentence to read "...testing of UN cylinders and their closures:". Move the last row of the table into a new table, after the existing one, with the same headings and a new introductory sentence to read "The following standard applies to the periodic inspection and testing of UN metal hydride storage systems:"

In the table, for "ISO 11623:2002", in column "Applicable", replace "Until further notice" with "Until 31 December 2020". After the row for "ISO 11623:2002", insert the following new row:

ISO 11623:2015	Gas cylinders – Composite construction – Periodic inspection and testing	Until further notice
----------------	--	----------------------

At the end of the first table, insert the following row:

ISO 22434:2006	Transportable gas cylinders – Inspection and maintenance of cylinder valves <i>NOTE: These requirements may be met at times other than at the periodic inspection and test of UN cylinders.</i>	Until further notice
----------------	---	----------------------

6.2.2.7 Marking of refillable UN pressure receptacles

6.2.2.7.2 (c) Replace "indicated by the distinguishing signs of motor vehicles in international traffic" with "the distinguishing sign used on vehicles in international road traffic*".

6.2.2.7.4 Under sub-paragraph (m), insert a new note to read as follows:

Note: Information on marks that may be used for identifying threads for cylinders is given in ISO/TR 11364, *Gas cylinders – Compilation of national and international valve stem/gas cylinder neck threads and their identification and marking system.*

6.2.2.7.4 (n) Replace "indicated by the distinguishing signs of motor vehicles in international traffic" with "the distinguishing sign used on vehicles in international road traffic*".

6.2.2.7.7 (a) Replace "indicated by the distinguishing signs of motor vehicles in international traffic" with "the distinguishing sign used on vehicles in international road traffic*", and add the corresponding footnote * to read as follows:

* Distinguishing sign of the State of registration used on motor vehicles and trailers in international road traffic, e.g. in accordance with the Geneva Convention on Road Traffic of 1949 or the Vienna Convention on Road Traffic of 1968."

6.2.2.9 Marking of UN metal hydride storage systems

6.2.2.9.2 In (c) and (h), replace "indicated by the distinguishing signs of motor vehicles in international traffic" with "the distinguishing sign used on vehicles in international road traffic*"

6.2.2.9.4 (a) Replace "indicated by the distinguishing signs of motor vehicles in international traffic" with "the distinguishing sign used on vehicles in international road traffic*", and add the corresponding footnote * to read as follows:

- "* Distinguishing sign of the State of registration used on motor vehicles and trailers in international road traffic, e.g. in accordance with the Geneva Convention on Road Traffic of 1949 or the Vienna Convention on Road Traffic of 1968."

Chapter 6.3

Provisions for the construction and testing of packagings for class 6.2 infectious substances of category A

6.3.4 Marking

6.3.4.2 (e) Replace "indicated by the distinguishing sign for motor vehicles in international traffic" with "the distinguishing sign used on vehicles in international road traffic*", and add the corresponding footnote * to read as follows:

- "* Distinguishing sign of the State of registration used on motor vehicles and trailers in international road traffic, e.g. in accordance with the Geneva Convention on Road Traffic of 1949 or the Vienna Convention on Road Traffic of 1968."

Chapter 6.4

Provisions for the construction, testing and approval of packages and radioactive material

6.4.23 Applications for approval and approvals for radioactive material transport

6.4.23.11 In paragraph (a), replace "the international vehicle registration identification code*" with "the distinguishing sign used on vehicles in international road traffic*", and amend the footnote * to read as follows:

- "* Distinguishing sign of the State of registration used on motor vehicles and trailers in international road traffic, e.g. in accordance with the Geneva Convention on Road Traffic of 1949 or the Vienna Convention on Road Traffic of 1968."

Chapter 6.5

Provisions for the construction and testing of intermediate bulk containers (IBCs)

6.5.2 Marking

6.5.2.1 Primary marking

6.5.2.1.1.5 Replace "indicated by the distinguishing sign for motor vehicles in international traffic" with "indicated by the distinguishing sign used on vehicles in international road traffic*.", and add the corresponding footnote * to read as follows:

- "* Distinguishing sign of the State of registration used on motor vehicles and trailers in international road traffic, e.g. in accordance with the Geneva Convention on Road Traffic of 1949 or the Vienna Convention on Road Traffic of 1968."

6.5.6.9 Drop test

6.5.6.9.3 Amend the last paragraph to read as follows:

"The same IBC or a different IBC of the same design may be used for each drop."

6.5.6.14 Test report

6.5.6.14.1.8 At the end of the sub-paragraph, add the following sentence: "For rigid plastics and composite IBCs subject to the hydraulic pressure test in 6.5.6.8, the temperature of the water used;"

Chapter 6.6 Provisions for the construction and testing of large packagings

6.6.3 Marking

6.6.3.1 Primary marking

6.6.3.1 (e) Replace indicated by the distinguishing sign for motor vehicles in international traffic" with "indicated by the distinguishing sign used on vehicles in international road traffic", and add the corresponding footnote * to read as follows:

"* Distinguishing sign of the State of registration used on motor vehicles and trailers in international road traffic, e.g. in accordance with the Geneva Convention on Road Traffic of 1949 or the Vienna Convention on Road Traffic of 1968."

Chapter 6.7 Provisions for the design, construction, inspection and testing of portable tanks and multiple-element gas containers (MEGCs)

6.7.2 Provisions for the design, construction, inspection and testing of portable tanks intended for the transport of substances of class 1 and classes 3 to 9

6.7.2.18.1 In the fifth sentence, replace "i.e. the distinguishing sign for use in international traffic as prescribed by the Convention on Road Traffic, Vienna 1968" with "indicated by the distinguishing sign used on vehicles in international road traffic".

6.7.3.14.1 In the fifth sentence, replace "i.e. the distinguishing sign for use in international traffic as prescribed by the Convention on Road Traffic, Vienna 1968" with "indicated by the distinguishing sign used on vehicles in international road traffic".

6.7.4.13.1 In the fifth sentence, replace "i.e. the distinguishing sign for use in international traffic as prescribed by the Convention on Road Traffic, Vienna 1968" with "indicated by the distinguishing sign used on vehicles in international road traffic".

6.7.5.11.1 In the fifth sentence, replace "i.e. the distinguishing sign for use in international traffic as prescribed by the Convention on Road Traffic, Vienna 1968" with "indicated by the distinguishing sign used on vehicles in international road traffic".

Add the following corresponding footnote*:

- "* Distinguishing sign of the State of registration used on motor vehicles and trailers in international road traffic, e.g. in accordance with the Geneva Convention on Road Traffic of 1949 or the Vienna Convention on Road Traffic of 1968."

Chapter 6.8 **Provisions for road tank vehicles**

Amend title of chapter 6.8 to read "Provisions for road tank vehicles and road gas elements vehicles".

6.8.1.1 Amend provision 6.8.1.1 to read as follows:

"6.8.1.1 Tank and elements support frameworks, fitting and tie-down attachments*

6.8.1.1.1 Road tank vehicles and road gas elements vehicles shall be designed and manufactured with supports to provide a secure base during transport and with suitable tie-down attachments. The tie-down attachments shall be located on the tank or elements support, or vehicle structure in such a manner that the suspension system is not left in free play."

6.8.3 Amend the title of 6.8.3 to read "Road tank vehicles and road gas elements vehicles for short international voyages"

6.8.3.4 Add a new provision 6.8.3.4 as follows:

"6.8.3.4 Road gas elements vehicles for compressed gases of class 2 (IMO Type 9)

6.8.3.4.1 General provisions

6.8.3.4.1.1 An IMO type 9 tank shall comply with the provisions of 6.8.3.4.2 and 6.8.3.4.3.

6.8.3.4.1.2 An IMO type 9 tank shall not be offered for transport by sea in a condition that would lead to venting during the voyage under normal conditions of transport.

6.8.3.4.2 Design and construction

6.8.3.4.2.1 An IMO type 9 tank shall comply with the provisions of 6.7.5 with the exception that the horizontal forces at right angles to the direction of travel shall be the MPM multiplied by the acceleration due to gravity (g)*; and that the inspection and testing shall be in accordance with the competent authority where the road gas elements vehicle is approved.

* For calculation purposes, $g = 9.81 \text{ m/s}^2$.

6.8.3.4.2.2 If the landing legs of an IMO type 9 tank are to be used as support structures, the loads specified in 6.7.5.2.8 shall be taken into account in their design and method of attachment. Any bending stress induced in the shell or the elements as a result of this manner of support shall also be included in the design calculations.

6.8.3.4.2.3 Securing arrangements (tie-down attachments) shall be fitted to the road gas elements vehicle support structure and the towing vehicle of an IMO type 9 tank. Semi-trailers unaccompanied by a towing vehicle shall be accepted for shipment only if the trailer supports and the securing arrangements and the position of stowage are agreed by the competent authority for sea transport, unless the approved Cargo Securing Manual includes this arrangement.

6.8.3.4.3 Approval, testing and marking

6.8.3.4.3.1 IMO type 9 tanks shall be approved for road transport by the competent authority for road transport.

6.8.3.4.3.2 The competent authority for sea transport shall issue additionally, in respect of an IMO type 9 tank, a certificate attesting compliance with the relevant design, construction and equipment provisions of this chapter and, where appropriate, the special provisions for the gases listed in the Dangerous Goods List. The certificate shall list the gases allowed to be transported.

6.8.3.4.3.3 An IMO type 9 tank shall be periodically tested and inspected in accordance with the provisions of the competent authority for road transport where the road gas elements vehicle is approved.

6.8.3.4.3.4 An IMO type 9 tank shall be marked in accordance with 6.7.5.13, as applicable. However, where the marking required by the competent authority for road transport is substantially in agreement with that of 6.7.5.13.1, it will be sufficient to endorse the metal plate attached to the IMO type 9 tank with "IMO 9".

"

Chapter 6.9 Provisions for the design, construction, inspection and testing of bulk containers

6.9.5 Requirements for the design, construction, inspection and testing of flexible bulk containers BK3

6.9.5.5 Marking

6.9.5.5.1 (e) Replace "indicated by the distinguishing signs for motor vehicles in international traffic" with "the distinguishing signs used on vehicles in international road traffic*", and add the following corresponding footnote *:

"* Distinguishing sign of the State of registration used on motor vehicles and trailers in international road traffic, e.g. in accordance with the Geneva Convention on Road Traffic of 1949 or the Vienna Convention on Road Traffic of 1968."

PART 7
PROVISIONS CONCERNING TRANSPORT OPERATIONS

Chapter 7.1
General stowage provisions

7.1.3 Stowage categories

7.1.3.1 Stowage categories for class 1

In the 3rd column for Stowage category 02, Stowage category 03, Stowage category 04 and Stowage category 05, replace "7.1.4.4.5" with "7.1.4.4.6", respectively.

7.1.4 Special stowage provisions

Renumber paragraphs 7.1.4.4.5 and 7.1.4.4.5.1 as 7.1.4.4.6 and 7.1.4.4.6.1, respectively.
Renumber paragraph 7.1.4.4.6 as 7.1.4.4.7.

Add a new paragraph 7.1.4.4.5 as follows:

"7.1.4.4.5 Transport to or from offshore oil platforms, mobile offshore drilling units and other offshore installations

Notwithstanding the stowage category indicated in column 16a of the Dangerous Goods List, UN 0124 JET PERFORATING GUNS, CHARGED, and UN 0494 JET PERFORATING GUNS, CHARGED, transported to or from offshore oil platforms, mobile offshore drilling units and other offshore installations may be stowed on deck in offshore well tool pallets, cradles or baskets provided that:

- .1 initiation devices shall be segregated from each other and from any jet perforating guns in accordance with the provisions of 7.2.7, and from any other dangerous goods in accordance with the provisions of 7.2.4 and 7.6.3.2, unless otherwise approved by the competent authority;
- .2 jet perforating guns shall be securely held in place during transport;
- .3 each shaped charge affixed to any gun shall not contain more than 112 g of explosives;
- .4 each shaped charge, if not completely enclosed in glass or metal, shall be fully protected by a metal cover following installation in the gun;
- .5 both ends of jet perforating guns shall be protected by means of steel end caps allowing for pressure release in the event of fire;
- .6 the total explosive content shall not exceed 95 kg per well tool pallet, cradle or basket; and

- .7 where more than one well tool pallet, cradle or basket is stowed "on deck", a minimum horizontal distance of 3 m shall be observed between them."

7.1.4.6 After 7.1.4.6.1, insert a new provision of 7.1.4.7 as follows:

"7.1.4.7 Stowage of stabilized dangerous goods

Substances, for which the word "STABILIZED" is added as part of the proper shipping name of the substances in accordance with 3.1.2.6, Stowage Category D and SW1 shall apply."

7.1.5 Stowage codes

Add a new SW30 as follows:

"SW30 For special stowage provisions, see 7.1.4.4.5."

**Chapter 7.2
General segregation provisions**

7.2.2 Definitions

7.2.2.2 In sub-paragraph .2, replace "risk" with "hazard".

7.2.3 Segregation provisions

7.2.3.3 Replace "risk" with "hazard", twice.

7.2.3.4 Replace "risk" with "hazard", replace "risks" with "hazards", and replace the sentence "segregation as for class 5.1, but "separated from" class 7." with "SG6 (segregation as for class 5.1), and SG19 (stow "separated from" class 7).".

7.2.4 Segregation table

7.2.4 In the third paragraph, replace "risk" with "hazard".

7.2.5 Segregation groups

7.2.5.1 Amend existing paragraph 7.2.5.1 to read as follows:

"7.2.5.1 For the purpose of segregation, dangerous goods having certain similar chemical properties have been grouped together in segregation groups as listed in 7.2.5.2. The entries allocated to these segregation groups are listed in 3.1.4.4 and are identified by a segregation group code in column 16b of the Dangerous Goods List."

7.2.5.2 Replace paragraph 7.2.5.2 with the following:

"7.2.5.2 The segregation group codes given in column 16b of the Dangerous Goods List are as specified below:

Segregation Group Code	Segregation Group	Description
SGG1	1	acids
SGG1a	1, entries marked *	* identifies strong acids
SGG2	2	ammonium compounds
SGG3	3	bromates
SGG4	4	chlorates
SGG5	5	chlorites
SGG6	6	cyanides
SGG7	7	heavy metals and their salts (including their organometallic compounds)
SGG8	8	hypochlorites
SGG9	9	lead and its compounds
SGG10	10	liquid halogenated hydrocarbons
SGG11	11	mercury and mercury compounds
SGG12	12	nitrites and their mixtures
SGG13	13	perchlorates
SGG14	14	permanganates
SGG15	15	powdered metals
SGG16	16	peroxides
SGG17	17	azides
SGG18	18	alkalis

7.2.6 Special segregation provisions and exemptions

7.2.6.1 Replace "risk" with "hazard".

7.2.6.2 Under "For example", replace the sentence "segregation as for class 3, but "away from" classes 4.1 and 8." with "SG5 ("segregation as for class 3)", "SG8 (stow "away from" class 4.1)" and "SG13 (stow "away from class 8)"".

7.2.6.3 In provision .2, replace the last sentence to read "Substances within the same table 7.2.6.3.1, 7.2.6.3.2 or 7.2.6.3.3 are compatible with one another.". After .2, add a new provision .3 as follows:

".3 to substances within the table 7.2.6.3.4, except that due regard shall continue to be taken of the dangerous reactions specified in the provisions of 7.2.6.1.1 to 7.2.6.1.4."

In tables 7.2.6.3.1, 7.2.6.3.2 and 7.2.6.3.3, in the title of column 4, replace "subsidiary risk(s)" with "subsidiary hazard(s)", respectively.

7.2.6.3.3 After the existing table 7.2.6.3.3, insert a new table 7.2.6.3.4 as follows:

"Table 7.2.6.3.4

UN*	Proper Shipping Name	Class	Subsidiary Hazard(s)	Packing group
3101	ORGANIC PEROXIDE TYPE B, LIQUID	5.2	1 and/or 8	-
3102	ORGANIC PEROXIDE TYPE B, SOLID	5.2	1 and/or 8	-
3103	ORGANIC PEROXIDE TYPE C, LIQUID	5.2	None or 8	-
3104	ORGANIC PEROXIDE TYPE C, SOLID	5.2	None or 8	-
3105	ORGANIC PEROXIDE TYPE D, LIQUID	5.2	None or 8	-
3106	ORGANIC PEROXIDE TYPE D, SOLID	5.2	None or 8	-

UN*	Proper Shipping Name	Class	Subsidiary Hazard(s)	Packing group
3107	ORGANIC PEROXIDE TYPE E, LIQUID	5.2	None or 8	-
3108	ORGANIC PEROXIDE TYPE E, SOLID	5.2	None or 8	-
3109	ORGANIC PEROXIDE TYPE F, LIQUID	5.2	None or 8	-
3110	ORGANIC PEROXIDE TYPE F, SOLID	5.2	None or 8	-
3111	ORGANIC PEROXIDE TYPE B, LIQUID, TEMPERATURE CONTROLLED	5.2	1 and/or 8	-
3112	ORGANIC PEROXIDE TYPE B, SOLID, TEMPERATURE CONTROLLED	5.2	1 and/or 8	-
3113	ORGANIC PEROXIDE TYPE C, LIQUID, TEMPERATURE CONTROLLED	5.2	None or 8	-
3114	ORGANIC PEROXIDE TYPE C, SOLID, TEMPERATURE CONTROLLED	5.2	None or 8	-
3115	ORGANIC PEROXIDE TYPE D, LIQUID, TEMPERATURE CONTROLLED	5.2	None or 8	-
3116	ORGANIC PEROXIDE TYPE D, SOLID, TEMPERATURE CONTROLLED	5.2	None or 8	-
3117	ORGANIC PEROXIDE TYPE E, LIQUID, TEMPERATURE CONTROLLED	5.2	None or 8	-
3118	ORGANIC PEROXIDE TYPE E, SOLID, TEMPERATURE CONTROLLED	5.2	None or 8	-
3119	ORGANIC PEROXIDE TYPE F, LIQUID, TEMPERATURE CONTROLLED	5.2	None or 8	-
3120	ORGANIC PEROXIDE TYPE F, SOLID, TEMPERATURE CONTROLLED	5.2	None or 8	-
1325	FLAMMABLE SOLID, ORGANIC, N.O.S. with a technical name as listed in 2.5.3.2.4 under "exempt"	4.1	None	II, III

* Except for substances with the technical name PEROXYACETIC ACID

7.2.6.4 Renumber the exiting paragraph 7.2.6.4 as new paragraph 7.2.6.5. Insert a new paragraph 7.2.6.4 as follows:

"7.2.6.4 Notwithstanding table 7.2.6.3.2.4, due regard shall continue to be taken of the dangerous reactions specified in the provisions of 7.2.6.1.1 to 7.2.6.1.4."

7.2.8 Segregation codes

7.2.8 In the entry for SG1, replace the description as follows:

"For packages carrying a subsidiary hazard label of class 1, segregation as for class 1, division 1.3. However, in relation to goods of class 1, segregation as for the primary hazard.",

and amend the description of the following SG codes in 7.2.8 to include the corresponding SGG code for the segregation groups as follows:

Segregation Code	Description
SG20	Stow "away from" SGG1 – acids.
SG21	Stow "away from" SGG18 – alkalis.
SG24	Stow "away from" SGG17 – azides.
SG28	Stow "away from" SGG2 – ammonium compounds and explosives containing ammonium compounds or salts.
SG30	Stow "away from" SGG7 – heavy metals and their salts.
SG31	Stow "away from" SGG9 – lead and its compounds.

Segregation Code	Description
SG32	Stow "away from" SGG10 – liquid halogenated hydrocarbons.
SG33	Stow "away from" SGG15 – powdered metals.
SG34	When containing ammonium compounds, "away from" SGG4 – chlorates or SGG13 – perchlorates and explosives containing chlorates or perchlorates.
SG35	Stow "separated from" SGG1 – acids.
SG36	Stow "separated from" SGG18 – alkalis.
SG38	Stow "separated from" SGG2 – ammonium compounds.
SG39	Stow "separated from" SGG2 – ammonium compounds other than AMMONIUM PERSULPHATE (UN 1444).
SG40	Stow "separated from" SGG2 – ammonium compounds other than mixtures of ammonium persulphates and/or potassium persulphates and/or sodium persulphates.
SG42	Stow "separated from" SGG3 – bromates.
SG45	Stow "separated from" SGG4 – chlorates.
SG47	Stow "separated from" SGG5 – chlorites.
SG49	Stow "separated from" SGG6 – cyanides.
SG51	Stow "separated from" SGG8 – hypochlorites.
SG54	Stow "separated from" SGG11 – mercury and mercury compounds.
SG56	Stow "separated from" SGG12 – nitrites.
SG58	Stow "separated from" SGG13 – perchlorates.
SG59	Stow "separated from" SGG14 – permanganates.
SG60	Stow "separated from" SGG16 – peroxides.
SG61	Stow "separated from" SGG15 – powdered metals.
SG70	For arsenic sulphides, "separated from" SGG1 – acids.
SG75	Stow "separated from" SGG1a – strong acids.

Add three new segregation codes as follows:

SG76	Segregation as for class 7.
SG77	Segregation as for class 8. However, in relation to class 7, no segregation needs to be applied.
SG78	Stow "separated longitudinally by an intervening complete compartment or hold from" division 1.1, 1.2, and 1.5.

Annex

In the examples of the Annex, paragraphs 1.1, 3.2 and 4.2, replace "risk" with "hazard".

Chapter 7.3 Consigning operations concerning the packing and use of cargo transport units (CTUs) and related provisions

7.3.4 Segregation provisions within cargo transport units

7.3.4.2.1 Replace "risk" with "hazard".

7.3.4.2.2.3 Replace "risk" with "hazard".

7.3.7 Cargo transport units under temperature control

Replace the existing provisions of 7.3.7 with the following:

"7.3.7 Cargo transport units under temperature control

7.3.7.1 Preamble

7.3.7.1.1 If the temperature of certain substances (such as organic peroxides and polymerizing or self-reactive substances) exceeds a value which is typical of the substance as packaged for transport, a self-accelerating decomposition or polymerization possibly of explosive violence, may result. To prevent such decomposition or polymerization, it is necessary to control the temperature of such substances during transport. Other substances not requiring temperature control for safety reasons may be transported under controlled temperature conditions for commercial reasons.

7.3.7.1.2 The provisions for the temperature control of certain specified substances are based on the assumption that the temperature in the immediate surroundings of the cargo does not exceed 55°C during transport and attains this value for a relatively short time only during each period of 24 h.

7.3.7.2 General provisions

7.3.7.2.1 Where a number of packages containing self-reactive substances, organic peroxides and polymerizing substances are loaded in a closed cargo transport unit, the total quantity of substance, the type and number of packages and the stacking arrangement shall not create an explosion hazard.

7.3.7.2.2 These provisions apply to certain self-reactive substances when required by 2.4.2.3.4, and certain organic peroxides when required by 2.5.3.4.1 and certain polymerizing substances when required by 2.4.2.5.2 or special provision 386 of chapter 3.3 which may only be transported under conditions where the temperature is controlled.

7.3.7.2.3 These provisions also apply to the transport of substances for which:

- .1 the proper shipping name as indicated in column 2 of the Dangerous Goods List of chapter 3.2 or according to 3.1.2.6 contains the word "STABILIZED"; and
- .2 the self-accelerating decomposition temperature (SADT) or the self-accelerating polymerization temperature (SAPT)⁵ determined for the substance (with or without chemical stabilization) as offered for transport is:
 - .1 50°C or less for single packagings and IBCs; or
 - .2 45°C or less for portable tanks.

⁵ The SAPT shall be determined in accordance with the test procedures established for the SADT for self reactive substances in accordance with part II, section 28 of the Manual of Tests and Criteria.

When chemical inhibition is not used to stabilize a reactive substance which may generate dangerous amounts of heat and gas, or vapour, under normal transport conditions, these substances need to be transported under temperature control. These provisions do not apply to substances which are stabilized by the addition of chemical inhibitors such that the SADT or the SAPT is greater than that prescribed in paragraphs 7.3.7.2.3.2.1 or 7.3.7.2.3.2.2.

7.3.7.2.4 In addition, if a self-reactive substance or organic peroxide or a substance the proper shipping name of which contains the word "STABILIZED" and which is not normally required to be transported under temperature control is transported under conditions where the temperature may exceed 55°C, it may require temperature control.

7.3.7.2.5 The "control temperature" is the maximum temperature at which the substance can be safely transported. In the event of loss of temperature control, it may be necessary to implement emergency procedures. The "emergency temperature" is the temperature at which such procedures shall be implemented.

7.3.7.2.6 Derivation of control and emergency temperatures

Type of receptacle	SADT ^a /SAPT ^a	Control temperature	Emergency temperature
Single packagings and IBCs	20°C or less over 20°C to 35°C over 35°C	20°C below SADT/SAPT 15°C below SADT/SAPT 10°C below SADT/SAPT	10°C below SADT/SAPT 10°C below SADT/SAPT 5°C below SADT/SAPT
Portable tanks	≤ 45°C	10°C below SADT/SAPT	5°C below SADT/SAPT

^a i.e. the SADT/SAPT of the substance as packed for transport.

7.3.7.2.7 The control and emergency temperatures are derived using the table in 7.3.7.2.6 from the self-accelerating decomposition temperature (SADT) or from the self-accelerating polymerization temperature (SAPT) which are defined as the lowest temperatures at which self-accelerating decomposition or self-accelerating polymerization may occur with a substance in the packaging, IBC or portable tank as used in transport. An SADT or SAPT shall be determined in order to decide if a substance shall be subjected to temperature control during transport. Provisions for the determination of the SADT and SAPT are given in 2.4.2.3.4, 2.5.3.4.2 and 2.4.2.5.2 for self-reactive substances, organic peroxides and polymerizing substances and mixtures, respectively.

7.3.7.2.8 Control and emergency temperatures, where appropriate, are provided for currently assigned self-reactive substances in 2.4.2.3.2.3 and for currently assigned organic peroxide formulations in 2.5.3.2.4.

7.3.7.2.9 The actual transport temperature may be lower than the control temperature but shall be selected so as to avoid dangerous separation of phases.

7.3.7.3 Transport under temperature control

7.3.7.3.1 Prior to the use of cargo transport unit, the refrigeration system shall be subjected to a thorough inspection and a test to ensure that all parts are functioning properly.

7.3.7.3.2 Refrigerant gas shall only be replaced in accordance with the manufacturer's operating instructions for the refrigeration system. Prior to filling replacement refrigerant gas, a certificate of analysis from the supplier shall be obtained and checked to confirm that the gas meets refrigeration system specifications. In addition, if concerns about the integrity of the supplier and/or the refrigerant gas supply chain give rise to suspicion of contamination of the gas, the replacement refrigerant gas shall be checked for possible contamination prior to use. If the refrigerant gas is found to be contaminated, it shall not be used, the cylinder shall be plainly marked "CONTAMINATED", the cylinder shall be sealed and sent for recycling or disposal, and notification shall be given to the refrigerant gas supplier and authorized distributor and competent authority(ies) of the countries in which the supplier and distributor reside, as appropriate. The date of last refrigerant replacement shall be included in the maintenance record of the refrigeration system.

Note: Contamination can be checked by using flame halide lamp tests, gas sniffer tube tests or gas chromatography. Replacement refrigerant gas cylinders may be marked with the test result and the date of testing.

7.3.7.3.3 When a cargo transport unit is to be filled with packages containing substances having different control temperatures, all packages shall be pre-cooled to avoid exceeding the lowest control temperature.

7.3.7.3.3.1 In the event that non-temperature-controlled substances are transported in the same cargo transport unit as temperature controlled substances, the package(s) containing substances that require refrigeration shall be stowed in such a way as to be readily accessible from the door(s) of the cargo transport unit.

7.3.7.3.3.2 If substances with different control temperatures are loaded in the cargo transport unit, the substances with the lowest control temperature shall be stowed in the most readily accessible position from the doors of the cargo transport unit.

7.3.7.3.3.3 The door(s) shall be capable of being opened readily in case of emergency so that the package(s) can be removed. The carrier shall be informed about the location of the different substances within the unit. The cargo shall be secured to prevent packages from falling when the door(s) is (are) opened. The packages shall be securely stowed so as to allow for adequate air circulation throughout the cargo.

7.3.7.3.4 The master shall be provided with operating instructions for the refrigeration system, procedures to be followed in the event of loss of control and instructions for regular monitoring of operating temperatures. Spare parts shall be carried for the systems described in 7.3.7.4.2.3, 7.3.7.4.2.4 and 7.3.7.4.2.5 so that they are available for emergency use should the refrigeration system malfunction during transport.

7.3.7.3.5 In cases where it may not be possible to carry specific substances according to the general provisions, full details of the proposed method of shipment shall be submitted to the competent authority concerned for approval.

7.3.7.4 Methods of temperature control

7.3.7.4.1 The suitability of a particular means of temperature control for transport depends on a number of factors. Among those to be considered are:

- .1 the control temperature(s) of the substance(s) to be transported;
- .2 the difference between the control temperature and the anticipated ambient temperature conditions;
- .3 the effectiveness of the thermal insulation of the cargo transport unit. The overall heat transfer coefficient shall not be more than 0.4 W/(m²·K) for cargo transport units and 0.6 W/(m²·K) for tanks; and
- .4 the duration of the voyage.

7.3.7.4.2 Suitable methods for preventing the control temperature being exceeded are, in order of increasing capability:

- .1 thermal insulation, provided that the initial temperature of the substance is sufficiently below the control temperature;
- .2 thermal insulation with a cooling method, provided that:
 - an adequate quantity of non-flammable coolant (such as liquid nitrogen or solid carbon dioxide), allowing a reasonable margin for delay, is carried;
 - liquid oxygen or air is not used as a coolant;
 - there is a uniform cooling effect even when most of the coolant has been consumed; and
 - the need to ventilate the cargo transport unit before entering is clearly indicated by a warning on the door(s) (see 5.5.3);
- .3 single mechanical refrigeration, provided that the unit is thermally insulated and, for substances with a flashpoint lower than the sum of the emergency temperature plus 5°C, explosion proof electrical fittings are used within the cooling compartment to prevent ignition of flammable vapours from the substances;
- .4 combined mechanical refrigeration system and cooling method, provided that:
 - the two systems are independent of one another; and
 - the provisions of 7.3.7.4.2.2 and 7.3.7.4.2.3 are met;

- .5 dual mechanical refrigeration system, provided that:
- apart from the integral power supply unit, the two systems are independent of one another;
 - each system alone is capable of maintaining adequate temperature control; and
 - for substances with a flashpoint lower than the sum of the emergency temperature plus 5°C, explosion proof electrical fittings are used within the coolant compartment to prevent ignition of flammable vapours from the substances.

7.3.7.4.3 The refrigeration equipment and its controls shall be readily and safely accessible and all electrical connections weatherproof. Inside the cargo transport unit, the temperature shall be measured continuously. The measurement shall be taken in the air space of the unit, using two measuring devices independent of each other. The type and place of the measuring devices shall be selected so that their results are representative of the actual temperature in the cargo. At least one of the two measurements shall be recorded in such a manner that temperature changes are easily detectable. The temperature shall be checked every four to six hours and logged.

7.3.7.4.4 If substances are transported with a control temperature less than +25°C, the cargo transport unit shall be equipped with a visible and audible alarm effectively set at no higher than the control temperature. The alarms shall work independently from the power supply of the refrigeration system.

7.3.7.4.5 If an electrical supply is necessary for the cargo transport unit to operate the refrigeration or heating equipment, it shall be ensured that the correct connecting plugs are fitted. For under deck stowage, plugs shall, as a minimum, be of an IP 55 enclosure in accordance with IEC Publication 60529,⁶ with the specification for electrical equipment of temperature class T4 and explosion group IIB. However, when stowed on deck, these plugs shall be of an IP 56 enclosure in accordance with IEC Publication 60529.⁶

7.3.7.5 Special provisions for self-reactive substances, organic peroxides and polymerizing substances

7.3.7.5.1 For self-reactive substances (class 4.1) identified by UN Nos. 3231 and 3232 and organic peroxides (class 5.2) identified by UN Nos. 3111 and 3112, one of the following methods of temperature control described in 7.3.7.4.2 shall be used:

- .1 the methods referred to under 7.3.7.4.2.4 or 7.3.7.4.2.5; or
- .2 the method referred to under 7.3.7.4.2.3 when the maximum ambient temperature to be expected during transport is at least 10°C below the control temperature.

7.3.7.5.2 For self-reactive substances (class 4.1) identified by UN Nos. 3233 to 3240, organic peroxides (class 5.2) identified by UN Nos. 3113 to 3120 and

⁶ Reference is made to the Recommendations published by the International Electrotechnical Commission (IEC) and, in particular, to publication 60529 Classification of Degrees of Protection provided by Enclosures.

polymerizing substances identified by UN Nos. 3533 and 3534 or for those substances where the words "TEMPERATURE CONTROLLED" are added as part of the proper shipping name in accordance with 3.1.2.6.2, one of the following methods shall be used:

- .1 the methods referred to under 7.3.7.4.2.4 or 7.3.7.4.2.5;
- .2 the method referred to under 7.3.7.4.2.3 when the maximum ambient temperature to be expected during transport does not exceed the control temperature by more than 10°C; or
- .3 for short international voyages only (see 1.2.1), the methods referred to under 7.3.7.4.2.1 and 7.3.7.4.2.2 when the maximum ambient temperature to be expected during transport is at least 10°C below the control temperature.

7.3.7.6 Special provisions for flammable gases or liquids having a flashpoint less than 23°C c.c. transported under temperature control

7.3.7.6.1 When flammable gases or liquids having a flashpoint less than 23°C c.c. are packed or loaded in a cargo transport unit equipped with a refrigerating or heating system, the cooling or heating equipment shall comply with 7.3.7.4.

7.3.7.6.2 When flammable liquids having a flashpoint less than 23°C c.c. and not requiring temperature control for safety reasons are transported under temperature control conditions for commercial reasons, explosion proof electrical fittings are required except when the substances are pre-cooled to and transported at a control temperature of at least 10°C below the flashpoint. In case of failure of a non-explosion proof refrigerating system, the system shall be disconnected from the power supply. It shall not be reconnected if the temperature has risen to a temperature less than 10°C below the flashpoint.

7.3.7.6.3 When flammable gases not requiring temperature control for safety reasons are transported under temperature control conditions for commercial reasons, explosion proof electrical fittings are required.

7.3.7.7 Special provisions for vehicles transported on ships

Insulated, refrigerated and mechanically refrigerated vehicles shall conform to the provisions of 7.3.7.4 and 7.3.7.5 as appropriate. In addition, the refrigerating appliance of a mechanically refrigerated vehicle shall be capable of operating independently of the engine used to propel the vehicle.

7.3.7.8 Approval

The competent authority may approve that less stringent means of temperature control may be used or that artificial refrigeration may be dispensed with under conditions of transport such as short international voyages or low ambient temperatures.

"

Chapter 7.4

Stowage and segregation on containerships

7.4.2 Stowage requirements

7.4.2.4.1 Replace "risk" with "hazard", twice.

7.4.2.3.2 Replace the existing paragraph with the following:

"7.4.2.3.2 A container with flammable gases or flammable liquids having a flashpoint of less than 23°C c.c. transported on deck shall be stowed at least 2.4 m horizontally and projected vertically away from any potential source of ignition."

Chapter 7.6

Stowage and segregation on general cargo ships

7.6.2 Stowage and handling provisions

7.6.2.3.1 Replace "risk" with "hazard", twice.

7.6.3 Segregation provisions

7.6.3.1.2 Replace "risk" with "hazard".

Chapter 7.7

Shipborne barges on barge-carrying ships

7.7.3 Barge loading

7.7.3.6 Replace "risk" with "hazard".

7.7.3.7.3 Replace "risk" with "hazard".

Chapter 7.8

Special requirements in the event of an incident and fire precautions involving dangerous goods

7.8.1 General

7.8.1.1 Add "*Revised*" before "*Emergency Response Procedures for Ships Carrying Dangerous Goods (EmS Guide)*".

7.8.4 Special provisions for incidents involving radioactive material

7.8.4.4 Add "*Revised*" before "*Emergency Response Procedures for Ships Carrying Dangerous Goods (EmS Guide)*".

Chapter 7.9

Exemptions, approvals and certificates

7.9.3 Contact information for the main designated national competent authorities

Updated the following contact information for national competent authority regarding the IMDG Code:

AZERBAIJAN	<p>Ministry of Emergency Situations of the Republic of Azerbaijan State Agency for Safe Working in Industry and Mountain-Mine Control 26 Najafgulu Rafiyev Street Baku Khatai Region AZ 1025 Azerbaijan Telephone: +994 12 512 1501 Telefax: +994 12 512 2501 Email: dag-meden@fhn.gov.az</p>
CHILE	<p>Dirección General del Territorio Marítimo y de Marina Mercante Empcontra Milton Pizarro Barrella Dirección de Seguridad y Operaciones Marítimas Departamento Policía Marítima y Prevención de Riesgos División Cargas Peligrosas Subida Cementerio No.300, Playa Ancha Valparaíso 2520000 Chile Telephone: +56 32 220 8607 +56 32 220 8656 Email: mpizarrob@directemar.cl mmunoza@directemar.cl gsage@directemar.cl Website: http://www.directemar.cl</p>
ECUADOR	<p>SUBSECRETARIA DE PUERTOS Y TRANSPORTE MARITIMO Y FLUVIAL ING. IVAN SOLORZANO VILLACIS EXPERTO EN INFRAESTRUCTURA PORTUARIA CDLA. LOS CEIBOS - AV. DEL BOMBERO Y LEPOLDO CARRERA - EDIF. "GRACE" EP-PETROECUADOR - 1ER PISO GUAYAQUIL GUAYAS Ecuador Telephone: +593 4259 2080 Email: isolorzano@mtop.gob.ec Website: http://www.obraspublicas.gob.ec</p> <p>SUBSECRETARIA DE PUERTOS Y TRANSPORTE MARITIMO Y FLUVIAL (SPTMF) Ing. Richard Villacís Jefe de Contaminación Av. del Bombero y Leopoldo Carrera – Cdl. Ceibos. Edif. EP-Petroecuador. 1er piso Guayaquil Ecuador Telephone: +593 6272 3008 Email: rvillacis@mtop.gob.ec Website: https://www.obraspublicas.gob.ec</p>

	<p>Superintendencia del Terminal Petrolero de "El Salitral" (SUINSA) CPNV(SP) Raúl Aguirre Baldeón Superintendente Terminal Petrolero de el Salitral Guayaquil Ecuador Telephone: +593 4550 4901 Telefax: +593 4250 4901 Ext. 102/109 Email: suinsa_operaciones@mtop.gob.ec suinsa_radio@mtop.gob.ec raguirreb2000@hotmail.com</p> <p>Superintendencia del Terminal Petrolero de la Libertad (SUINLI) CPNV(SP) Roberto Ruiz Johns Superintendente Terminal Petrolero de la Libertad La Libertad Ecuador Telephone: +593 4278 5785 Telefax: +593 4278 5781 Email: suinli_operaciones@mtop.gob.ec suinli_radio@mtop.gob.ec r Ruiz@mtop.gob.ec</p>
FAROES (THE)	<p>Sjóvinnustýrið Faroese Maritime Authority P.O. Box 26 Á Hálsi 1, P.O. Box 26 Sørvágur FO-380 Faroes, DenmarkInni á Støð, P. O. Box 26 FO-375 Miðvágur, Faroe Islands Telephone: +298 35 5600 Telefax: +298 35 5601 Email: fma@fma.fo Website: https://www.fma.fo</p>
FRANCE	<p>Ministère de la Transition Ecologique et Solidaire Adjoint au Chef de la mission transport de matières dangereuses Mr Pierre DUFOUR MTES – DGPR – Mission Transport de matières dangereuses (MTMD) Tour Séquoia - Pièce 23-39 92055 Paris La Défense Cedex France Telephone: +33 1 4081 1496 Telefax: +33 1 4081 8641 Email: pierre.dufour@developpement-durable.gouv.fr</p> <p><i>Organizations authorized for packagings, large packagings and intermediate bulk containers (IBCs)⁷</i></p>

	<p>1 Association des Contrôleurs Indépendants (ACI) 22, rue de l'Est 92100 Boulogne-Billancourt France</p> <p>2 APAVE 191, rue de Vaugirard 75738 Paris Cedex 15 France</p> <p>3 Association pour la Sécurité des Appareils à Pression (ASAP) Continental Square – BP 16757 95727 Roissy-Charles de Gaulle Cedex France</p> <p>4 Bureau de Vérifications Techniques (BVT) ZAC de la Cerisaie – 31, rue de Montjean 94266 Fresnes Cedex France</p> <p>5 Bureau Veritas 67-71, rue du Château 92200 Neuilly-sur-Seine France</p> <p>6 Centre Français de l'Emballage Agréé (CeFEA) 5, rue Janssen 75019 Paris France</p> <p>7 Laboratoire d'Études et de Recherches des Emballages Métalliques (LEREM) Marches de l'Oise – 100, rue Louis-Blanc 60160 Montataire France</p> <p>8 Laboratoire National de métrologie et d'Essais (LNE) 1, rue Gaston-Boissier 75724 Paris Cedex 15 France</p> <p><i>Organizations authorized for pressure receptacles⁷</i></p> <p>1 Association des Contrôleurs Indépendants (ACI) (Voir coordonnées ci-dessus)</p> <p>2 APAVE (Voir coordonnées ci-dessus)</p> <p>3 Association pour la Sécurité des Appareils à Pression (ASAP) (Voir coordonnées ci-dessus)</p> <p>4 Bureau Veritas (Voir coordonnées ci-dessus)</p>
--	---

	<p><i>Organizations authorized for tanks and multiple-element gas containers (MEGCs)⁷</i></p> <p>1 Association des Contrôleurs Indépendants (ACI) (Voir coordonnées ci-dessus)</p> <p>2 APAVE (Voir coordonnées ci-dessus)</p> <p>3 Bureau Veritas (Voir coordonnées ci-dessus)</p>
GERMANY	<p>Ministry of Transport and digital Infrastructure Division G 24 - Transport of Dangerous Goods Robert-Schuman-Platz 1</p> <p>Telephone: +49 (0) 228 300 2551 Email : ref-g24@bmvi.bund.de</p>
ICELAND	<p>Icelandic Transport Authority (ICETRA) Armuli 2 Reykjavik 108 Iceland</p> <p>Telephone: +354 480 6000 Email: samgongustofa@samgongustofa.is</p>
IRAN (ISLAMIC REPUBLIC OF)	<p>Ports and Maritime Organization PMO. No.1. Shahidi St. Haghani Exp'way Vanak Sq. Tehran 1518663111 Iran (Islamic Republic of)</p> <p>Telephone: +98 21 8493 2081/2 Email: info@pmo.ir</p>
ITALY	<p>Comando Generale del Corpo delle Capitanerie di Porto Lt. Cdr. (IT.C.G.) Giuseppe Notte Ufficio II - Merci Pericolose Via dell'Arte, 16 Roma 00144 Italy</p> <p>Telephone: +39 06 5908 4267 +39 06 5908 4652 Telefax: +39 06 5908 4630 Email: cgcp@pec.mit.gov.it segreteria.reparto6@mit.gov.it Website: http://www.guardiacostiera.gov.it</p>

⁷ Contact competent authority for further details of areas of authorization.

<p>JAPAN</p>	<p>Inspection and Measurement Division Maritime Bureau Ministry of Land, Infrastructure, Transport and Tourism 2-1-3 Kasumigaseki, Chiyoda-ku Tokyo Japan Telephone: +81 3 5253 8639 Telefax: +81 3 5253 1644 Email: hqt-MRB_KSK@ml.mlit.go.jp</p> <p>Packaging Testing and Certification Institute Nippon Hakuyohin Kentei Kyokai (HK) (The Ship Equipment Inspection Society of Japan) 3-32, Kioi-Cho, Chiyoda-ku Tokyo Japan Telephone: +81 3 3261 6611 Telefax: +81 3 3261 6979</p> <p>Packagings, IBCs and large packagings in conformity with the IMDG Code will be marked "J", "J/JG" or "J/HK".</p>
<p>MEXICO</p>	<p><i>Stowage, segregation, labelling and documentation of goods</i> Coordinación General de Puertos y Marina Mercante Secretaría de Comunicación y Transportes Boulevard Adolfo López Mateos No. 1990 Col. Los Alpes Tlacopac, Del. Álvaro Obregón, C.P. 01010 México, Distrito Federal Telephone: +52 55 5723 9300 Email: coordgral.cgpm@scgpm.com.mx Coordinador General: Ruiz de Teresa Guillermo Raúl</p> <p><i>Receipt and processing of notifications in the event of a package falling overboard</i> Secretaría de Marina Eje 2 Oriente, Tramo Heroica Escuela Naval Militar No. 861 Colonia Los Cipreses, C.P. 04830 México, Distrito Federal Telephone: +52 55 5624 6500 (extention: 6388) Email: ayjemg@semar.gob.mx Jefe del Estado Mayor General de la Armada de México: Vicealmirante C.G. DEM Joaquín Zetina Angulo</p> <p><i>Laboratory testing of packagings containing dangerous goods</i> Entidad Mexicana de Acreditación, A.C. Mariano Escobedo, No.564 Col. Nueva Anzures, Delegación Miguel Hidalgo C.P. 11590, Ciudad de México México Telephone: +52 55 9148 4300 Email: Maribel.lopez@ema.org.mx Directora Ejecutiva: Mtra. María Isabel López Martínez</p>

MONGOLIA	<p>Maritime Administration of Mongolia Division of Ship Registration and Regulation Government Building 11 Sambuu's street 11 Chingeltei district Ulaanbaatar 211238 Mongolia Telephone: +976 51 261 490 Telefax: +976 11 310 642 Email: info@monmarad.gov.mn operation@mngship.org Website: http://monmarad.gov.mn</p>
PERU	<p>Dirección General de Capitanías y Guardacostas (DICAPI) Jirón Constitución No.150 Callao Peru Telephone: +51 1209 9300 Anexo: 6757/6792 Email: jefemercanciaspeligrosas@dicapi.mil.pe</p>
PORTUGAL	<p>Direção-Geral de Recursos Naturais, Segurança e Serviços Marítimos (DGRM) Avenida Brasília Lisboa 1449-030 Portugal Telephone: +351 213 035 700 Telefax: +351 213 035 702 Email: dgrm@dgrm.mm.gov.pt</p>
SINGAPORE	<p>Maritime and Port Authority of Singapore Operations Divison, Assistant Director (Marine Environment & Safety) Capt Charles Alexandar De Souza #19-00 Tanjong Pagar Complex 7B Keppel Road, Singapore 089055 Telephone: +65 6325 2420 Telefax: +65 6325 2454 Email: Charles_Alexandar_De_Souza@mpa.gov.sg</p>
TURKEY	<p>Ministry of Transport Maritime Affairs and Communications Directorate General for Regulation of Dangerous Goods and Combined Transport GMK Bulvarı No:128A/7 Maltepe/Ankara 06570 Turkey Telephone: +90 312 232 3850 +90 312 232 1249 Fax: +90 312 231 5189 Email: dangerousgoods@udhb.gov.tr</p>

	<p>Packing, Testing and Certification Turkish Standards Institution (TSE) 100. Yıl Bulvarı No:99 Kat:2 Ostim/Ankara Turkey Telephone: +90 312 592 5000/5039 Fax: +90 312 592 5005 Email: oolper@tse.org.tr</p> <p>Türk Loydu Vakfı İktisadi İşletmesi Tersaneler Caddesi 26, 34944 Turkey Telephone: +90 216 581 3700 Fax: +90 216 581 3800 Email: info@turkloydu.org</p>
UNITED KINGDOM (Isle of Man)	<p>Department of Economic Development Mr David Morter Isle of Man Ship Registry St Georges Court Upper Church Street Douglas Douglas IM1 1EE Isle of Man (United Kingdom) Telephone: +44 1624 688500 Email: marine.survey@gov.im Website: http://www.iomshipregistry.com</p>
UNITED STATES	<p>US Department of Transportation Pipeline and Hazardous Materials Safety Administration International Program Coordinator 1200 New Jersey Ave S.E. Washington, D.C. 20590 United States Telephone: +1 202 366 8553 Telefax: +1 202 366 7435 Email: infocntr@dot.gov</p> <p>United States Coast Guard – Commandant (CG-ENG-5) U.S. Coast Guard, Stop 7509 Attn: Chief, Hazardous Materials Division 2703 Martin Luther King Jr. Ave. SE Washington, D.C. 20593-7509 United States Telephone: +1 202 372 1420 Email: hazmatstandards@uscg.mil</p>

Appendix A
List of generic and N.O.S. proper shipping names

In the List of generic and N.O.S. proper shipping names, header, column 2, replace "risk" with "hazard".

In the table, for class 2.1, under "General entries", after 3510, add the following new entry:

2.1	See 2.0.6.6	3537	ARTICLES CONTAINING FLAMMABLE GAS, N.O.S.
-----	-------------	------	---

In the table, for class 2.2, under "General entries", after 3511, add the following new entry:

2.2	See 2.0.6.6	3538	ARTICLES CONTAINING NON-FLAMMABLE, NON-TOXIC GAS, N.O.S.
-----	-------------	------	--

In the table, for class 2.3, under "General entries", after 3512, add the following new entry:

2.3	See 2.0.6.6	3539	ARTICLES CONTAINING TOXIC GAS, N.O.S.
-----	-------------	------	---------------------------------------

In the table, for class 3, under "General entries", after 3526, add the following new entry:

3	See 2.0.6.6	3540	ARTICLES CONTAINING FLAMMABLE LIQUID, N.O.S.
---	-------------	------	--

In the table, for class 4.1, under "General entries", after 3534, add the following new entry:

4.1	See 2.0.6.6	3541	ARTICLES CONTAINING FLAMMABLE SOLID, N.O.S.
-----	-------------	------	---

In the table, for class 4.2, under "General entries", after 3200, add the following new entry:

4.2	See 2.0.6.6	3542	ARTICLES CONTAINING A SUBSTANCE LIABLE TO SPONTANEOUS COMBUSTION, N.O.S.
-----	-------------	------	--

In the table, for class 4.3, under "General entries", after 2813, add the following new entry:

4.3	See 2.0.6.6	3543	ARTICLES CONTAINING A SUBSTANCE WHICH EMITS FLAMMABLE GAS IN CONTACT WITH WATER, N.O.S.
-----	-------------	------	---

In the table, for class 5.1, under "General entries", after 3139, add the following new entry:

5.1	See 2.0.6.6	3544	ARTICLES CONTAINING OXIDIZING SUBSTANCE, N.O.S.
-----	-------------	------	---

In the table, for class 5.2, after "Specific entries", add a new section "General entries" with the following new entry:

5.2	See 2.0.6.6	3545	ARTICLES CONTAINING ORGANIC PEROXIDE, N.O.S.
-----	-------------	------	--

In the table, for class 6.1, under "General entries", after 3489, add the following new entry:

6.1	4.1	3535	TOXIC SOLID, FLAMMABLE, INORGANIC, N.O.S.
-----	-----	------	---

In the table, for class 6.1, under "General entries", after 3462, add the following new entry:

6.1	See 2.0.6.6	3546	ARTICLES CONTAINING TOXIC SUBSTANCE, N.O.S.
-----	-------------	------	---

In the table, for class 8, under "General entries", after 3267, add the following new entry:

8	See 2.0.6.6	3547	ARTICLES CONTAINING CORROSIVE SUBSTANCE, N.O.S.
---	-------------	------	---

In the table, for class 9, under "General entries", after 3335, add the following new entry:

9	See 2.0.6.6	3548	ARTICLES CONTAINING MISCELLANEOUS DANGEROUS GOODS, N.O.S
---	-------------	------	--

INDEX

For the entry "2-DIMETHYLAMINOETHYL ACRYLATE", in the column "Substance, material or article", add ", STABILIZED" at the end.

Insert the following new entries in alphabetical order:

<i>Substance, material or article</i>	<i>MP</i>	<i>Class</i>	<i>UN No.</i>
ARTICLES CONTAINING FLAMMABLE GAS, N.O.S.	-	2.1	3537
ARTICLES CONTAINING NON-FLAMMABLE, NON-TOXIC GAS, N.O.S.	-	2.2	3538
ARTICLES CONTAINING TOXIC GAS, N.O.S.	-	2.3	3539
ARTICLES CONTAINING FLAMMABLE LIQUID, N.O.S.	-	3	3540
ARTICLES CONTAINING FLAMMABLE SOLID, N.O.S.	-	4.1	3541
ARTICLES CONTAINING A SUBSTANCE LIABLE TO SPONTANEOUS COMBUSTION, N.O.S.	-	4.2	3542
ARTICLES CONTAINING A SUBSTANCE WHICH EMITS FLAMMABLE GAS IN CONTACT WITH WATER, N.O.S.	-	4.3	3543
ARTICLES CONTAINING OXIDIZING SUBSTANCE, N.O.S.	-	5.1	3544
ARTICLES CONTAINING ORGANIC PEROXIDE, N.O.S.	-	5.2	3545
ARTICLES CONTAINING TOXIC SUBSTANCE, N.O.S.	-	6.1	3546
ARTICLES CONTAINING CORROSIVE SUBSTANCE, N.O.S.	-	8	3547
ARTICLES CONTAINING MISCELLANEOUS DANGEROUS GOODS, N.O.S.	-	9	3548
DI-(4-tert-butylcyclohexyl) peroxydicarbonate, see	-	5.2	3116
Diisobutyl peroxide, see	-	5.2	3119
1-dodecene, see	-	3	2850
LITHIUM BATTERIES INSTALLED IN CARGO TRANSPORT UNIT lithium ion batteries or lithium metal batteries	-	9	3536
1-Phenylethyl hydroperoxide, see	-	5.2	3109
Phosphorothioic acid, o-[(cyanophenyl methylene) azanyl] o,o-diethyl ester, see	-	4.1	3227
TOXIC SOLID, FLAMMABLE, INORGANIC, N.O.S.	-	6.1	3535

ANNEX 10

**RESOLUTION MSC.445(99)
(adopted on 24 May 2018)**

**AMENDMENTS TO THE CODE OF SAFETY FOR SPECIAL PURPOSE SHIPS, 2008
(2008 SPS CODE)**

THE MARITIME SAFETY COMMITTEE,

RECALLING Article 28(b) of the Convention on the International Maritime Organization concerning the functions of the Committee,

RECALLING ALSO resolution MSC.266(84), by which it adopted the Code of Safety for Special Purpose Ships, 2008 (2008 SPS Code),

NOTING the need to amend respective provisions of the Code,

NOTING ALSO that, by resolution MSC.436(99), it adopted amendments to SOLAS chapter IV and the appendix (Certificates) regarding the use of the term "recognized mobile satellite service",

HAVING CONSIDERED, at its ninety-ninth session, the consequential amendments to the Record of Equipment for Compliance with the 2008 SPS Code, proposed for adoption in conjunction with the adoption of amendments to SOLAS chapter IV and the appendix (Certificates),

1 ADOPTS amendments to the 2008 SPS Code, the text of which is set out in the annex to the present resolution;

2 DETERMINES that said amendments should become effective on 1 January 2020.

ANNEX

**AMENDMENTS TO THE CODE OF SAFETY FOR SPECIAL PURPOSE SHIPS, 2008
(2008 SPS CODE)**

ANNEX

FORM OF SAFETY CERTIFICATE FOR SPECIAL PURPOSE SHIPS

APPENDIX

**Record of Equipment for the Special Purpose Ship Safety Certificate
(Form SPS)**

**RECORD OF EQUIPMENT FOR COMPLIANCE WITH THE CODE OF SAFETY
FOR SPECIAL PURPOSE SHIPS**

3 Details of radio facilities

In section 1, the existing description of item 1.4 is amended to read as follows:

"Recognized mobile satellite service ship earth station".

ANNEX 11

**RESOLUTION MSC.446(99)
(adopted on 24 May 2018)**

**AMENDMENTS TO THE CODE FOR THE CONSTRUCTION AND EQUIPMENT
OF SHIPS CARRYING DANGEROUS CHEMICALS IN BULK (BCH CODE)**

THE MARITIME SAFETY COMMITTEE,

RECALLING Article 28(b) of the Convention on the International Maritime Organization concerning the functions of the Committee,

RECALLING ALSO resolution A.212(VII) by which the Assembly, at its seventh session, adopted the *Code for the Construction and Equipment of Ships Carrying Dangerous Chemicals in Bulk* (BCH Code), which provides safety requirements for chemical tankers supplementary to the provisions of the International Convention for the Safety of Life at Sea (SOLAS), 1974, as amended,

RECALLING FURTHER resolution MEPC.20(22), by which the Marine Environment Protection Committee (MEPC) adopted the BCH Code to make it mandatory under MARPOL,

NOTING resolution MSC.29(61), by which, at its sixty-first session, it adopted the revised BCH Code,

NOTING ALSO resolutions MSC.440(99) and MEPC.302(72), respectively, by which it, and MEPC, adopted corresponding amendments to the Certificate of Fitness under the International Code for the Construction and Equipment of Ships Carrying Dangerous Chemicals in Bulk (IBC Code),

NOTING FURTHER resolution MEPC.303(72) by which MEPC, at its seventy-second session, adopted amendments to the Certificate of Fitness under the BCH Code,

CONSIDERING that it is highly desirable for the provisions of the BCH Code, which are mandatory under MARPOL and recommendatory from a safety standpoint, to remain identical when adopted by the Marine Environment Protection Committee and the Maritime Safety Committee,

HAVING CONSIDERED, at its ninety-ninth session, amendments to the Certificate of Fitness under the BCH Code prepared by the Secretariat and, subsequently, approved by the Committee at its ninety-eighth session,

RECOGNIZING the need to bring the approved amendments to the BCH Code into force on the date on which corresponding amendment to the IBC Code enter into force,

1 ADOPTS amendments to the Certificate of Fitness under the Code for the Construction and Equipment of Ships Carrying Dangerous Chemicals in Bulk (BCH Code), as amended, the text of which is set out in the annex to the present resolution;

2 DETERMINES that said amendments shall become effective on 1 January 2020 upon acceptance and entry into force of the corresponding amendment to the Certificate of Fitness under the IBC Code, adopted by resolution MSC.440(99).

ANNEX

**AMENDMENTS TO THE CODE FOR THE CONSTRUCTION AND EQUIPMENT OF SHIPS
CARRYING DANGEROUS CHEMICALS IN BULK (BCH CODE)**

In the appendix, the existing paragraph 6 of the model form of Certificate of Fitness for the Carriage of Dangerous Chemicals in Bulk is replaced with the following:

- "6 That the loading and stability manuals required by paragraph 2.2.1.1 of the Code have been supplied to the ship in an approved form.
- 7 That the ship must be loaded:
- .1* only in accordance with loading conditions verified compliant with intact and damage stability requirements using the approved stability instrument fitted in accordance with paragraph 2.2.1.2 of the Code;
 - .2* where a waiver permitted by paragraph 2.2.1.3 of the Code is granted and the approved stability instrument required by paragraph 2.2.1.2 of the Code is not fitted, loading should be made in accordance with one or more of the following approved methods:
 - (i)* in accordance with the loading conditions provided in the approved loading and stability manuals referred to in 6 above; or
 - (ii)* in accordance with loading conditions verified remotely using an approved means; or
 - (iii)* in accordance with a loading condition which lies within an approved range of conditions defined in the approved loading and stability manuals referred to in 6 above; or
 - (iv)* in accordance with a loading condition verified using approved critical KG/GM data defined in the approved loading and stability manuals referred to in 6 above;
 - .3* in accordance with the loading limitations appended to this Certificate.

Where it is required to load the ship other than in accordance with the above instruction, then the necessary calculations to justify the proposed loading conditions should be communicated to the certifying Administration who may authorize in writing the adoption of the proposed loading condition.**

* Delete as appropriate.

** Instead of being incorporated in the Certificate, this text may be appended to the Certificate, if duly signed and stamped."

ANNEX 12

**RESOLUTION MSC.447(99)
(adopted on 24 May 2018)**

**AMENDMENTS TO THE CODE FOR THE CONSTRUCTION AND EQUIPMENT OF SHIPS
CARRYING LIQUEFIED GASES IN BULK (GC CODE)**

THE MARITIME SAFETY COMMITTEE,

RECALLING Article 28(b) of the Convention on the International Maritime Organization concerning the functions of the Committee,

RECALLING ALSO resolution A.328(IX) by which the Assembly, at its ninth session, adopted the *Code for the Construction and Equipment of Ships Carrying Liquefied Gases in Bulk* (GC Code),

NOTING resolution MSC.441(99), by which it adopted the corresponding amendments to the Certificate of Fitness under the International Code for the Construction and Equipment of Ships Carrying Liquefied Gases in Bulk (IGC Code),

HAVING CONSIDERED, at its ninety-ninth session, amendments to the Certificate of Fitness under the GC Code prepared by the Secretariat and, subsequently, approved by the Committee at its ninety-eighth session,

RECOGNIZING the need for the amendments to the GC Code to become effective on the date on which the corresponding amendments to the IGC Code enter into force,

1 ADOPTS amendments to the Certificate of Fitness under the Code for the Construction and Equipment of Ships Carrying Liquefied Gases in Bulk, as amended, the text of which is set out in the annex to the present resolution;

2 DETERMINES that the said amendments shall become effective on 1 January 2020 upon acceptance and entry into force of the corresponding amendments to the IGC Code adopted by resolution MSC.441(99).

ANNEX

**AMENDMENTS TO THE CODE FOR THE CONSTRUCTION AND EQUIPMENT OF SHIPS
CARRYING LIQUEFIED GASES IN BULK (GC CODE)**

1 In the appendix, the existing paragraph 6 of the model form of Certificate of Fitness for the Carriage of Liquefied Gases in Bulk is replaced with the following:

"6 That the loading and stability information booklet required by paragraph 2.2.3 of the Code has been supplied to the ships in an approved form.

7 That the ship must be loaded:

.1* only in accordance with loading conditions verified compliant with intact and damage stability requirements using the approved stability instrument fitted in accordance with paragraph 2.2.4 of the Code;

.2* where a waiver permitted by paragraph 2.2.5 of the Code is granted and the approved stability instrument required by paragraph 2.2.4 of the Code is not fitted, loading should be made in accordance with one or more of the following approved methods:

(i)* in accordance with the loading conditions provided in the approved loading and stability information booklet referred to in 6 above; or

(ii)* in accordance with loading conditions verified remotely using an approved means.....; or

(iii)* in accordance with a loading condition which lies within an approved range of conditions defined in the approved loading and stability information booklet referred to in 6 above; or

(iv)* in accordance with a loading condition verified using approved critical KG/GM data defined in the approved loading and stability information booklet referred to in 6 above;

.3* in accordance with the loading limitations appended to this Certificate.

Where it is required to load the ship other than in accordance with the above instruction, then the necessary calculations to justify the proposed loading conditions should be communicated to the certifying Administration who may authorize in writing the adoption of the proposed loading condition.**

* Delete as appropriate.

** Instead of being incorporated in the Certificate, this text may be appended to the Certificate, if duly signed and stamped."

ANNEX 13

AMENDMENTS TO THE CODE FOR EXISTING SHIPS CARRYING LIQUIFIED GASES IN BULK (EGC CODE)

1 In the appendix, the existing paragraph 6 of the model form of Certificate of Fitness for the Carriage of Liquefied Gases in Bulk is replaced with the following:

"6 That the loading and stability information booklet required by paragraph 2.2 of the Code has been supplied to the ship in an approved form.

7 That the ship must be loaded:

.1* only in accordance with loading conditions verified compliant with intact and damage stability requirements using the approved stability instrument fitted in accordance with paragraph 2.3 of the Code;

.2* where a waiver permitted by paragraph 2.4 of the Code is granted and the approved stability instrument required by paragraph 2.3 of the Code is not fitted, loading should be made in accordance with the following approved methods:

(i)* in accordance with the loading conditions provided in the approved loading and stability information booklet referred to in 6 above; or

(ii)* in accordance with loading conditions verified remotely using an approved means.....; or

(iii)* in accordance with a loading condition which lies within an approved range of conditions defined in the approved loading and stability information booklet referred to in 6 above; or

(iv)* in accordance with a loading condition verified using approved critical KG/GM data defined in the approved loading and stability information booklet referred to in 6 above; and

.3* in accordance with the loading limitations appended to this Certificate.

Where it is required to load the ship other than in accordance with the above instruction, then the necessary calculations to justify the proposed loading conditions should be communicated to the certifying Administration who may authorize in writing the adoption of the proposed loading condition.**

* Delete as appropriate.

** Instead of being incorporated in the Certificate, this text may be appended to the Certificate, if duly signed and stamped."

ANNEX 16

DRAFT MSC RESOLUTION

**AMENDMENTS TO THE INTERNATIONAL CODE ON THE ENHANCED PROGRAMME
OF INSPECTIONS DURING SURVEYS OF BULK CARRIERS
AND OIL TANKERS, 2011 (2011 ESP CODE)**

THE MARITIME SAFETY COMMITTEE,

RECALLING Article 28(b) of the Convention on the International Maritime Organization concerning the functions of the Committee,

NOTING resolution A.1049(27), by which the Assembly adopted the International Code on the Enhanced Programme of Inspections during Surveys of Bulk Carriers and Oil Tankers, 2011 ("the 2011 ESP Code"), which has become mandatory under chapter XI-1 of the International Convention for the Safety of Life at Sea, 1974, as amended ("the Convention"),

NOTING ALSO article VIII(b) and regulation XI-1/2 of the Convention concerning the procedure for amending the 2011 ESP Code,

HAVING CONSIDERED, at its [one-hundredth] session, amendments to the 2011 ESP Code proposed and circulated in accordance with article VIII(b)(i) of the Convention,

1 ADOPTS, in accordance with article VIII(b)(iv) of the Convention, amendments to the 2011 ESP Code, as amended by resolutions MSC.371(93), MSC.381(94), MSC.405(96) and MSC.412(97), the text of which is set out in the annex to the present resolution;

2 DETERMINES, in accordance with article VIII(b)(vi)(2)(bb) of the Convention, that the said amendments shall be deemed to have been accepted on [1 January 2020] unless, prior to that date, more than one third of the Contracting Governments to the Convention or Contracting Governments the combined merchant fleets of which constitute not less than 50% of the gross tonnage of the world's merchant fleet, have notified the Secretary-General of their objections to the amendments;

3 INVITES Contracting Governments to the Convention to note that, in accordance with article VIII(b)(vii)(2) of the Convention, the amendments shall enter into force on [1 July 2020] upon their acceptance in accordance with paragraph 2 above;

4 REQUESTS the Secretary-General, for the purposes of article VIII(b)(v) of the Convention, to transmit certified copies of the present resolution and the text of the amendments contained in the annex to all Contracting Governments to the Convention;

5 REQUESTS ALSO the Secretary-General to transmit copies of this resolution and its annex to Members of the Organization which are not Contracting Governments to the Convention.

ANNEX

**AMENDMENTS TO THE INTERNATIONAL CODE ON THE ENHANCED
PROGRAMME OF INSPECTIONS DURING SURVEYS OF BULK
CARRIERS AND OIL TANKERS, 2011 (2011 ESP CODE),
AS AMENDED**

**INTERNATIONAL CODE ON THE ENHANCED PROGRAMME OF INSPECTIONS
DURING SURVEYS OF BULK CARRIERS AND OIL TANKERS, 2011
(2011 ESP CODE)**

ANNEX A

**CODE ON THE ENHANCED PROGRAMME OF INSPECTIONS
DURING SURVEYS OF BULK CARRIERS**

Part A

**CODE ON THE ENHANCED PROGRAMME OF INSPECTIONS
DURING SURVEYS OF BULK CARRIERS HAVING
SINGLE-SIDE SKIN CONSTRUCTION**

1 General

- 1 In paragraphs 1.1.1 to 1.1.3, the word "should" is replaced with the words "is to".
- 2 In paragraphs 1.1.4, 1.1.5 and 1.1.7, the word "should" is replaced with the words "are to".
- 3 In paragraph 1.2.2, the existing definition of the term "*Ballast tank*" is amended by inserting the word "solely" between the words "is used" and "for salt water ballast".
- 4 In paragraph 1.2.7, the word "should" is replaced with the words "is to".
- 5 In paragraph 1.2.10, the words "should usually" are replaced with the words "is usually to".
- 6 In the paragraph 1.2.18, the reference to "figure 2 of annex 15" is replaced with the reference to "figure 1".
- 7 The following new paragraphs 1.2.19 and 1.2.20, and figures 1 to 3 are inserted after the existing paragraph 1.2.18:

"1.2.19 *Edge corrosion* is defined as local material loss at the free edges of plates, stiffeners, primary support members and around openings. An example of edge corrosion is shown in figure 2.

1.2.20 *Grooving corrosion* is typically local material loss adjacent to weld joints along abutting stiffeners and at stiffener or plate butts or seams. An example of groove corrosion is shown in figure 3.

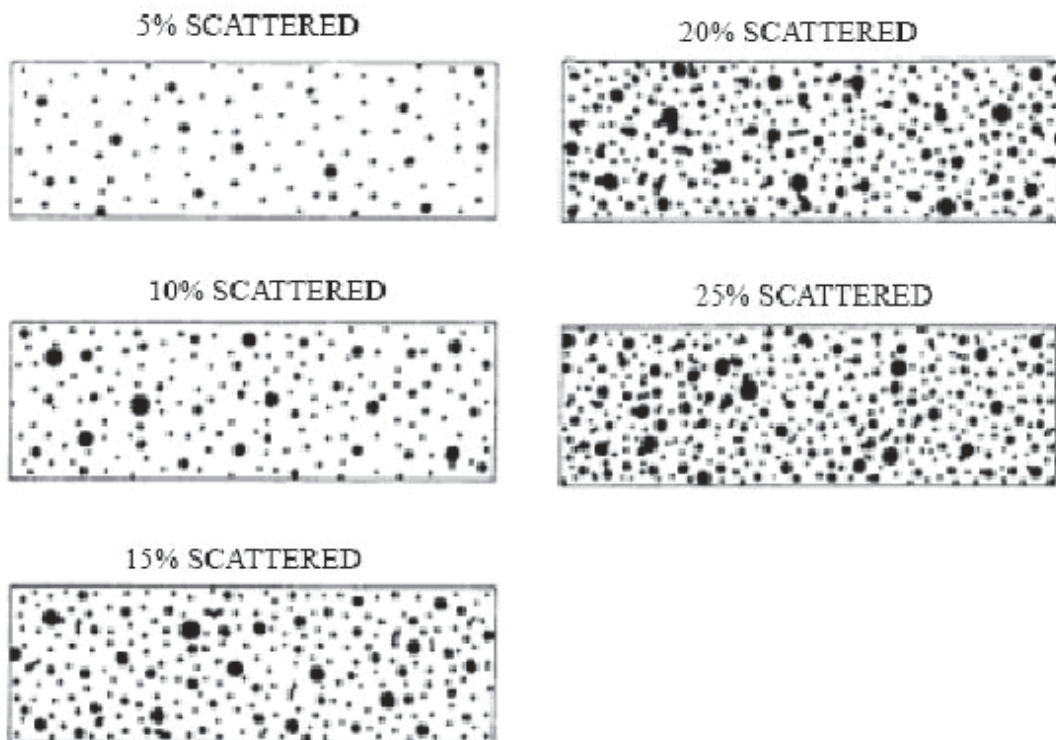

Figure 1: Pitting intensity diagrams

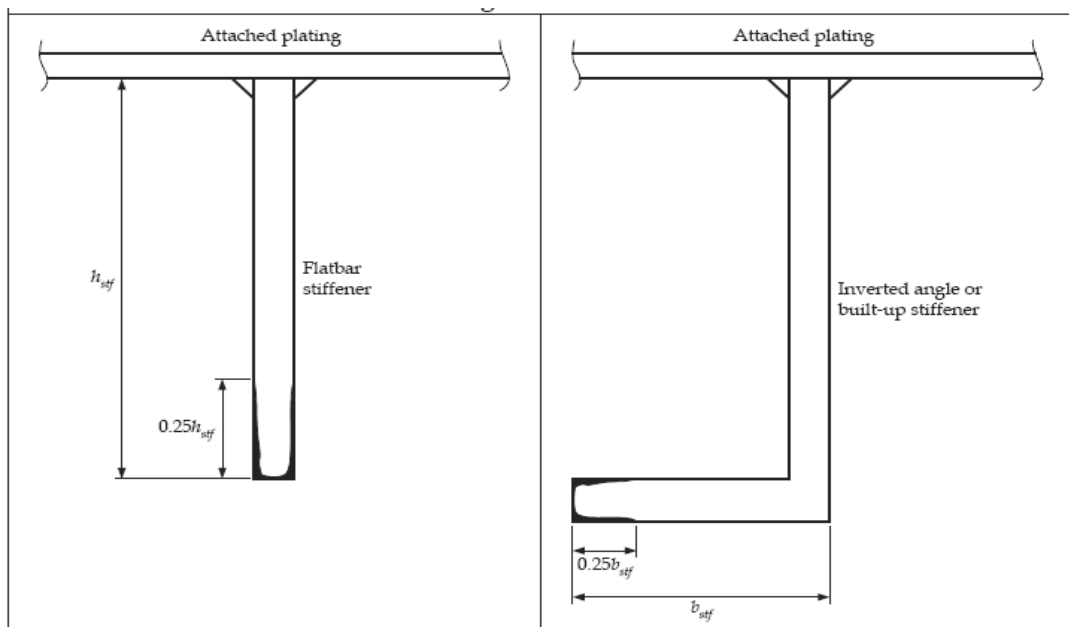

Figure 2: Edge corrosion

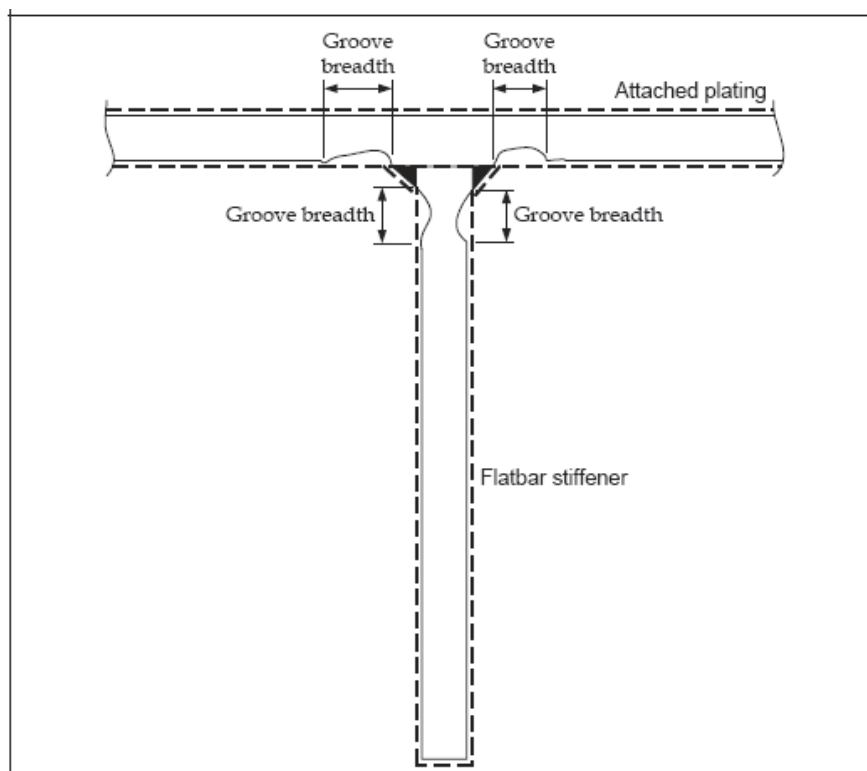

Figure 3: Grooving corrosion".

8 In paragraph 1.3.1, the word "should" is replaced with the words "is to".

9 In paragraph 1.3.2, the word "should" is replaced with the words "are to".

10 The existing text of section 1.4 is replaced with the following:

1.4.1 On bulk carriers of 20,000 tonnes deadweight (DWT) and above starting with renewal survey No.3, at renewal and intermediate hull surveys, the survey of hull structure and piping systems to which this Code applies is to be carried out by at least two exclusive surveyors of a recognized organization. On bulk carriers of 100,000 DWT and above of single side skin construction at the intermediate hull survey between 10 and 15 years of age, the survey of hull structure and piping systems to which this Code applies is to be performed by at least two exclusive surveyors.

1.4.2 This requires that at least two exclusive surveyors attend on board at the same time to perform the required survey. Though each attending surveyor is not required to perform all aspects of the required survey, they are required to consult with each other and to do joint overall and close-up surveys to the extent necessary to determine the condition of the vessel areas to which this Code applies. The extent of these surveys should be sufficient for the surveyors to agree on actions required to complete the survey with respect to renewals, repairs, and other recommendations or conditions of class. Each surveyor is required to co-sign the survey report or indicate their concurrence in an equivalent manner.

1.4.3 The following surveys may be witnessed by a single surveyor:

- .1 thickness measurements;

.2 tank testing; and

.3 repairs carried out in association with intermediate and renewal hull surveys, the extent of which have been agreed upon by the required two surveyors during the course of the surveys."

11 In section 1.5, the word "should" is replaced with the words "are to".

2 Renewal survey

12 In paragraph 2.1.2, the word "should" is replaced with the words "is to", and the words "should not" are replaced with the words "is not to".

13 In paragraph 2.1.3, the word "should" is replaced with the words "is to".

14 In paragraph 2.1.4, in the first sentence, the words "should be examined" and "should be supplemented" are replaced with the words "are to be examined" and "is to be supplemented", respectively, and, in the second sentence, the word "should" is replaced with the words "is to".

15 In paragraph 2.1.5, the word "should" is replaced with the words "are to".

16 In paragraph 2.1.6, the word "should" is replaced with the words "is to".

17 In paragraph 2.1.7, the words "should not be" are replaced with the words "are not".

18 In paragraph 2.2.1, in the first sentence, the word "should" is replaced with the words "is to" and, in the second sentence, the word "should" is replaced with the words "are to".

19 In paragraph 2.2.2, in the first sentence, the word "should" is replaced with the words "is to" and, in the third sentence, the words "should only be" are replaced with the words "is only to be".

20 In paragraph 2.2.3, the word "should" is replaced with the words "is to".

21 In paragraph 2.2.4, the word "should" is replaced with the words "are to".

22 In paragraph 2.3.1, in the first and last sentences, the word "should" is replaced with the words "is to" and, in the second and third sentences, the word "should" is replaced with the words "are to".

23 In section 2.4, the word "should" is replaced with the words "are to".

24 In paragraphs 2.4.1 to 2.4.4, the word "should" is replaced with the words "is to".

25 In paragraph 2.5.1, in the first sentence, the word "should" is replaced with the words "is to", in the second sentence, the word "should" is replaced with the words "are to", in notes 2 and 3 of the table, the word "should" is replaced with the words "are to" and, in note 4 of the table, the word "should" is replaced with the words "is to".

26 In paragraph 2.6.2, in the first sentence, the words "should" are replaced with the words "are to" and, in the second sentence, the words "should also" are replaced with the words "is also to".

27 In the second, third and fourth sentences of paragraph 2.6.3 and in paragraph 2.6.6, the word "should" is replaced with the words "are to".

28 In the first and second sentences of paragraph 2.7.1 and in paragraphs 2.7.3 to 2.7.5, the word "should" is replaced with the words "are to".

29 In paragraphs 2.8.1 and 2.8.2, the word "should" is replaced with the words "is to".

3 Annual survey

30 The following new sentence is added in the beginning of the existing text of section 3.1:

"Annual surveys are to be held within three months before or after the anniversary date from the date of the initial survey or of the date credited for the last renewal survey."

and, in the existing text, all words "should" are replaced with the words "is to".

31 In paragraphs 3.2.1 and 3.2.2, the word "should" is replaced with the words "is to".

32 In paragraph 3.3.1, the word "should" is replaced with the words "is to".

33 In paragraph 3.3.2, in the first and last sentences, the word "should" is replaced with the words "is to", in the second sentence, the words "at least" is deleted and, in the second and third sentences, the word "should" is replaced with the words "are to".

34 In paragraph 3.3.3, in the first and second sentences of paragraph 3.3.4, in the chapeau of paragraph 3.3.5, and in paragraph 3.3.6, the word "should" is replaced with the words "are to".

35 In paragraph 3.3.8, in the chapeau, the word "should" is replaced with the words "is to".

36 In paragraphs 3.3.9 and 3.3.10, the word "should" is replaced with the words "are to".

37 In paragraph 3.4.1, in the chapeau, the word "should" is replaced with the words "is to".

38 In paragraph 3.4.1.2, in the first sentence, the words "the side frame at the side shell" are replaced with the words "side frame at side shell" and, in the second sentence, the word "should" is replaced with the words "is to".

39 In paragraph 3.4.1.3, in the first and second sentences, the word "should" is replaced with the words "is to" and, in the third, fourth and fifth sentences, the word "should" is replaced with the words "are to".

40 In paragraph 3.4.1.5, the word "should" is replaced with the words "are to".

41 In paragraph 3.4.2, in the first sentence, the word "should" is replaced with the words "is to".

42 In paragraph 3.4.2.2, in the first sentence, the word "examination" is replaced with the word "survey" and the words "the side frame at the side shell" is replaced with the words "side frame at side shall", and, in the second sentence, the word "should" is replaced with the words "is to" and the words "the cargo" are replaced with "that cargo".

43 In subparagraph 3.4.2.3, in the first and second sentences, the word "should" is replaced with the words "is to" and, in the third, fourth and fifth sentences, the word "should" is replaced with the words "are to".

44 In subparagraph 3.4.2.5, the word "should" is replaced with the words "are to".

45 In section 3.5, in the first, second and third sentences, the word "should" is replaced with the words "is to" and in the fourth, fifth and sixth sentences, the word "should" is replaced with the words "are to".

46 In paragraph 3.6.2, the word "should" is replaced with the words "are to".

47 In paragraph 3.7.1, the word "cargo" is deleted and the word "should" is replaced with the words "are to".

48 In paragraph 3.7.2, the word "should" is replaced with the words "is to".

4 Intermediate survey

49 In paragraph 4.1.3, the words "should not" are replaced with the words "are not to".

50 In the first and second sentences of paragraph 4.2.1.1 and in paragraph 4.2.1.2, the word "should" is replaced with the words "is to".

51 In paragraph 4.2.1.3, in the first and last sentences, the word "should" is replaced with the words "are to".

52 In paragraph 4.2.1.4, the word "renewal" is deleted and the word "should" is replaced with the words "are to".

53 In the chapeau of paragraph 4.2.2.1, and in paragraphs 4.2.2.2 and 4.2.3.1, the word "should" is replaced with the words "is to".

54 In paragraphs 4.3.1 and 4.4.1, the word "should" is replaced with the words "are to".

55 In paragraph 4.4.3, in the first sentence, the word "should" is replaced with the words "is to" and, in the second sentence, the word "should" is replaced with the words "are to".

5 Preparations for survey

56 The existing paragraph 5.1.1 is amended to read as follows:

"5.1.1 The owner in cooperation with the Administration is to work out a specific survey programme prior to the commencement of any part of the renewal survey and, for bulk carriers over 10 years of age, the intermediate survey. The survey programme is to be in a written format based on the information in annex 4A. The survey is to not commence until the survey programme has been agreed."

57 In paragraph 5.1.1.1, the word "should" is replaced with the words "is to".

58 In paragraph 5.1.1.2, in the first sentence, the words "(executive hull summary report)" are inserted after the words "condition evaluation" and, in the second sentence, the word "should" is replaced with the words "is to".

59 In the chapeau of paragraph 5.1.2, the word "should" is replaced with the words "is to".

60 In paragraph 5.2.1.4, the words "classification society" are replaced with the words "recognized organization".

61 In the chapeau of paragraph 5.1.3 and in paragraph 5.2.1, the word "should" is replaced with the words "is to".

62 In paragraphs 5.2.2 and 5.2.3, the word "should" is replaced with the words "are to".

63 In paragraph 5.2.4, the words "should not" are replaced with the words "is not to".

64 In paragraph 5.2.5, in the first and second sentences, the word "should" is replaced with the words "are to" and, in the third sentence, the word "should" is replaced with the words "is to".

65 In paragraph 5.2.6, in the first and second sentences, the word "should" is replaced with the words "are to".

66 In paragraph 5.2.7 and in the first and second sentences of paragraph 5.2.8, the word "should" is replaced with the words "is to".

67 In paragraph 5.2.9, the words "should always" are replaced with the words "is(are) always to".

68 In paragraph 5.3.1, the word "should" is replaced with the words "are to".

69 In paragraphs 5.3.2 and 5.3.3, in the chapeau, the word "should" is replaced with the words "is to".

70 In paragraph 5.3.4, in the chapeau, the words "should not be" are replaced with the words "is not to be" and the words "should be" are replaced with the words "is to be".

71 The following new paragraph 5.3.6 is added after the existing paragraph 5.3.5:

"5.3.6 The use of hydraulic arm vehicles or aerial lifts ("cherry picker") may be accepted by the attending surveyor for the close-up survey of the upper part of side shell frames or other structures in all cases where the maximum working height is not more than 17 m."

72 In paragraph 5.4.1, in the first sentence, the word "should" is replaced with the words "are to" and, in the second sentence, the word "should" is replaced with the words "is to".

73 In paragraph 5.4.3, in the first sentence, the word "should" is replaced with the words "are to" and, in the second sentence, the word "should" is replaced with the words "is to".

74 In paragraphs 5.4.4, 5.4.5 and 5.5, the word "should" is replaced with the words "is to".

75 In paragraph 5.6.1, the word "should" is replaced with the words "are to".

76 In paragraph 5.6.2, in the first sentence, the word "should" is replaced with the words "is to" and, in the second sentence, the words "should also" are replaced with the words "is also to".

77 In paragraph 5.6.3, the words "should only" are replaced with the words "are only to" and the words "should take" are replaced with the words "is to take".

78 In the chapeau of paragraph 5.6.4 and in paragraph 5.6.4.1, the word "should" is replaced with the words "are to".

79 In paragraph 5.6.4.2, the words "should be tethered" are replaced with the words "is to be tethered" and the words "should be stationed" are replaced with the words "is to be stationed".

80 In paragraph 5.6.4.3, the word "should" is replaced with the words "is to".

81 In paragraph 5.6.4.4, in the first sentence, the word "should" is replaced with the words "is to" and the words "should not" are replaced with the words "is not to", and, in the second sentence, the words "should the level of the water be" are replaced with the words "the level of the water is to be".

82 In paragraph 5.6.4.6, in the first sentence, the words "should the water level be" are replaced with the words "is the water level to be" and, in the second sentence, the words "should only be" are replaced with the words "is only to be".

83 In paragraph 5.6.6, in the last sentence, the word "should" is replaced with the words "is to".

84 In paragraph 5.6.6.2.2, in the second sentence, the word "should" is replaced with the word "shall" and, in the last sentence, the word "should" is replaced with the words "is to".

85 In paragraph 5.7.1, the word "should" is replaced with the words "is to".

86 In paragraph 5.7.2, the word "should" is replaced with the words "is to" and the words "company operator (as applicable)" are replaced with the words "firm representative, where involved".

87 In paragraph 5.7.3, in the chapeau, the word "should" is replaced with the words "is to".

88 In paragraph 5.7.3.9 the word "company" is replaced with the word "firm".

6 Documentation on board

89 In paragraph 6.1.1, all words "should" are replaced with the words "is to" and, in the second sentence, the words "(executive hull summary report)" are inserted after the words "condition evaluation report".

90 In paragraph 6.1.2 and in the first and second sentences of paragraph 6.1.3, the word "should" is replaced with the words "is to".

91 In paragraph 6.2.1, in the chapeau, the word "should" is replaced with the words "is to".

92 In paragraph 6.2.1.2, the words "(executive hull summary report)" are inserted after the words "condition evaluation report".

93 In paragraph 6.2.1.3, the words "(annex 8A/annex 8B)" are inserted at the end.

94 In paragraph 6.2.2, the word "should" is replaced with the words "is to".

95 In paragraph 6.3.1, in the chapeau, the word "should" is replaced with the words "is to".

96 In paragraph 6.3.1.5.3, the words "coating or" are deleted.

97 In paragraph 6.3.2, the word "should" is replaced with the words "is to".

98 In paragraphs 6.4.1 and 6.4.2, the word "should" is replaced with the words "is to".

99 The following two new paragraphs 6.4.2.1 and 6.4.2.2 are added after the existing paragraph 6.4.2:

"6.4.2.1 For the SCF stored on board ship, the surveyor is to examine the information on board ship. In cases where any major event, including, but not limited to, substantial repair and conversion, or any modification to the ship structures, the surveyor is to also verify that the updated information is kept on board the ship. If the updating of the SCF on board is not completed at the time of survey, the surveyor records it and requires confirmation at the next periodical survey.

6.4.2.2 For the SCF stored on shore archive, the surveyor is to examine the list of information included on shore archive. In cases where any major event, including, but not limited to, substantial repair and conversion, or any modification to the ship structures, the surveyor is to also verify that the updated information is stored on shore archive by examining the list of information included on shore archive or kept on board the ship. In addition, the surveyor is to confirm that the service contract with the archive centre is valid. If the updating of the SCF Supplement ashore is not completed at the time of survey, the surveyor records it and requires confirmation at the next periodical survey."

100 In paragraph 6.4.3, the word "should" is replaced with the words "is to".

7 Procedures for thickness measurements

101 In paragraph 7.1.1, in the first sentence, the word "should" is replaced with the words "are to" and, in the last sentence, the word "should" is replaced with the words "is to".

102 In paragraph 7.1.2, the words "company should" are replaced with the words "firm is to".

103 In paragraphs 7.1.3 and 7.1.4, the word "should" is replaced with the words "are to".

104 In the title of section 7.2, the word "company" is replaced with the word "firm".

105 In the text of section 7.2, the word "should" is replaced with the words "are to" and the word "company" is replaced with the word "firm".

106 The following new section 7.3 is added after the existing section 7.2:

"7.3 *Number and locations of measurements*

7.3.1 Application

This section only applies to ships built under the IACS Common Structural Rules⁵ (CSR). For ships not built under IACS CSR requirements for number and locations of measurements are according to the Rules of the individual classification society and/or specific IACS URs depending on ship's age and structural elements concerned.

7.3.2 Number of measurements

Considering the extent of thickness measurements according to the different structural elements of the ship and surveys (renewal, intermediate and annual), the locations of the points to be measured are given for the most important items of the structure.

7.3.3 Locations of measurements

7.3.3.1 Table 1 provides explanations and/or interpretations for the application of those requirements indicated in IACS CSR, which refer to both systematic thickness measurements related to the calculation of global hull girder strength and specific measurements connected to close-up surveys.

7.3.3.2 Figures 4 to 9 are provided to facilitate the explanations and/or interpretations given in table 1, to show typical arrangements of single skin bulk carriers.

⁵ IACS Common Structural Rules mean IACS Common Structural Rules for Bulk Carriers (IACS CSR for Bulk carriers) or IACS Common Structural Rules for Bulk Carriers and Oil Tankers (IACS CSR BC&OT).

Table 1 – Interpretations of rule requirements for the locations and number of points to be measured for CSR bulk carriers (single skin)

Item	Interpretation	Figure reference
Selected plates on deck, tank top, bottom, double bottom and wind-and-water area	"Selected" means at least a single point on one out of three plates, to be chosen on representative areas of average corrosion	
All deck, tank top and bottom plates and wind-and-water strakes	At least two points on each plate to be taken either at each 1/4 extremity of plate or at representative areas of average corrosion	
Transverse section	A transverse section includes all longitudinal members such as plating, longitudinals and girders at the deck, side, bottom, inner bottom and hopper side plating, longitudinal bulkhead and bottom plating in top wing tanks	Figure 4
All cargo hold hatch covers and coamings	Including plates and stiffeners	Locations of points are given in figure 5
Transverse section of deck plating outside line of cargo hatch openings	Two single points on each deck plate (to be taken either at each 1/4 extremity of plate or at representative areas of average corrosion) between the ship sides and hatch coamings in the transverse section concerned	
All deck plating and underdeck structure inside line of hatch openings between cargo hold hatches	<p>"All deck plating" means at least two points on each plate to be taken either at each 1/4 extremity of plate or at representative areas of average corrosion</p> <p>"Under deck structure": at each short longitudinal girder: three points for web plating (fwd/middle/aft), single point for face plate, one point for web plating and one point for face plating of transverse beam in way. At each ends of transverse beams, one point for web plating and one point for face plating</p>	<p>Extent of areas is shown in appendix 3 to annex 8B</p> <p>Locations of points are given in figure 9</p>
Selected side shell frames in cargo holds	Includes side shell frame, upper and lower end attachments and adjacent shell plating. 25% of frames: one out of four frames should preferably be chosen throughout the cargo hold length on each side. 50% of frames: one out of two frames should preferably be chosen throughout the cargo hold length on each side. "Selected frames" means at least	<p>Extent of areas is shown in appendix 3 to annex 8B</p> <p>Locations of points are given in figure 6</p>

Item	Interpretation	Figure reference
	three frames on each side of cargo holds	
Transverse bulkheads in cargo holds	Includes bulkhead plating, stiffeners and girders, including internal structure of upper and lower stools, where fitted. Two selected bulkheads: one is to be the bulkhead between the two foremost cargo holds and the second may be chosen in other positions	Areas of measurements are shown in appendix 3 to annex 8B Locations of points are given in figure 7
One transverse bulkhead in each cargo hold	This means that the close-up survey and related thickness measurements are to be performed on one side of the bulkhead; the side is to be chosen based on the outcome of the overall survey of both sides. In the event of doubt, the surveyor may also require (possibly partial) close-up survey on the other side	Areas of measurements are shown in appendix 3 to annex 8B Locations of points are given in figure 7
Transverse bulkheads in one topside, hopper and double bottom ballast tank	Includes bulkhead and stiffening systems The ballast tank is to be chosen based on the history of ballasting among those prone to have the most severe conditions	Locations of points are given in figure 8
Transverse webs in ballast tanks	Includes web plating, face plates, stiffeners and associated plating and longitudinals One of the representative tanks of each type (i.e. topside or hopper or side tank) is to be chosen in the forward part	Areas of measurements are shown in appendix 3 to annex 8B Locations of points are given in figure 6

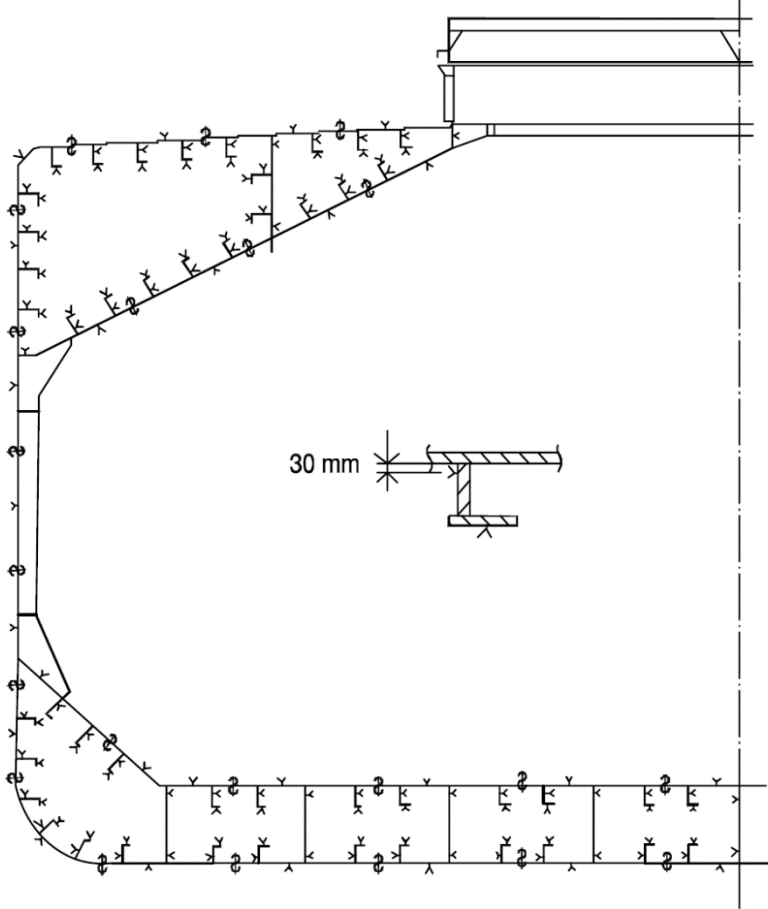

Single side bulk carriers

Note: Measurements are to be taken on both port and starboard sides of the selected transverse section.

Figure 4: Transverse section of a single side skin bulk carrier

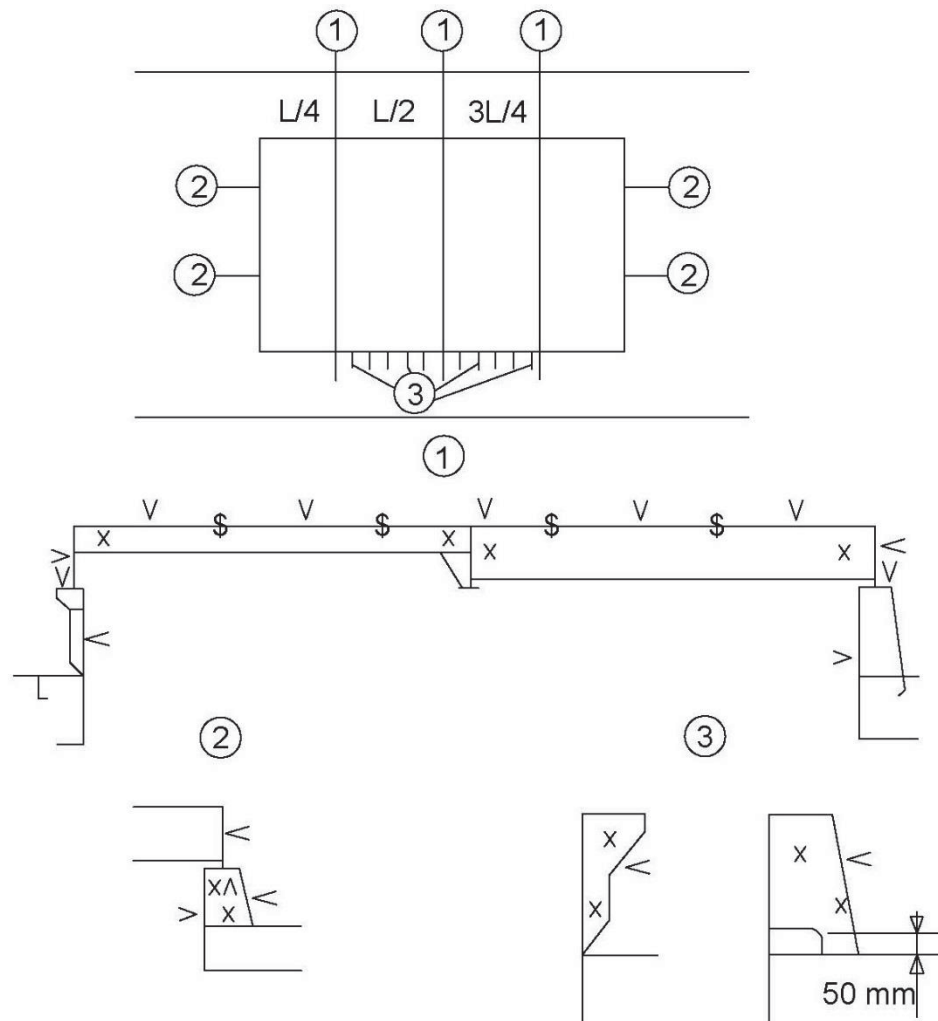

Notes:

- 1 Three sections at $L/4$, $L/2$, $3L/4$ of hatch cover length, including:
 - .1 one measurement of each hatch cover plate and skirt plate;
 - .2 measurements of adjacent beams and stiffeners; and
 - .3 one measurement of coaming plates and coaming flange, each side.
- 2 Measurements of both ends of hatch cover skirt plate, coaming plate and coaming flange.
- 3 One measurement (two points for web plate and one point for face plate) of one out of three hatch coaming brackets and bars, on both sides and both ends.

Figure 5: Locations of measurements on hatch covers and coamings

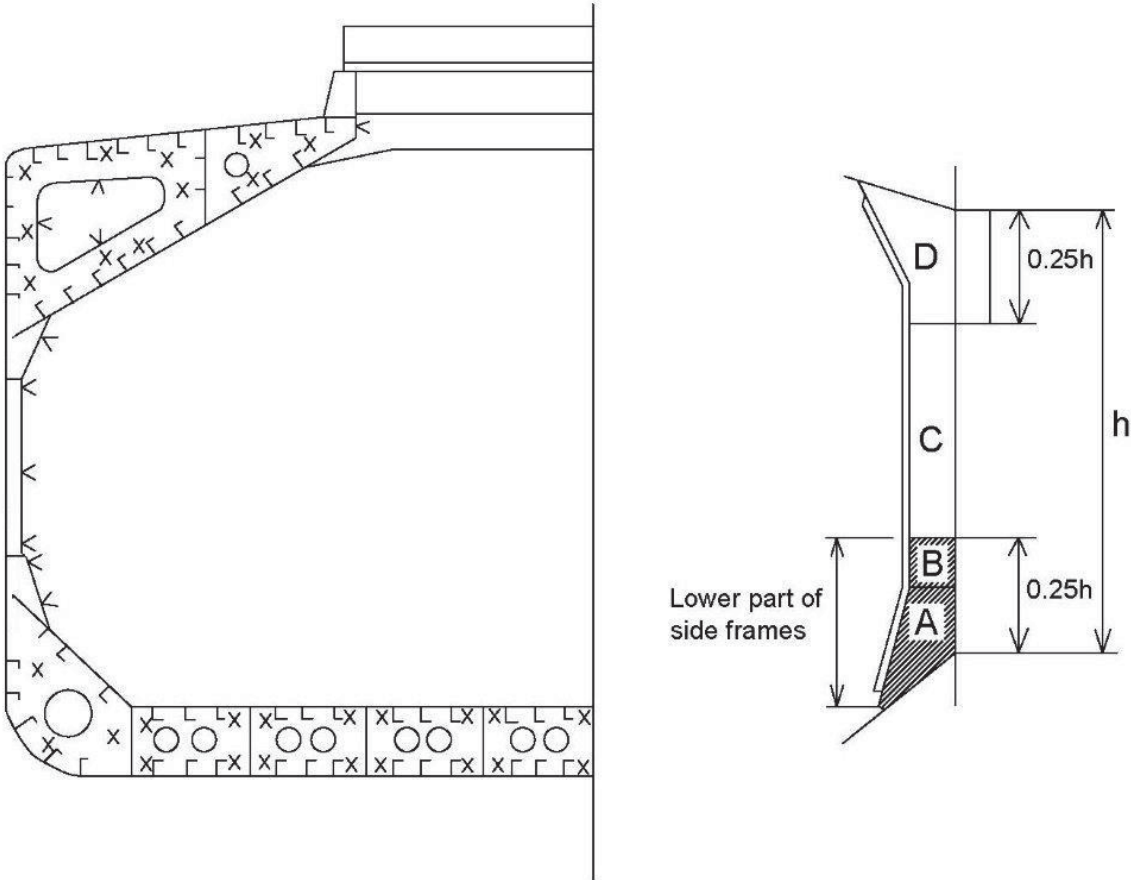

Note: The gauging pattern for web plating is to be a three point pattern for zones A, C and D, and a two point pattern for zone B (see figure). The gauging report is to reflect the average reading. The average reading is to be compared with the allowable thickness. If the web plating has general corrosion then this pattern is to be expanded to a five-point pattern.

Figure 6: Locations of measurements on structural members in cargo holds and ballast tanks of single side skin bulk carriers

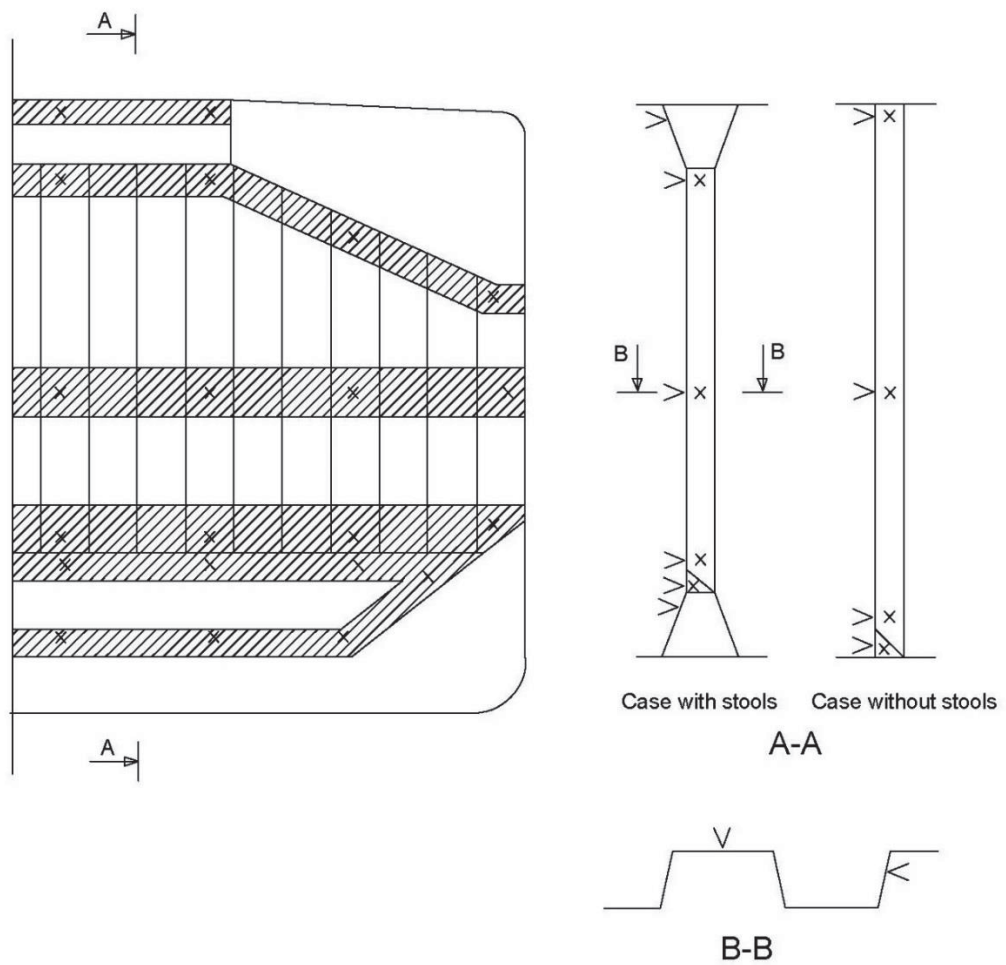

Note: Measurements to be taken in each shaded area as per views A-A and B-B

Figure 7: Locations of measurements on cargo hold transverse bulkheads (additional measurements to internal structure of upper and lower stools to be added, e. g. two points in the upper and two points in the lower stools to be indicated in section A–A)

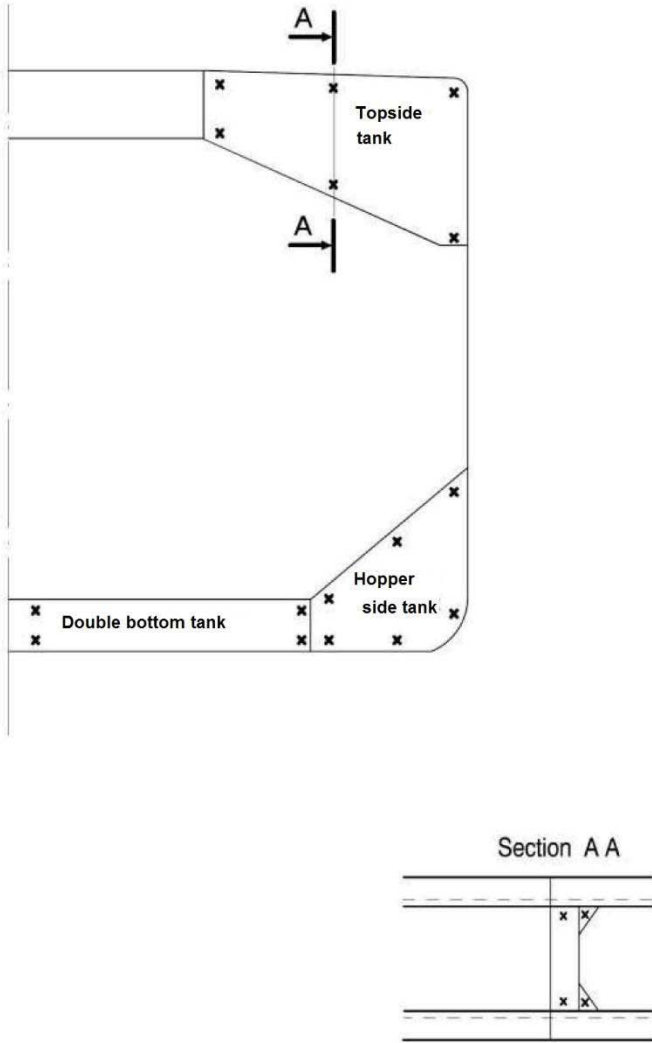

Note: Measurements to be taken in each vertical section as per view A–A

Figure 8: Locations of measurements on transverse bulkheads of topside, hopper and double bottom tanks (two additional measurements to internal structure of double bottom tank to be added at midspan)

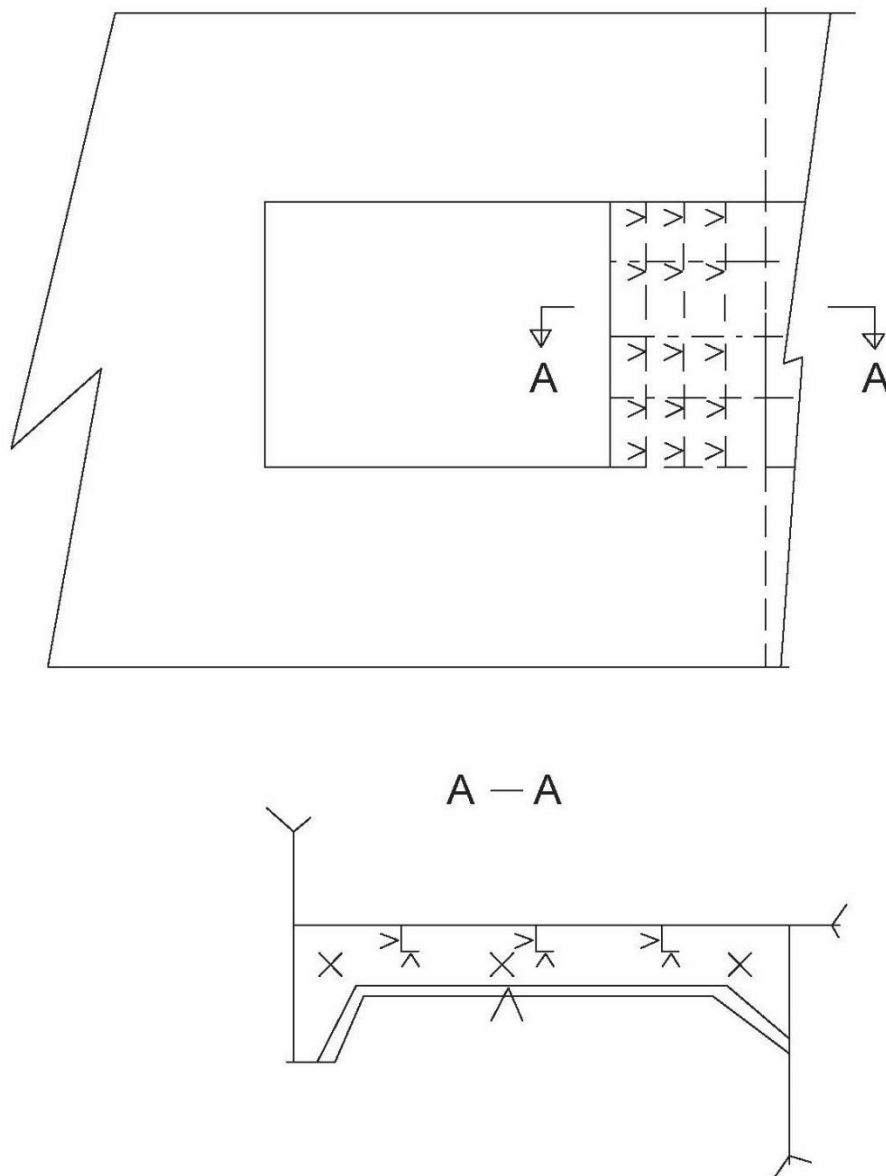

Figure 9: Locations of measurements on underdeck structure".

107 The existing section 7.3 is renumbered accordingly.

108 In the renumbered paragraph 7.4.1, all words "should" are replaced with the words "is to" and the reference to "annex 8" are replaced with the reference to "annex 8a/annex 8B".

109 In the renumbered paragraph 7.4.2, the word "should" is replaced with the words "is to".

110 The following new section 8 is inserted after the renumbered section 7.4:

"8 Acceptance criteria

8.1 *General*

8.1.1 For ships built under IACS CSR, the acceptance criteria are specified in sections 8.2, 8.3 and 8.4.

8.1.2 For ships not built under IACS CSR, the acceptance criteria are to be taken in accordance with the Rules of the individual classification society and/or specific IACS URs depending on ship's age and structural elements concerned, e.g. UR S18 for corrugated transverse watertight bulkheads, UR S19 for the transverse watertight corrugated bulkhead between cargo holds Nos. 1 and 2, UR S21 for all cargo hatch covers and hatch forward and side coamings on exposed decks in position 1 (as defined in the International Convention on Load Lines, 1966), UR S31 for side shell frames, as applicable.

8.2 *Acceptance criteria for pitting corrosion for ships built under IACS CSR*

8.2.1 Side structures

8.2.1.1 If pitting intensity in an area where coating is required, according to IACS CSR, as applicable, is higher than 15% (see figure 1 above), thickness measurements are to be performed to check the extent of pitting corrosion. The 15% is based on pitting or grooving on only one side of a plate.

8.2.1.2 In cases where pitting is exceeding 15%, as defined above, an area of 300 mm or more, at the most pitted part of the plate, is to be cleaned to bare metal and the thickness is to be measured in way of the five deepest pits within the cleaned area. The least thickness measured in way of any of these pits is to be taken as the thickness to be recorded.

8.2.1.3 The minimum remaining thickness in pits, grooves or other local areas is to be greater than the following without being greater than the renewal thickness (t_{ren}):

- .1 75% of the as-built thickness, in the frame and end brackets webs and flanges; and
- .2 70% of the as-built thickness, in the side shell, hopper tank and topside tank plating attached to the each side frame, over a width up to 30 mm from each side of it.

8.2.2 Other structures

For plates with pitting intensity less than 20%, see figure 1 above, the measured thickness, t_m of any individual measurement is to meet the lesser of the following criteria:

$$t_m \geq 0.7 (t_{as-built} - t_{vol add}) \text{ (mm); and}$$

$$t_m \geq t_{ren} - 1 \text{ (mm),}$$

where:

$t_{\text{as-built}}$	as-built thickness of the structural member, in mm;
$t_{\text{vol add}}$	voluntary thickness addition; thickness, in mm, voluntarily added as the owner's extra margin for corrosion wastage in addition to t_c ;
t_{ren}	renewal thickness; minimum allowable thickness, in mm, below which renewal of structural members is to be carried out;
t_c	total corrosion addition, in mm, defined in IACS CSR ⁶ , as applicable; and
t_m	measured thickness, in mm, on one item, i.e. average thickness on one item using the various measurements taken on this same item during periodical ship's in service surveys.

The average thickness across any cross section in the plating is not to be less than the renewal criteria for general corrosion given in IACS CSR,⁷ as applicable.

8.3 Acceptance criteria for edge corrosion for ships built under IACS CSR

8.3.1 Provided that the overall corroded height of the edge corrosion of the flange, or web in the case of flat bar stiffeners, is less than 25%, see figure 2 above, of the stiffener flange breadth or web height, as applicable, the measured thickness, t_m , is to meet the lesser of the following criteria:

$$t_m \geq 0.7 (t_{\text{as-built}} - t_{\text{vol add}}) \text{ (mm); and}$$

$$t_m \geq t_{\text{ren}} - 1 \text{ (mm)}.$$

8.3.2 The average measured thickness across the breadth or height of the stiffener is not to be less than that defined in IACS CSR, as applicable.

8.3.3 Plate edges at openings for manholes, lightening holes etc. may be below the minimum thickness given in IACS CSR, as applicable, provided that:

- .1 the maximum extent of the reduced plate thickness, from the opening edge, below the minimum, is not more than 20% of the smallest dimension of the opening and does not exceed 100 mm; and
- .2 rough or uneven edges may be cropped-back provided that the maximum dimension of the opening is not increased by more than 10% and the remaining thickness of the new edge is not less than $t_{\text{ren}} - 1$ mm.

⁶ Section 3 of Chapter 5 of IACS CSR for Bulk Carriers or Section 4 of Chapter 3 of Part 1 of IACS CSR BC & OT.

⁷ Section 3 of Chapter 3 of IACS CSR for Bulk Carriers or Section 3 of Chapter 3 of Part 1 of IACS CSR BC & OT.

8.4 *Acceptance criteria for grooving corrosion for ships built under IACS CSR*

8.4.1 Where the groove breadth is a maximum of 15% of the web height, but not more than 30 mm, see figure 3 above, the measured thickness, t_m , in the grooved area is to meet the lesser of the following criteria:

$$t_m \geq 0.75 (t_{as-built} - t_{vol add}) \text{ (mm);}$$

$$t_m \geq t_{ren} - 0.5 \text{ (mm); and}$$

$$t_m \geq 6 \text{ mm.}$$

8.4.2 Structural members with areas of grooving greater than those in 8.4.1 above are to be assessed based on the criteria for general corrosion as defined in IACS CSR, as applicable, using the average measured thickness across the plating/stiffener."

8 Reporting and evaluation of survey

111 The existing section 8 is renumbered accordingly.

112 In the renumbered paragraph 9.1.1, the word "should" is replaced with the words "are to".

113 The following two new paragraphs 9.1.1.1 and 9.1.1.2 are inserted after the renumbered paragraph 9.1.1:

9.1.1.1 For bulk carriers built under IACS CSR, the ship's longitudinal strength is to be evaluated by using the thickness of structural members measured, renewed and reinforced, as appropriate, during the renewal surveys carried out after the ship reached 15 years of age (or during the special survey No. 3, if this is carried out before the ship reaches 15 years) in accordance with the criteria for longitudinal strength of the ship's hull girder for bulk carriers, specified in IACS CSR.

9.1.1.2 The final result of evaluation of the ship's longitudinal strength required in paragraph 9.1.1.1, after renewal or reinforcement work of structural members, if carried out as a result of initial evaluation, is to be reported as a part of the condition evaluation report (executive hull summary report)."

114 In the renumbered paragraph 9.1.2, the words "should be carried out" are replaced with the words "is to be carried out", the words "should be made available" are replaced with the words "is to be made available" and the words "(executive hull summary report)" are inserted after the words "condition evaluation report".

115 In the renumbered paragraph 9.2.2, in the first and second sentences, the word "should" is replaced with the words "is to".

116 In the renumbered paragraph 9.2.3, in the first sentence, the words "(executive hull summary report)" are inserted after the words "condition evaluation report" and the word "should" is replaced with the words "are to", and, in the last sentence, the words "(executive hull summary report)" are inserted after the words "condition evaluation report" and the word "should" is replaced with the words "is to".

ANNEX 1

REQUIREMENTS FOR CLOSE-UP SURVEY AT RENEWAL SURVEYS

117 The existing title of the table is amended to read "**MINIMUM REQUIREMENTS FOR CLOSE-UP SURVEY AT RENEWAL HULL SURVEY OF SINGLE SIDE SKIN BULK CARRIERS**".

118 In the table, in the column "Renewal Survey No.4 and subsequent", the words "column 3" are replaced with the words "renewal survey No.3".

119 Under the table, in reference (E), the words "and underdeck structure" are inserted after the words "Deck plating" and the words "appendix 3" is replaced with the words "appendices 3 to annexes 8A and 8B".

ANNEX 2

REQUIREMENTS FOR THICKNESS MEASUREMENTS AT RENEWAL SURVEYS

120 The existing title of the table is amended to read "**MINIMUM REQUIREMENTS FOR THICKNESS MEASUREMENTS AT RENEWAL HULL SURVEY OF SINGLE SKIN BULK CARRIERS**".

121 In the table, in the column "Renewal Survey No.3", in subparagraph 2.2 the word "should" is replaced with the words "are to", the following new subparagraph 2.3 is inserted after the existing subparagraph 2.2:

"2.3 all wind and water strakes within the cargo length area",

paragraph 4 is deleted and the remaining paragraphs are renumbered accordingly.

122 In the table, in the column "Renewal Survey No.4", in subparagraph 2.2, the word "should" is replaced with the words "are to".

ANNEX 3

OWNER'S INSPECTION REPORT

123 The existing form is replaced with the following new form:

"Structural condition"

Name of ship:
IMO number:
Port of registry:
Owner:

TANK/HOLD	Grade of steel	Cracks	Corrosion	Buckles	Coating condition	Pitting	Modification/repair	Other
TANK/HOLD No.....								
Deck								
Bottom								
Side								
Side framing								
Longitudinal bulkheads								
Transverse bulkheads								
Repairs carried out due to: Thickness measurements carried out (dates): Results in general: Overdue surveys: Outstanding conditions of class: Comments:								

Inspected by			
	<i>Name</i>	<i>Date of inspection</i>	<i>Signature"</i>

ANNEX 4A

SURVEY PROGRAMME

Basic information and particulars

124 In the table, in the last row replace the word "company" with the word "firm".

1 Preamble

125 In paragraphs 1.1.2 and 1.2, the word "should" is replaced with the words "are to".

2 Arrangement of cargo holds, tanks and spaces

126 In section 2, the word "should" is replaced with the words "is to".

3 List of cargo holds, tanks and spaces with information on their use, extent of coatings and corrosion prevention system

127 In section 3, the words "should indicate" are replaced with the words "is to indicate" and the words "should update" are replaced with the words "is to update".

4 Conditions for survey

128 In section 4, the word "should" is replaced with the words "is to".

5 Provisions and method of access to structures

129 In section 5, the words "should indicate" are replaced with the words "is to indicate" and the words "should update" are replaced with the words "is to update".

6 List of equipment for survey

130 In section 6, the word "should" is replaced with the words "is to".

7 Survey requirements

131 In paragraphs 7.1 and 7.2, the words "should identify" are replaced with the words "is to identify" and the words "should undergo" are replaced with the words "are to undergo".

8 Identification of tanks for tank testing

132 In section 8, the words "should identify" are replaced with the words "is to identify" and the words "should undergo" are replaced with the words "are to undergo".

9 Identification of areas and sections for thickness measurements

133 In section 9, the words "should identify" are replaced with the words "is to identify" and the words "should be taken" are replaced with the words "are to be taken".

10 Minimum thickness of hull structures

134 In the chapeau of section 10, the word "should" is replaced with the words "is to" and the words ",according to (a) or (b)" are replaced with the words "(indicate either (a) or preferably (b) if such information is available)".

135 In section 10, in the table, insert a missing 'area' row "**Hatch covers**" between the existing 'location' rows "Stiffeners" and "Plating".

136 In section 10, under the table, in the note, the word "should" is replaced with the words "is to" and the following new sentence is added after the existing note:

"For vessels built under IACS CSR, the renewal thickness of the hull structure elements is indicated in the appropriate drawings."

11 Thickness measurement company

137 In section 11, in the title, the word "company" is replaced with the word "firm" and, in the existing text, the word "should" is replaced with the words "is to" and the word "company" is replaced with the word "firm".

12 Damage experience related to the ship

138 In section 12, the word "should" is replaced with the words "is to".

13 Areas identified with substantial corrosion from previous surveys

139 In section 13, the word "should" is replaced with the words "is to".

14 Critical structural areas and suspect areas

140 In section 14, the word "should" is replaced with the words "is to".

15 Other relevant comments and information

141 In section 15, the word "should" is replaced with the words "is to".

Appendices

142 In the first and second sentences of appendix 1, and in appendices 2 and 3, the word "should" is replaced with the words "is to".

ANNEX 4B

SURVEY PLANNING QUESTIONNAIRE

143 In paragraph 1, the paragraph number is deleted, the word "should" is replaced with the words "is to", the existing subtitles "**Particulars**", "**Information on access provision for close-up surveys and thickness measurement**" and "**Owner's inspection**" are amended to read "**1 Particulars**", "**2 Information on access provision for close-up surveys and thickness measurement**" and "**3 Owner's inspection**", respectively.

144 In paragraph 2, the paragraph number is deleted and the word "should" is replaced with the words "is to" and, in the table, a new column "Permanent means of access" is inserted between the existing columns "Structure" and "Temporary staging".

145 In section 3, in the first sentence, the word "should" is replaced with the words "is to"; in the table, the existing row "Double side skin tanks" is deleted; in note 4), the word "should" is replaced with the words "is to"; and the existing subtitle "**Name and address of the approved thickness measurement company**" is amended to read "**Name and address of the approved thickness measurement firm**".

ANNEX 5

PROCEDURES FOR CERTIFICATION OF A COMPANY ENGAGED IN THICKNESS MEASUREMENT OF HULL STRUCTURES

146 In the existing title of annex 5, the words "**APPROVAL AND**" are inserted before the word "**CERTIFICATION**" and the word "**COMPANY**" is replaced with the word "**FIRM**".

1 Application

147 In section 1, the word "company" is replaced with the word "firm".

2 Procedures for certification

148 In the existing title of section 2, the words "**approval and**" are inserted before the word "**certification**".

149 In paragraph 2.1, in the chapeau, the word "should" is replaced with the words "are to".

150 In paragraphs 2.1.1 and 2.1.2, the word "company" is replaced with the word "firm".

151 In paragraph 2.1.3, the word "should" is replaced with the words "are to".

152 In paragraph 2.1.7, the reference to "annex 8" are replaced with the reference to "annex 8A/annex 8B".

153 The existing subtitle "*Auditing of the company*" is amended to read "*Auditing of the firm*".

154 In paragraph 2.2, the words "company should be audited" are replaced with the words "firm is to be audited" and the words "company is duly organized" is replaced with the words "firm is duly organized".

3 Certification

155 In paragraph 3.1, the words "audit of the company" are replaced with the words "audit of the firm", the word "should" is replaced with the words "is to" and words "system of the company" are replaced with the words "system of the firm".

156 In paragraph 3.2, the word "should" is replaced with the words "is to".

4 Report of any alteration to the certified thickness measurement operation system

157 In section 4, in the title, the words "**Report of**" are replaced with the words "**Information about**" and, in the first sentence, the words "company", "should" and "reported" are replaced with the words "firm", "is to" and "informed", respectively, and, in the second sentence, the word "should" is replaced with the words "is to".

5 Withdrawal of the certification

158 In section 5, in the title, the words "**Withdrawal of the certification**" are replaced with the words "**Cancellation of approval**" and the existing chapeau is amended to read "Approval may be cancelled and the certification withdrawn in the following cases:".

159 In paragraph 5.2, the word "company" is replaced with the word "firm".

160 In paragraph 5.3, the words "company" and "report" are replaced with the words "firm" and "informed of", respectively.

ANNEX 6

SURVEY REPORTING PRINCIPLES

161 The introductory paragraph of annex 6 is amended to read as follows:

"As a principle, for bulk carriers subject to this Code, the surveyor(s) are to include the following contents in the report for survey of hull structure and piping systems, as relevant for the survey. The structure of the reporting content may be different, depending on the report system of the Administration or by the recognized organization acting on behalf of the Administration."

1 General

162 In paragraphs 1.1 and 1.2, in the chapeau, the word "should" is replaced with the words "is to".

163 In the first and second sentences of paragraph 1.2.3, the word "should" is replaced with the words "are to".

164 In paragraph 1.3, the word "should" is replaced with the words "is to".

2 Extent of the survey

165 In paragraph 2.3, in the text of the note and in the last sentence, the word "should" is replaced with the words "is to".

166 In paragraph 2.4, the word "should" is replaced with the words "are to".

3 Result of the survey

167 In paragraph 3.1, the words "including identification of tanks fitted with anodes" are deleted.

168 In paragraph 3.2.3, the word "should" is replaced with the words "is to".

4 Actions taken with respect to findings

169 In paragraph 4.1, in the first and second sentences, the words "should" and "numbered list" are replaced with the words "is to" and "survey report", respectively, and, in the second sentence, the words "should" and "numbered list" are replaced with the words "are to" and "survey report", respectively.

170 In the existing chapeau of paragraph 4.2, the word "should" is replaced with the words "are to".

171 In paragraph 4.3, in the first and second sentences, the word "should" is replaced with the words "is to" and, in the last sentence, the word "made" is replaced with the word "given".

ANNEX 7

CONDITION EVALUATION REPORT

172 In the title of annex 7, the words "**(EXECUTIVE HULL SUMMARY REPORT)**" are added after the word "**REPORT**".

General particulars

173 The entries "Previous Administration/recognized organization identity number(s):", "Previous national flag(s):", "Owner:" and "Previous owner(s):" are deleted.

174 In the existing table under paragraph 3, in the first and third rows of the first column, the words "(executive hull summary report)" are inserted after the words "Condition evaluation report".

Contents of condition evaluation report

175 The existing subtitle is amended to read "**Contents of condition evaluation report (executive hull summary report)**".

176 In part 4 (Thickness measurements), in the third bullet point, the word "/areas" is inserted after the word "spaces".

177 The existing title of part 7 is amended to read "Condition of class (recommendations)/ flag State requirements:".

Extract of thickness measurements

178 The existing subtitle is amended to read "**Extract of thickness measurements for ships not built under IACS CSR**".

179 In note 3, the word "should" is replaced with the words "is to".

180 The following new section "Extract of thickness measurements for ships built under IACS CSR" is inserted between the existing sections "Extract of thickness measurements" and "Tank/hold corrosion prevention system":

"Extract of thickness measurements for ships built under IACS CSR"

Reference is made to the thickness measurements report:

Position of substantially corroded tanks/areas¹ or areas with deep pitting	$t_m - t_{ren}$ (mm)	Corrosion pattern²	Remarks (e.g. reference to attached sketches)

Notes:

- 1 Substantial corrosion, an extent of corrosion such that the assessment of the corrosion pattern indicates a measured thickness between $t_{ren} + 0.5$ mm and t_{ren} .

- 2 P = Pitting
 C = Corrosion in general
 Areas with deep pitting assessed according to section 8.2 are to be recorded
 in this column."

Tank/hold corrosion prevention system

181 In note 1, the word "should" is replaced with the words "are to".

182 In the last paragraph of note 3, in the first sentence, the word "should" is replaced with the words "are to", and, in the second sentence, the word "should" is replaced with the words "is to" and the words "(executive hull summary report)" are added after the words "condition evaluation report".

ANNEX 8

RECOMMENDED PROCEDURES FOR THICKNESS MEASUREMENTS

183 The existing annex 8 is renumbered as annex 8A.

184 The title for the renumbered annex 8A is amended to read "**RECOMMENDED PROCEDURES FOR THICKNESS MEASUREMENTS OF SINGLE SIDE SKIN BULK CARRIERS NOT BUILT UNDER IACS CSR**".

185 The following new footnote is added to the title of the renumbered annex 8A:

"* This annex is recommendatory."

Appendix 1

GENERAL PARTICULARS

186 In the form, all words "company" are replaced with the word "firm".

Appendix 2

REPORTS ON THICKNESS MEASUREMENT

Reports on thickness measurement of all deck plating, all bottom shell plating or side shell plating (TM1-BC)

187 In the reporting form, the existing report number "(TM1-BC)" is deleted from the title and reproduced, without parenthesis, in the left top corner of the form; the following footnote is added to the title:

"* Delete as appropriate.";

and the symbol "%" is added at the end of the existing heading of the column "Mean diminution".

Report on thickness measurement of shell and deck plating (one, two or three transverse sections) (TM2-BC(i))

188 In the reporting form, the existing title and table are amended to read as follows:

189 In note 1 to report TM2-BC(i), the words "of the" are inserted between the words "comprising" and "structural".

190 In note 2 to report TM2-BC(i), the word "strakes" is inserted between the words "plating" and "outside".

Report on thickness measurement of shell and deck plating (one, two or three transverse sections) (TM2-BC(ii))

191 In the reporting form, the existing title and table are amended to read as follows:

"TM2-BC(ii)

Report on thickness measurement of shell and deck plating (one, two or three transverse sections)

Ship's name..... IMO number..... Class identity No..... Report No.....

SHELL PLATING																													
STRAKE POSITION	FIRST TRANSVERSE SECTION AT FRAME NUMBER								SECOND TRANSVERSE SECTION AT FRAME NUMBER								THIRD TRANSVERSE SECTION AT FRAME NUMBER												
	No. or letter	Org. thk.	Max. alwb. dim.	Gauged		Diminution P		Diminution S		No. or letter	Org. thk.	Max. alwb. dim.	Gauged		Diminution P		Diminution S		No. or letter	Org. thk.	Max. alwb. dim.	Gauged		Diminution P		Diminution S			
				P	S	mm	%	mm	%				P	S	mm	%	mm	%				P	S	mm	%	mm	%		
1st below shear strake																													
2nd																													
3rd																													
4th																													
5th																													
6th																													
7th																													
8th																													
9th																													
10th																													
11th																													
12th																													
13th																													
14th																													
15th																													
16th																													
17th																													
18th																													
19th																													
20th																													
keel strake																													
BOTTOM TOTAL																													

Operator's signature.....

Notes – see following page".

192 In note 1 to report TM2-BC(ii), the words "of the" are inserted between the words "comprising" and "structural".

**Report on thickness measurement of longitudinal members
(one, two or three transverse sections) (TM3-BC)**

193 In the reporting form, the existing title and table are amended to read as follows:

"TM3-BC

Report on thickness measurement of longitudinal members (one, two or three transverse sections)

Ship's name..... IMO number..... Class identity No..... Report No.....

STRUCTURAL MEMBER	FIRST TRANSVERSE SECTION AT FRAME NUMBER								SECOND TRANSVERSE SECTION AT FRAME NUMBER								THIRD TRANSVERSE SECTION AT FRAME NUMBER										
	Item No.	Org. thk.	Max. alwb. dim.	Gauged		Diminution P		Diminution S		Item No.	Org. thk.	Max. alwb. dim.	Gauged		Diminution P		Diminution S		Item No.	Org. thk.	Max. alwb. dim.	Gauged		Diminution P		Diminution S	
				P	S	mm	%	mm	%				mm	%	P	S	mm	%				mm	%	P	S	mm	%

Operator's signature.....

Notes – see following page".

4 ALBERT EMBANKMENT
LONDON SE1 7SR
Telephone: +44 (0)20 7735 7611 Fax: +44 (0)20 7587 3210

MSC.1/Circ.1500/Rev.1
17 May 2018

GUIDANCE ON DRAFTING OF AMENDMENTS TO THE 1974 SOLAS CONVENTION AND RELATED MANDATORY INSTRUMENTS

1 The Maritime Safety Committee (the Committee), at its ninety-fourth session (17 to 21 November 2014), having considered a number of issues related to the drafting of amendments to the International Convention for the Safety of Life at Sea, 1974, as amended (the Convention) and related mandatory instruments, from the initial proposal and preparation process to the approval and adoption stages and entry into force of amendments, approved the *Guidance on drafting of amendments to the 1974 SOLAS Convention and related mandatory instruments* (MSC.1/Circ.1500) (hereinafter referred to as the Guidance).

2 The Committee, at its ninety-ninth session (16 to 25 May 2018), having considered the amendments proposed by the Secretariat to address the Committee's decisions taken after the approval of the Guidance, regarding its application to the 2011 ESP, IBC, IGC, IMDG and IMSBC Codes, amendments considered and finalized by sub-committees in plenary within one session, minor corrections and procedure for the production of certified true copies, approved the revised Guidance, as set out in the annex.

3 Without prejudicing the amendments procedure specified in article VIII of the Convention and the provisions set out in the *Organization and method of work of the Maritime Safety Committee and the Marine Environment Protection Committee and their subsidiary bodies* (MSC-MEPC.1/Circ.5/Rev.1), the information contained in the annex provides relevant guidance for the drafting of amendments to the Convention and related mandatory instruments, including procedural aspects related to the approval and adoption of amendments.

4 Contracting Governments to the Convention are invited to take into account the provisions of the present Guidance when submitting proposals for amendments in accordance with article VIII(b)(i) of the Convention and/or proposals for new outputs in accordance with section 4 of the *Organization and method of work of the Maritime Safety Committee and the Marine Environment Protection Committee and their subsidiary bodies* (MSC-MEPC.1/Circ.5/Rev.1).

5 The Committee and its subsidiary bodies, including working, drafting and intersessional groups, should apply the present Guidance during the preparation of draft amendments to the Convention and related mandatory instruments, as well as during the approval and adoption stages.

ANNEX

GUIDANCE ON DRAFTING OF AMENDMENTS TO THE 1974 SOLAS CONVENTION AND RELATED MANDATORY INSTRUMENTS

TABLE OF CONTENTS

- 1 INTRODUCTION**
- 2 GOALS**
- 3 PROCEDURAL ASPECTS RELATED TO THE DRAFTING OF AMENDMENTS**
 - 3.1 Timing of entry into force of amendments
 - 3.2 Amendment control process
 - 3.2.1 Process for amending the Convention and related mandatory instruments (from proposal to adoption)
 - 3.2.2 Drafting group arrangements
 - 3.2.3 Use of tracked changes
 - 3.3 Points for attention in preparing an amendment
 - 3.3.1 An amendment to a pending amendment
 - 3.3.2 Work of other bodies of the Organization
- 4 GUIDANCE FOR DRAFTING AMENDMENTS**
 - 4.1 Principles
 - 4.1.1 A comprehensive revision of a chapter
 - 4.1.2 Amendments adopted between comprehensive revisions
 - 4.1.3 Amendments adopted at a subsequent comprehensive revision
 - 4.1.4 Referencing other instruments
 - 4.1.5 Relationships between the Convention and related mandatory instruments
 - 4.1.6 Relaxation/dispensation
 - 4.2 Specific details
 - 4.2.1 Format of application dates
 - 4.2.2 All ships
 - 4.2.3 Conversion
 - 4.2.4 Consequential amendments to the Convention and/or other instruments
 - 4.2.5 Other best practices for the drafting of amendments
 - 4.2.6 Format of application date to be used in mandatory instruments
 - 4.3 Example of regulation 1
- 5 OTHERS – REMINDER OF THE BASIC ARCHITECTURE OF THE CONVENTION**
 - 5.1 Application provisions
 - 5.2 Application to new/existing ships
 - 5.3 Ship type
 - 5.4 Status of footnotes
 - 5.5 Human element

Annex 1 EXAMPLE OF REGULATION 1

Annex 2 CHECK/MONITORING SHEET FOR THE PROCESS OF AMENDING THE
CONVENTION AND RELATED MANDATORY INSTRUMENTS
(PROPOSAL/DEVELOPMENT)

Annex 3 RECORD FORMAT

1 INTRODUCTION

1.1 This note provides guidance for the drafting of amendments to the International Convention for the Safety of Life at Sea, 1974 (the Convention), and related mandatory instruments (hereinafter referred to as the Guidance). It also contains procedural aspects related to the approval and adoption of related amendments.

1.2 This Guidance does not fully apply to amendments to an article of the Convention or to chapter I of the annex to the Convention, where an explicit amendment procedure is required.

1.3 This Guidance should always be read with reference to the provisions of article VIII for amending the Convention and in conjunction with the *Organization and method of work of the Maritime Safety Committee and the Marine Environment Protection Committee and their subsidiary bodies* (MSC-MEPC.1/Circ.5/Rev.1) and the *Guidance on entry into force of amendments to the 1974 SOLAS Convention and related mandatory instruments* (MSC.1/Circ.1481).

1.4 The process described in this Guidance summarizes the most common actions for the consideration and development of amendments to the Convention and related mandatory instruments. Although the approval of draft amendments is not a mandatory requirement under the amendments procedure specified in article VIII of the Convention, it has become the practice of the Committee to submit draft amendments for approval prior to their adoption.

2 GOALS

2.1 The Guidance is meant to ensure that submission and development of new or amended regulations are carried out in an appropriately comprehensive and detailed manner and, in particular, that:

- .1 the application of regulations is sufficiently clear and without the need for additional interpretation;
- .2 the nomenclature related to the application and the structure of chapters are harmonized through the entire Convention;
- .3 the implementation of either amendments or new provisions is improved and facilitated through a specified interval between entry into force of successive sets of amendments; and
- .4 Contracting Governments to the Convention, the Maritime Safety Committee (the Committee) and its subsidiary bodies, including working and drafting groups, as well as other interested parties, are provided with appropriate guidance on drafting of amendments to the Convention and its related mandatory instruments.

2.2 In order to achieve the above goals, the Guidance is based on the following two main principles:

- .1 a systematic control process throughout the different stages of the amendments' development; and
- .2 relevant guidance for drafting amendments.

3 PROCEDURAL ASPECTS RELATED TO THE DRAFTING OF AMENDMENTS

3.1 Timing of entry into force of amendments

3.1.1 The Committee, at its ninety-third session, approved the *Guidance on entry into force of amendments to the 1974 SOLAS Convention and related mandatory instruments* (MSC.1/Circ.1481), which reinstated the four-year cycle of entry into force of amendments to the Convention and related mandatory instruments. In this respect, due attention should be paid to the timeline agreed for the entry into force of amendments when developing amendments to the Convention and related mandatory instruments.

3.1.2 Notwithstanding paragraph 3.1.1 above, the Guidance should not apply, in its entirety, to the 2011 ESP, IMDG and IMSBC Codes which are updated continuously (i.e. annually and biennially), and chapter 17 of the IBC Code and chapter 19 of the IGC Code should not be subject to the Guidance.

3.2 Amendment control process

3.2.1 Process for amending the Convention and related mandatory instruments (from proposal to adoption)

3.2.1.1 At a proposal stage and in addition to the information to be provided in proposals for new outputs (see annex 1 to the *Organization and method of work of the Maritime Safety Committee and the Marine Environment Protection Committee and their subsidiary bodies* (MSC-MEPC.1/Circ.5/Rev.1)), where possible, the following elements should be addressed when considering proposals for a new output that may require the preparation of amendments to the Convention and/or related mandatory instruments:

- .1 ship type(s) to which the proposed amendment(s) is/are expected to apply (e.g. scope, size, type, tonnage/length restriction; service areas (international/non-international); activities (e.g. supporting diving activities));
- .2 the extent of application to existing ships,¹ along with any relevant safety measures that may be applied to existing ships;
- .3 the intended instrument(s) that should be amended (i.e. the Convention and associated mandatory instruments); and
- .4 the use of the check/monitoring sheet (refer to paragraph 3.2.1.3.16 below).

3.2.1.2 During the consideration of new outputs, and in addition to the actions to be taken based on MSC-MEPC.1/Circ.5/Rev.1, the Committee should consider the elements listed below and, in this respect, should give clear instructions to the relevant technical subsidiary body/bodies (i.e. sub-committees, including their working/drafting/intersessional groups, as well as those reporting directly to the Committee), as may be applicable:

- .1 target completion date at the sub-committee level;
- .2 expected date(s) of entry-into-force and implementation/application date(s) (e.g. possible phase-in arrangement for existing ships) of the amendment(s) or of the new requirement(s) to be developed;

¹ Refer to the *Interim guidelines for the systematic application of the grandfather clauses* (MSC/Circ.765-MEPC/Circ.315).

- .3 whether the proposal should be considered an exceptional circumstance, as specified in MSC.1/Circ.1481; and
- .4 scope of application of the proposed amendment(s) or new requirement(s), along with the instrument(s) which would be required to be amended/developed. In this regard, the following should be taken into consideration:
 - .1 if a comprehensive revision to an instrument is required, a decision should be taken whether to revise the existing instrument or create a new version, which may co-exist with the existing instrument (e.g. 1994 and 2000 HSC Codes); and
 - .2 if the instrument to be amended has different versions, a decision should be made whether older versions of the instrument should also be revised, especially when considering amendments to operational requirements which are likely to result in the revision to all versions of the instrument.

3.2.1.3 At a subsequent processing stage, but before the conclusion of the approval for adoption, each allocated sub-committee should ensure that:

- .1 at an initial engagement, sufficient time is allocated for technical research and discussion before the target completion date, especially when the issue is needed to be addressed by more than one sub-committee where timing of meetings of relevant sub-committees and exchanges of the result of considerations need to be carefully examined;
- .2 the intended scope of application agreed by the Committee (refer to paragraph 3.2.1.2 above) is not changed without approval of the Committee, providing clear justification for such change (e.g. in case of unintended omissions);
- .3 the technical base document or draft amendment addresses the proposal's issue(s) through the suggested instrument(s) and, if not, an alternative method is offered to the Committee for addressing the problem raised by the proposal;
- .4 if application to existing ships is agreed by the Committee under paragraph 3.2.1.1.2 above, due attention is paid to the *Interim guidelines for the systematic application of the grandfather clauses* (MSC/Circ.765-MEPC/Circ.315);
- .5 all references have been examined against the text that would be valid if the proposed amendment enters into force (refer to section 4.2.4 below);
- .6 the location of the inserted or modified text is correct with regard to the text that would be valid when the proposed amendment enters into force on a four-year cycle entry-into-force date, as there may be other relevant amendments adopted that might enter into force on the same date;
- .7 there are no inconsistencies between the scope of application of a particular technical regulation and the application statement of the relevant chapter that may be given in regulations 1 or 2, and application is specifically addressed for existing and/or new ships, as necessary;

- .8 if a new term is introduced in a regulation and a clear definition is necessary, the definition is given in the relevant article of the Convention or at the beginning of the chapter, as appropriate;
- .9 when terms such as "fitted", "provided", "installed" or "installation" are used, a clear understanding of the intended meaning of the term is provided;
- .10 all necessary related and consequential amendments to other existing instruments, including non-mandatory instruments, in particular the forms of certificates and records of equipment required in the instrument being amended, have been examined and included as a part of the amendment(s);
- .11 the forms of certificates and records of equipment are harmonized, where appropriate, between the Convention and its Protocols;²
- .12 attention is paid with regard to the possible application's criteria using building contract date, keel laying date or delivery date, as and where appropriate, and to the possible impact of that decision (refer to section 4.2.1). In making such a decision, the following should be taken into consideration:
- .1 in principle, the three-date system can be used for a chapter or regulation/paragraph governing design/construction of a ship, while the keel laying date can be used for a chapter or regulation/paragraph governing ship's equipment;
 - .2 the period to be established between events in the three-date system versus the actual timing needed in the shipbuilding process;
 - .3 the period needed between adoption and entry into force versus the time for design, manufacture and approval of new equipment;
 - .4 that a single keel laying date implementation criteria could require a series of ships under the same building contract to apply different requirements (pre- and post-entry into force) which may cause significant changes to the design;
 - .5 with respect to application to existing ships, the need to carefully word the three-date criteria implementation scheme (e.g. application of certain "measures" of the Noise Code) versus the more straightforward application of a single keel laying criteria; and
 - .6 where a phase-in arrangement for existing ships is deemed appropriate and that arrangement is based on the first survey or dry-docking after a specified date, the date of completion of the first scheduled survey or the date of completion of the first scheduled dry-docking should be used;³
- .13 draft amendments are presented for consideration, as far as practically possible, as tracked changes within the context of the relevant provisions to be amended (refer to section 3.2.3 below);

² Refer to the Committee's decision, as reported in document MSC 72/23, paragraph 3.10.

³ Refer to the *Unified interpretation of the date of completion of the survey and verification on which the certificates are based* (MSC-MEPC.5/Circ.3).

- .14 due attention is paid to the "application" and "definition" regulations/ paragraphs of the chapter where these are likely to affect or be affected by the proposed amendments;
- .15 when preparing amendments to mandatory instruments, the relationship between the Convention and the instrument is observed (refer to section 4.1.5);
- .16 the check/monitoring sheet given in annex 2 is observed and completed throughout the progress at each one of the above stages. In this respect, it is intended that:
 - .1 parts I and II should be completed by the submitter of a proposal for a new output, as far as possible, as an annex to the submission document (refer to paragraph 3.2.1.1.4 above); and
 - .2 part III should be completed by the drafting or working group that prepares the draft amendment(s);⁴
- .17 the final draft text of proposed amendments to the Convention or any related mandatory instrument is reviewed by either a drafting group or by a working group⁴ to properly address the issues listed in part III of the check/monitoring sheet, as given in paragraph 3.2.2.2 below;
- .18 the check/monitoring sheet is presented along with the draft amendments submitted for approval; and
- .19 the record format given in annex 3 is completed in the module "Development of amendments to the 1974 SOLAS Convention and related mandatory instruments" of GISIS by the drafting or working group that prepares the draft amendment(s).⁴

3.2.1.4 At the approval and adoption stages:

- .1 the Committee should:
 - .1 carefully review the draft amendments submitted for approval, using the associated check/monitoring sheet prepared by the subsidiary body. In doing so, issues requiring further drafting consideration may be identified. Under those circumstances, the Committee may consider instructing the drafting group on amendments to review the draft amendments and the associated check/monitoring sheet before approval of the related amendments, taking into account the information contained in the related record format; and
 - .2 agree on which session of the Committee the amendments should be adopted as well as the dates on which the amendments would be accepted and would enter into force, taking into account the four-year cycle or the exceptional circumstance as per MSC.1/Circ.1481, as may be the case; and

⁴ For the draft amendments to be considered and finalized by sub-committees in plenary within one session, the Secretariat may be requested, when necessary, to complete part III of the check/monitoring sheet and the records for regulatory development after the session, instead of establishing a specific working/drafting group. "Minor corrections" (C/ES.27/D, paragraph 3.2(vi)) may be excluded from application of the provisions for completion of the check/monitoring sheet and the records for regulatory development.

- .2 the Secretariat should:
 - .1 ensure that the draft amendments submitted for approval, as well as those contained in the annexes of the Committee's report after approval, are presented in tracked changes, as appropriate (refer to section 3.2.3 below);
 - .2 prepare the appropriate text of draft amendments without tracked changes for circulation to all Members of the Organization and all SOLAS Contracting Governments after approval, in accordance with the provisions of article VIII of the Convention;
 - .3 prepare documents containing the text of the approved draft amendments without tracked changes, together with the draft resolution(s), for submission to the session of the Committee that will consider the amendments for adoption;
 - .4 prepare a working paper consolidating all draft amendments submitted for adoption with tracked changes, including proposals for modifications or editorial improvements, if any, as well as notes and comments, as appropriate (refer to section 3.2.3 below). This document should be made available in IMODOCS as soon as possible after the deadline for commenting documents and should be used as the base document for the preliminary consideration by the expanded Committee and final revision by the drafting group on amendments;
 - .5 ensure that, after adoption, the final text of the amendments which are contained in the annexes of the Committee's report (i.e. the MSC resolutions) is presented without tracked changes;
 - .6 prepare the authentic text of the adopted amendments after adoption, when requested, and make it available on IMODOCS;⁵ and
 - .7 keep the related record format updated in respect to relevant decisions taken at the sub-committee or committee level.

3.2.2 Drafting group arrangements

3.2.2.1 Drafting groups have a relevant role in the amendment control process. Although drafting groups cannot change the essence of the amendments, they should ensure that the drafting of amendments is carried out in accordance with the present Guidance. Therefore, this Guidance should be included as a standing reference in the terms of reference of these groups, along with references for completion of the check/monitoring sheet and record format, set out in annexes 2 and 3, respectively.

⁵ The whole process of the production of certified true copies, in all cases, should not take longer than 100 days for non-bulky documents (those containing six pages or fewer) and 160 days for bulky documents (those containing more than six pages) after the date of adoption of the amendment.

3.2.2.2 The first stage of the engagement in the control process of drafting works should be undertaken by a drafting group or by a working group of the subsidiary body or by those reporting directly to the Committee.⁶ In doing so, the check/monitoring sheet set out in annex 2 should be observed and completed before submitting the draft amendments for approval.

3.2.2.3 At the approval stage of amendments, the Committee should carefully review the draft amendments submitted for approval, along with the related check/monitoring sheet (refer to paragraph 3.2.1.4.1.1).

3.2.2.4 Depending upon the findings in the check/monitoring sheet, the Committee may consider tasking the drafting group established for reviewing the amendments submitted for adoption (refer to paragraph 3.2.2.6 below) to review the draft amendments submitted for approval and the related check/monitoring sheet, including the information contained in the related record format.

3.2.2.5 After the approval of draft amendments by the Committee, the Secretariat should review the approved draft amendments from the drafting and editorial point of view. Any findings by the Secretariat should be submitted to the session of the Committee that would adopt the amendments as part of the working paper consolidating the amendments, comments and proposals for modifications, which would be prepared in advance by the Secretariat (see paragraph 3.2.1.4.2.4).

3.2.2.6 At the adoption stage, the above-mentioned working paper should be used as the basis document for consideration of the draft amendments by the expanded Committee and by the drafting group that would conduct the final review of the draft amendments, along with any comments provided in any of the documents submitted to that session for consideration.

3.2.3 Use of tracked changes

3.2.3.1 The use of tracked changes during the preparation, approval and adoption of draft amendments may facilitate the consideration of proposed amendments. It may also assist the work of translators and reduce the number of misinterpretations.

3.2.3.2 Tracked changes should mainly be used, as far as practically possible, for draft amendments to the text of existing regulations, paragraphs or tables, in order to easily identify the changes proposed with respect to the original text. In this respect, only the relevant part(s) of the original text should be reproduced.

3.2.3.3 For insertions of new regulations, paragraphs or tables, or deletion of existing ones, the use of tracked changes may not be practical.

3.2.3.4 Tracked changes should be created using "strikeout" for deleted text and "grey shading" to highlight all modifications and new insertions, including deleted text (i.e. not using the track changes function of Microsoft Word), in order to ensure that such changes are not lost during further editorial work (e.g. cut and paste).

⁶ For the draft amendments to be considered and finalized by sub-committees in plenary within one session, the Secretariat may be requested, when necessary, to complete part III of the check/monitoring sheet and the records for regulatory development after the session, instead of establishing a specific working/drafting group. "Minor corrections" (C/ES.27/D, paragraph 3.2(vi)) may be excluded from application of the provisions for completion of the check/monitoring sheet and the records for regulatory development.

3.2.3.5 Tracked changes should be made against the text that has already entered into force. However, subject to section 3.3.1 below, if the draft amendments under development are expected to be adopted after the entry-into-force date of other related amendments, then the adopted amendments should be included using a different colour and including a note indicating the number of the resolution by which the amendments were adopted. The note should be used as a drafting tool only and should not be considered as part of the related draft amendments.

3.3 Points for attention in preparing an amendment

3.3.1 *An amendment to a pending amendment*

3.3.1.1 A further amendment to an already adopted amendment which is still pending entry into force may be approved by the Committee but should not be adopted until the previous adopted amendment enters into force.

3.3.1.2 Other elements of the same regulation which are not related to a previous adopted amendment which is still pending entry into force may be amended accordingly, in accordance with the procedures for amending the Convention.

3.3.2 *Work of other bodies of the Organization*

3.3.2.1 In drafting an amendment, due attention should be paid to any possible related amendments being prepared by other bodies of the Organization based upon the information provided by the Secretariat or as may be advised.

4 GUIDANCE FOR DRAFTING AMENDMENTS

4.1 Principles

4.1.1 *A comprehensive revision of a chapter*

4.1.1.1 A comprehensive revision is a revision of a chapter which fundamentally alters the structure of the chapter and resets its application date.

4.1.1.2 A comprehensive revision should take place only if the entire philosophy or basis of the chapter is restructured (e.g. from ship's type-based requirements to functional based requirements, or based on a new concept).

4.1.1.3 As far as possible, comprehensive revisions should be avoided since they can make historical tracking of regulations difficult.

4.1.1.4 When a chapter of the Convention is comprehensively revised, the following principles should be followed:

- .1 application date of the chapter: The application date of the chapter should be reset. The application date (e.g. DDMMYYYY in annex 1) in the statement of regulation 1.1.1 "Unless expressly provided otherwise, this chapter shall apply to ships constructed on or after DDMMYYYY" should be kept until the next comprehensive revision of the chapter. This date should be aligned with one of the four-year cycle dates;

- .2 list of resolutions: A list of resolutions that apply to ships constructed prior to the comprehensive revision (e.g. regulation 1.2 in annex 1) should be included in the text of the chapter; and
- .3 additional requirements contained in the chapter that apply to ships constructed before the application date of the chapter: When a comprehensive revision is carried out, some of the requirements applicable to ships constructed on or after the application date of the chapter may also be applicable to ships constructed before that date. These regulations should be recorded in the list of regulations applicable to existing ships (see regulation 1.4 in annex 1).

4.1.2 Amendments adopted between comprehensive revisions

4.1.2.1 For amendments adopted between comprehensive revisions, the following principles should be observed:

- .1 the application date of a new amendment should be clearly stated under each specific new or amended regulation/paragraph, in the format given in section 4.2.1 below;
- .2 if an amendment revises a regulation/paragraph, or part of a regulation/paragraph, the original part of the regulation/paragraph which would continue being applicable to ships constructed on or after the original application date of the revised regulation/paragraph should be retained with a clear statement of its application dates (i.e. from and to);
- .3 regardless of the dates included in the amended regulation(s)/paragraph(s), the chapter's application should include a list of amended regulations/paragraphs that contain provisions that apply to ships constructed on or after the general application date of the chapter (e.g. regulation 1.3 in annex 1); and
- .4 if the new or amended regulation/paragraph is also applicable to ships constructed before the general application date of the chapter, then that regulation/paragraph should also be added to the list referred to in paragraph 4.1.1.4.3 (e.g. regulation 1.4 in annex 1).

4.1.3 Amendments adopted at subsequent comprehensive revision

4.1.3.1 In the event of a second or a subsequent comprehensive revision to a chapter, the following principles should also be observed:

- .1 the application date of the chapter given in paragraph 4.1.1.4.1 above should be reset;
- .2 the list of resolutions referred to in paragraph 4.1.1.4.2 should be updated by adding any further resolutions relevant to the chapter adopted after the previous comprehensive revision; and
- .3 application dates introduced in the regulations/paragraphs that entered into force between the comprehensive revisions should be removed, and the list indicated in paragraph 4.1.2.1.3 should also be reset. Moreover, the list indicated in paragraph 4.1.1.4.3 should be reset and completed with requirements contained in the revised chapter that apply to ships constructed before the subsequent revision date, if any.

4.1.4 Referencing other instruments

4.1.4.1 When referencing other mandatory/non-mandatory instruments in a mandatory instrument, the *Guidelines on methods for making reference to IMO and other instruments in IMO conventions and other mandatory instruments*, as set out in the annex to resolution A.911(22) on *Uniform wording for referencing IMO documents*, should be applied.

4.1.4.2 The above Guidelines provide standard text for references for inclusion in new IMO conventions and other mandatory instruments relating to maritime safety and pollution prevention and in future amendments to existing conventions and other instruments, in order to ensure that, where reference is made to IMO conventions and other instruments, a uniform wording is used. This is to indicate clearly the legal status of the instrument in question after the IMO body concerned has decided on the status. Therefore, references to standards which are intended to be mandatory should not be included as a footnote. They should instead be included explicitly in the text of relevant regulations/paragraphs or amendments.

4.1.5 Relationships between the Convention and related mandatory instruments

General principles

4.1.5.1 The relationship between the Convention and a mandatory instrument should be clearly identified in both the Convention and the mandatory instrument.

4.1.5.2 Instruments are made mandatory through reference in the text of the SOLAS regulations. Thus, the application of the mandatory instrument cannot exceed the relevant SOLAS regulation.

4.1.5.3 In drafting new instruments or amendments, care should be taken to ensure consistency between the Convention and the related mandatory instrument.

4.1.5.4 If a decision is taken to develop a new version of an instrument with co-existing sets of requirements (refer to paragraph 3.2.1.2.4), applicability should be clearly defined within the Convention, especially regarding the scope and dates of application/ implementation.

4.1.5.5 If different parts of an instrument have different characteristics, mandatory and recommendatory, the different relationships to the Convention should be indicated in the Convention.

Instruments providing an alternative or additional set of requirements to the Convention for particular ship types or providing supplementary requirements for specific circumstances

4.1.5.6 For instruments providing an alternative set of requirements to the Convention for particular ship types, such as the IGC, IBC and the 1994 and 2000 HSC Codes, or providing supplementary requirements for specific circumstances, the following should be taken into consideration:

- .1 the scope of application should be detailed in the instrument using the principles laid down in sections 4.1.1 to 4.1.3 and 4.2.1, accordingly; and
- .2 the relationship between the Convention and the instrument should be clearly identified in the applicable chapter of the Convention, in the definition of the instrument concerned and in any specific regulation addressing the application of the instrument.

Instruments governing operational and survey/audit elements

4.1.5.7 With regard to instruments governing operational and survey/audit elements, such as the 2011 ESP, ISM or RO Codes, a clear definition of the instrument and its status, whether mandatory or recommendatory, as well as the scope of application, should be provided in the Convention. Any subsequent amendment to the instrument is understood to have the same application as the original, unless otherwise specified. Nevertheless, attention should be paid to:

- .1 whether either the instrument or the Convention should further clarify ship types that are subject to the proposed requirements; and
- .2 application statements that may be indicated in the resolution adopting the amendments to clarify application criteria, for example, the first survey/audit after the given date or actual date of the activity.

Other instruments

4.1.5.8 In instruments other than those specified in paragraphs 4.1.5.6 and 4.1.5.7, the application principle should be clearly stated at the beginning of the instrument. In these cases, attention should be paid to:

- .1 whether to set up a principle for application criteria of any amendment, not specifically indicating the application date of each amendment (e.g. the FSS Code, section 1.1.2) or;
- .2 if not, whether the application provision of the amendment should be clearly stated and/or a chronological record of the amendments be maintained for each section; and
- .3 where specific equipment is identified as necessary, the carriage of such equipment can only be required by inclusion in the Convention.

4.1.6 Relaxation/dispensation

4.1.6.1 General relaxation/dispensation clauses should be given at the beginning of the chapter.

4.1.6.2 Specific relaxation/dispensation clauses applicable to specific requirements should be given under the technical regulations.

4.2 Specific details

4.2.1 Format of application dates

4.2.1.1 Format of application dates should be defined, as applicable, using the criteria based on "three dates"⁷ or the "keel laying date based on a single date".

⁷ Refer to MSC-MEPC.5/Circ.8 on *Unified interpretation of the application of regulations governed by the building contract date, the keel laying date and the delivery date for the requirements of the SOLAS and MARPOL Conventions.*

4.2.1.2 At a comprehensive revision, a decision should be made as to whether to use the criteria based on three dates or the keel laying date based on a single date. Depending on that decision, one of the following definitions of the chapter's application for "ship constructed" should be inserted in the regulation corresponding to the "application" or "definition" part of the chapter:

- .1 In case the three dates criteria is used, the following should be the definition inserted:

"The expression *ship constructed on or after DDMMYYYY* means:

- .1 for which the building contract is placed on or after (date 1); or
- .2 in the absence of a building contract, the keel of which is laid or which is at a similar stage of construction on or after (date 2); or
- .3 the delivery of which is on or after (date 3)".

Note: As guidance, date 1 is DDMMYYYY, date 2 is 6 months after date 1, and date 3 is 48 months after date 1.

- .2 In case the single ship's construction/keel laying date criteria is used, the following should be the definition inserted:

"The expression *ship constructed on or after DDMMYYYY* means:

- .1 the keel of which is laid or which is at a similar stage of construction on or after DDMMYYYY;
- .2 *Similar stage of construction* means the stage at which:
- .1 construction identifiable with a specific ship begins; and
- .2 assembly of that ship has commenced comprising at least 50 tonnes or 1% of the estimated mass of all structural material, whichever is less."

4.2.1.3 Subsequent amendments between comprehensive revisions should also address the options given in paragraph 4.2.1.2 above.

4.2.2 All ships

4.2.2.1 When used, a clear definition of the term "all ships" for the purpose of the chapter should be given in the "application" or "definition" part of the chapter.

4.2.3 Conversion

4.2.3.1 A clear definition of "conversion" and "alteration or modification of major character" for the purpose of application provisions of the chapter or a specific regulation should be given.

4.2.4 Consequential amendments to the Convention and/or other instruments

4.2.4.1 An amendment to the Convention occasionally introduces a change to the regulation number or paragraph number. As far as possible, this practice should be avoided because the number might be referred to in the Convention itself or in other instruments. MSC 71, when discussing the situation regarding cross-reference of regulations in and between IMO instruments, agreed to (MSC 71/23, paragraph 16.10):

- .1 request the sub-committees, in the course of preparation of amendments to IMO instruments, to also check the references in the provisions of the instruments concerned which may not be within their purview; and
- .2 invite Member Governments to inform the Secretariat, at an early stage, of any modifications to cross-references they would identify when introducing new amendments in their legislation, in order that necessary rectification could be made by the Secretariat.

4.2.5 Other best practices for the drafting of amendments

4.2.5.1 In addition to principles specified in section 4.1, the following best practices should be taken into account during the preparation and drafting of amendments to the Convention:

- .1 General format of regulations:
 - .1 titles of regulations: for consistency, all regulations should have a title;
 - .2 subtitles within regulations should be numbered accordingly; and
 - .3 numbering of paragraphs and tables within a regulation: unless the regulation contains only one paragraph or table, all paragraphs and tables should be numbered accordingly within the regulation. For tables, the format "x.y" should be used, where "x" represents the number of the regulation and "y" is a correlative number within the regulation.
- .2 New regulations: Whenever possible, new regulations should be inserted at the end of the corresponding chapter. However, due to the nature of the regulation and/or the structure of the chapter, new regulations may be inserted sometimes between existing regulations. In these cases and in order to avoid renumbering existing regulations, the new regulation should be inserted using an existing regulation number by adding "-1" after the number. For further insertions, correlative numbers should be used.
- .3 Deletion of regulations: To avoid renumbering existing regulations, the number of deleted regulations should be kept. A footnote could be added indicating that the regulation was intentionally deleted and left blank.
- .4 Amending or replacing existing regulations, paragraphs or tables: Given the diversity of situations that could be presented under the current structure of the Convention, special attention should be paid to the definition of the scope of application of new amendments, as appropriate. Under these circumstances, the scope of application of new amendments should be specified as follows:
 - .1 within the amended text of the existing regulation; or

- .2 using a dedicated separate paragraph within the same regulation; or
- .3 adding a note within parentheses under the title of the regulation.

When modifying or replacing contents of existing tables, a note under the table or a dedicated separate paragraph should be used to clarify the application of existing requirements, as appropriate.

Duplication of regulations, paragraphs or tables should be avoided as much as possible.

4.2.6 Format of application date to be used in mandatory instruments

4.2.6.1 In instruments providing an alternative set of requirements to the Convention for particular ship types or providing supplementary requirements for specific circumstances (refer to paragraph 4.1.5.6), the format of application date should follow section 4.2.1.

4.2.6.2 In instruments governing operational and survey/audit elements (refer to paragraph 4.1.5.7):

- .1 where a single date of application is used and not changed, it is not necessary to track the amendments; or
- .2 where a single date of application is not used or a previous date of application is changed, then the format described in section 4.2.1 should be used.

4.2.6.3 In other mandatory instruments (refer to paragraph 4.1.5.8), the following format of application dates may be used:

- .1 when the installation date is used:

"Unless expressly provided otherwise, this instrument is applicable to installations (equipment, appliances, fittings, etc.) installed on board ships on or after DDMMYYYY.

The expression *installations (the type of installations should be clearly specified here) installed on board ships on or after DDMMYYYY* means:

- (a) for ships the keel of which is laid or which is at a similar stage of construction on or after DDMMYYYY, all installations of the specified type on board those ships; or
- (b) for ships other than those specified in (a), all installations of the specified type, having a contractual delivery date to the ship on or after (DDMMYYYY + x) or, in the absence of a contractual delivery date to the ship, actually delivered to the ship on or after (DDMMYYYY + y)."

Notes:

- .1 if an amendment is not applicable to all ships, then the general application provisions of the instrument or its particular chapter should be taken into account; and

.2 "x" and "y" are time frames to be decided based on consideration of the specified type of installations to be installed;

.2 otherwise, the format given in section 4.2.1 should be used.

4.3 Example of regulation 1

An example of regulation 1 is given in annex 1.

5 OTHERS – REMINDER OF THE BASIC ARCHITECTURE OF THE CONVENTION

5.1 Application provisions

5.1.1 Application provisions in the Convention are given in three layers:

.1 article II (Application): article II of the Convention states that:

"The present Convention shall apply to ships entitled to fly the flag of States the Governments of which are Contracting Governments."

.2 chapter I, regulation 1 (Application): regulation I/1 of the Convention states that:

"(a) Unless expressly provided otherwise, the present regulations apply only to ships engaged on international voyages.

(b) The classes of ships to which each chapter applies are more precisely defined, and the extent of the application is shown, in each chapter."

.3 Each chapter: each chapter, in regulations 1 or 2, provides application of that chapter.

.4 Each regulation: each regulation may provide further specific application details of the requirement.

5.2 Application to new/existing ships

5.2.1 In drafting a regulatory text, there should be a clear understanding of the nature of modifications to the technical regulations and of the scope of application of newly introduced or additional technical measures, e.g. whether they should be applied to "new ships", or "existing ships" (i.e. ships which are not new ships), or both; as well as the time frame for the amendments introducing the technical measures to come into force. It is essential to have proper understanding of the following:

.1 article VIII (Amendments):

"(e) Unless expressly provided otherwise, any amendment to the present Convention made under this article, which relates to the structure of a ship, shall apply only to ships the keels of which are laid or which are at a similar stage of construction, on or after the date on which the amendment enters into force."; and

- .2 *Organization and method of work of the Maritime Safety Committee and the Marine Environment Protection Committee and their subsidiary bodies (MSC-MEPC.1/Circ.5/Rev.1):*

In paragraph 4.26, some guidance on the application to new/existing ships is provided.

5.3 Ship type

5.3.1 For ship types, it is noted that, unless expressly provided otherwise, regulation I/2 applies. If a regulation/paragraph applies to a particular ship type, this should be clearly stated in the regulation/paragraph. If a ship type, other than that stated in regulation I/2, or as may be specified in the chapter under amendment, is introduced, then a corresponding definition for that ship type should be specified within that chapter.

5.4 Status of footnotes

5.4.1 The *Guidelines on methods for making reference to IMO and other instruments in IMO conventions and other mandatory instruments*, adopted by resolution A.911(22), reflect that standards and specifications referred to in footnotes, as well as guidelines and recommendations, should not appear in the authentic text of mandatory instruments but may be included in sales publications and updated by the Secretariat as necessary when a new edition of the relevant publication is prepared.

5.4.2 For future amendments to the Convention or related mandatory instruments, text intended to be a mandatory part of the instrument should not be included in a footnote.

5.5 Human element

5.5.1 Reference is made to paragraph 4.27 of the *Organization and method of work of the Maritime Safety Committee and the Marine Environment Protection Committee and their subsidiary bodies (MSC-MEPC.1/Circ.5/Rev.1)*, which states that, recognizing the human factor as an integral part of any effort to enhance maritime safety, maritime security or protection of the marine environment, the subsidiary bodies should consider the human factor whenever new requirements are developed and existing requirements are reviewed, by taking into account the human element principles, as set out in the annex to resolution A.947(23) on *Human element vision, principles and goals for the Organization*.

ANNEX 1

EXAMPLE OF REGULATION 1

Regulation 1 should be expressed as:

"Regulation 1 – Application

1 Application (refer to section 4.1.1.4.1 – Application date of the chapter)

1.1 Unless expressly provided otherwise, this chapter shall apply to ships constructed on or after [DDMMYYYY] (refer to paragraph 4.1.1.4.1)

2 Resolutions applicable to ships constructed before [DDMMYYYY] (refer to paragraph 4.1.1.4.2)

Unless expressly provided otherwise, for ships constructed before [DDMMYYYY], the Administration shall ensure that the requirements which are applicable under chapter [...] of the International Convention for Safety of Life at Sea, 1974, as amended by resolutions MSC.[...] ([...]) (the resolution of the previous revision) are complied with. (Note: this should be the previous comprehensive revision).

3 Additional or revised regulations applicable to ships constructed on or after [DDMMYYYY] (refer to paragraph 4.1.2.1.3)

Regulation	Application date	Adopted by
II-2/1.2.4	first renewal survey on or after 1 January 2011	MSC.269(85)
II-2/4.5.2.3	on or after 1 July 2008	MSC.216(82)
II-2/5.3.4	first survey on or after 1 July 2008	MSC.216(82)

4 Requirements contained in this chapter that are applicable to ships constructed before [DDMMYYYY] (refer to paragraph 4.1.1.4.3)

Regulation	Application date	Adopted by	Applicable ship types
II-2/1.2.2	see paragraphs 2.2.1 to 2.2.4	MSC. 99(73)	as applicable
II-2/4.5.7.1	1 January 2012	MSC. 291(87)	in all tankers
II-2/15, heading, first sentence	1 July 2010	MSC.201(81)	applicable to passenger ships and cargo ships from 500 GT with building contract date between 1 February 1992 and 1 July 1998

ANNEX 2

**CHECK/MONITORING SHEET FOR THE PROCESS OF AMENDING
THE CONVENTION AND RELATED MANDATORY INSTRUMENTS
(PROPOSAL/DEVELOPMENT)**

Part I – Submitter of proposal (refer to paragraph 3.2.1.1)*

1	<i>Submitted by (document number and submitter)</i>
2	<i>Meeting session</i>
3	<i>Date (date of submission)</i>

Part II – Details of proposed amendment(s) or new mandatory instrument (refer to paragraphs 3.2.1.1 and 3.2.1.2)*

1	<i>Strategic direction</i>
2	<i>Title of the output</i>
3	<i>Recommended type of amendments (MSC.1/Circ.1481) (delete as appropriate)</i> <ul style="list-style-type: none">• Four-year cycle of entry into force• exceptional circumstance
4	<i>Instruments intended for amendment (SOLAS, LSA Code, etc.) or developed (new code, new version of a code, etc.)</i>
5	<i>Intended application (scope, size, type, tonnage/length restriction, service (International/non-international), activity, etc.)</i>
6	<i>Application to new/existing ships</i>
7	<i>Proposed coordinating sub-committee</i>
8	<i>Anticipated supporting sub-committees</i>
9	<i>Time scale for completion</i>
10	<i>Expected date(s) for entry into force and implementation/application</i>
11	<i>Any relevant decision taken or instruction given by the Committee</i>

* Parts I and II should be completed by the submitter of a proposed new amendment, to the fullest extent possible.

Part III – Process monitoring to be completed during the work process at the sub-committee and checked as part of the final approval process by the Committee (refer to paragraph 3.2.1.3)**

1	The sub-committee, at an initial engagement, has allocated sufficient time for technical research and discussion before the target completion date, especially on issues needing to be addressed by more than one sub-committee and for which the timing of relevant sub-committees meetings and exchanges of the result of consideration needed to be carefully examined.	
2	The scope of application agreed at the proposal stage was not changed without the approval of the Committee.	
3	The technical base document/draft amendment addresses the proposal's issue(s) through the suggested instrument(s); where it does not, the sub-committee offers the Committee an alternative method of addressing the problem raised by the proposal.	
4	Due attention has been paid to the <i>Interim guidelines for the systematic application of the grandfather clauses</i> (MSC/Circ.765-MEPC/Circ.315).	
5	All references have been examined against the text that will be valid if the proposed amendment enters into force.	
6	The location of the insertion or modified text is correct for the text that will be valid when the proposed text enters into force on a four-year cycle of entry into force, as other relevant amendments adopted might enter into force on the same date.	
7	There are no inconsistencies in respect of scope of application between the technical regulation and the application statement contained in regulation 1 or 2 of the relevant chapter, and application is specifically addressed for existing and/or new ships, as necessary.	
8	Where a new term has been introduced into a regulation and a clear definition is necessary, the definition is given in the article of the Convention or at the beginning of the chapter.	
9	Where any of the terms "fitted", "provided", "installed" or "installation" are used, consideration has been given to clarifying the intended meaning of the term.	
10	All necessary related and consequential amendments to other existing instruments, including non-mandatory instruments, in particular to the forms of certificates and records of equipment required in the instrument being amended, have been examined and included as part of the proposed amendment(s).	
11	The forms of certificates and records of equipment have been harmonized, where appropriate, between the Convention and its Protocols.	

** Part III should be completed by the drafting/working group that prepared the draft text using "yes", "no" or "not applicable". For the draft amendments to be considered and finalized by sub-committees in plenary within one session, the Secretariat may be requested, when necessary, to complete part III of the check/monitoring sheet after the session, instead of establishing a specific working/drafting group. "Minor corrections" (C/ES.27/D, paragraph 3.2(vi)) may be excluded from application of the provisions for completion of the check/monitoring sheet.

12	It is confirmed that the amendment is being made to a currently valid text and that no other bodies are concurrently proposing changes to the same text.	
13	All entry-into-force criteria (building contract, keel laying and delivery) have been considered and addressed.	
14	Other impacts of the implementation of the proposed/approved amendment have been fully analysed, including consequential amendments to the "application" and "definition" regulations of the chapter.	
15	The amendments presented for adoption clearly indicate changes made with respect to the original text, so as to facilitate their consideration.	
16	For amendments to mandatory instruments, the relationship between the Convention and the related instrument has been observed and addressed, as appropriate.	
17	The related record format has been completed or updated, as appropriate.	

GUIDANCE NOTES FOR COMPLETING THE CHECK/MONITORING SHEET

Part I – Submitter of proposal

This part should be completed by the submitter of a proposed new amendment, to the fullest extent possible.

The original proposal for amendment(s) should be sponsored by, at least, a Contracting Government to the Convention. The Contracting Government (or in the case of a number of Contracting Governments, a nominated lead Contracting Government) should complete part I.

Part II – Details of proposed amendment(s) or of the proposed new mandatory instrument

This part should be completed by the submitter of a proposed new amendment, to the fullest extent possible.

Details of the proposal should be complete and as detailed as possible. If the proposal is related to a casualty, a full explanation of the factors involved or the safety analysis should be appended to the proposal, especially, when the submitter considers a case of "exceptional circumstance", as per MSC.1/Circ.1481. Consideration of the size of the affected fleet or number of affected mariners, or both, should form part of the justification of the proposal.

Part III – Process monitoring to be completed during the work process at the sub-committee and checked as part of the final approval process by the Committee

This part should be completed by the drafting/working group that prepared the draft text. For the draft amendments to be considered and finalized by sub-committees in plenary within one session, the Secretariat may be requested, when necessary, to complete part III of the check/monitoring sheet after the session, instead of establishing a specific working/drafting group. "Minor corrections" (C/ES.27/D, paragraph 3.2(vi)) may be excluded from application of the provisions for completion of the check/monitoring sheet.

This checklist should be completed to the fullest extent possible at each stage of the regulatory project process. Each time the regulatory project receives a set of terms of reference for a correspondence, working or drafting group, the Chair or the Secretariat should review the checklist with the group at the completion of that group's report.

Each process means:

- Initial engagement at the sub-committee (items 1 to 2).
- During the discussion at the sub-committee (items 3 to 6).
- Finalization stage at the sub-committee (items 7 to 16).

The concept is to create a tracking mechanism, by a complete synopsis record of the regulatory process, to assure those delegations unable to participate in the work of working/drafting groups due to personnel and/or time constraints that the strictures of the process method are complied with in accordance with the dictates of the Committee.

ANNEX 3
RECORD FORMAT

The following records should be created and kept updated for each regulatory development.*

The records can be completed by providing references to paragraphs of related documents containing the relevant information, proposals, discussions and decisions.

1	Title (number and title of regulation(s))
2	Origin of the requirement (original proposal document)
3	Main reason for the development (extract from the proposal document)
4	Related output
5	History of the discussion (approval of work programmes, sessions of sub-committees, including CG/DG/WG arrangements)
6	Impact on other instruments (codes, performance standards, guidance circulars, certificates/records format, etc.)
7	Technical background
7.1	<i>Scope and objective (to cross check with items 4 and 5 in part II of the checklist)</i>
7.2	<i>Technical/operational background and rationale (e.g. summary of FSA study, if available, or engineering challenge posed)</i>
7.3	<i>Source/derivation of requirement (non-mandatory instrument, industry standard, national/regional requirement)</i>
7.4	<i>Short summary of requirement (what is the new requirement – in short and lay terms)</i>
7.5	<i>Points of discussions (controversial points and conclusion)</i>

* For the draft amendments to be considered and finalized by sub-committees in plenary within one session, the Secretariat may be requested, when necessary, to complete the records for regulatory development after the session, instead of establishing a specific working/drafting group. "Minor corrections" (C/ES.27/D, paragraph 3.2(vi)) may be excluded from application of the provisions for completion of the records for regulatory development.

4 ALBERT EMBANKMENT
LONDON SE1 7SR
Telephone: +44 (0)20 7735 7611 Fax: +44 (0)20 7587 3210

MSC.1/Circ.1587
17 May 2018

**PROCEDURAL ASPECTS RELATED TO THE DRAFTING OF AMENDMENTS
TO SAFETY-RELATED IMO CONVENTIONS, OTHER THAN
THE 1974 SOLAS CONVENTION, AND RELATED
MANDATORY INSTRUMENTS**

1 The Maritime Safety Committee (the Committee), at its ninety-ninth session (16 to 25 May 2018), following the decision to apply the practice of keeping records for regulatory development and, subsequently, expand the application of the *Guidance on drafting of amendments to the 1974 SOLAS Convention and related mandatory instruments* (MSC.1/Circ.1500) to all safety-related IMO conventions and mandatory instruments under those conventions, approved the Procedural aspects related to the drafting of amendments to safety-related IMO conventions, other than the 1974 SOLAS Convention, and related mandatory instruments, as set out in the annex.

2 Without prejudicing the amendments procedure specified in the respective articles of safety-related IMO conventions and the provisions set out in the *Organization and method of work of the Maritime Safety Committee and the Marine Environment Protection Committee and their subsidiary bodies* (MSC-MEPC.1/Circ.5/Rev.1), the procedural aspects contained in the annex provide relevant guidance for the drafting of amendments to safety-related IMO conventions, other than the 1974 SOLAS Convention, and related mandatory instruments.

3 Contracting Governments/Parties to the safety-related IMO conventions are invited to take into account the procedural aspects set out in the annex, when submitting proposals for amendments to safety-related IMO conventions, other than the 1974 SOLAS Convention, or mandatory instruments related to those conventions; and/or proposals for new outputs in accordance with section 4 of the *Organization and method of work of the Maritime Safety Committee and the Marine Environment Protection Committee and their subsidiary bodies* (MSC-MEPC.1/Circ.5/Rev.1).

4 The Committee and its subsidiary bodies, including working, drafting and intersessional groups, should apply the procedural aspects set out in the annex when preparing draft amendments to safety-related IMO conventions, other than the 1974 SOLAS Convention, and related mandatory instruments, as well as during the approval and adoption stages.

5 Member States and the Committee's subsidiary bodies are invited to bring to the attention of the Committee the results of experience gained from the use of the procedural aspects set out in the annex and to make recommendations for improvements, as appropriate.

ANNEX

PROCEDURAL ASPECTS RELATED TO THE DRAFTING OF AMENDMENTS TO SAFETY-RELATED IMO CONVENTIONS, OTHER THAN THE 1974 SOLAS CONVENTION, AND RELATED MANDATORY INSTRUMENTS

1 Introduction

1.1 This note provides procedural aspects related to the drafting of amendments to safety-related IMO conventions, other than the 1974 SOLAS Convention, and related mandatory instruments.

1.2 These procedural aspects should always be read with reference to the amendment provisions in the relevant articles of safety-related IMO conventions and in conjunction with the *Organization and method of work of the Maritime Safety Committee and the Marine Environment Protection Committee and their subsidiary bodies* (MSC-MEPC.1/Circ.5/Rev.1).

1.3 The present procedural aspects summarize the most common practice for keeping records for regulatory development to safety-related IMO conventions, other than the 1974 SOLAS Convention, and related mandatory instruments.

2 Goal

2.1 The present procedural aspects are meant to ensure that submission and development of new or amended regulations/paragraphs are carried out in an appropriately comprehensive and detailed manner and, in particular, that Contracting Governments/Parties to safety-related IMO conventions, other than the 1974 SOLAS Convention, the Committee and its subsidiary bodies, including working and drafting groups, as well as other interested parties, are provided with appropriate guidance on drafting of amendments to such conventions and related mandatory instruments.

2.2 In order to achieve the above goal, the procedural aspects are based on the following two main principles:

- .1 a systematic control process throughout the different stages of the amendments' development; and
- .2 relevant guidance for drafting amendments.

3 Procedural aspects related to the drafting of amendments and control process

3.1 ***Process for amending safety-related IMO conventions, other than the 1974 SOLAS Convention, and related mandatory instruments (from proposal to adoption)***

3.1.1 At a proposal stage and in addition to the information to be provided in proposals for new outputs (see annex 1 to the *Organization and method of work of the Maritime Safety Committee and the Marine Environment Protection Committee and their subsidiary bodies* (MSC-MEPC.1/Circ.5/Rev.1)), where possible, the following elements should be addressed when considering proposals for a new output that may require the preparation of amendments to safety-related IMO conventions, other than the 1974 SOLAS Convention, and/or mandatory instruments related to those conventions:

- .1 ship type(s) to which the proposed amendment(s) is/are expected to apply (e.g. scope, size, type, tonnage/length restriction; service areas (international/non-international); activities (e.g. supporting diving activities));
- .2 the extent of application to existing ships,¹ along with any relevant safety measures that may be applied to existing ships;
- .3 the intended instrument(s) that should be amended (i.e. the conventions and associated mandatory instruments); and
- .4 the use of the check/monitoring sheet (refer to paragraph 3.1.3.14 below).

3.1.2 During the consideration of new outputs, and in addition to the actions to be taken based on MSC-MEPC.1/Circ.5/Rev.1, the Committee should consider the elements listed below and, in this respect, should give clear instructions to the relevant technical subsidiary body/bodies (i.e. sub-committees, including their working/drafting/intersessional groups, as well as those reporting directly to the Committee), as may be applicable:

- .1 target completion date at the sub-committee level;
- .2 expected date(s) of entry-into-force and implementation/application date(s) (e.g. possible phase-in arrangement for existing ships) of the amendment(s) or of the new requirement(s) to be developed; and
- .3 scope of application of the proposed amendment(s) or new requirement(s), along with the instrument(s) which would be required to be amended/developed. In this regard, the following should be taken into consideration:
 - .1 if a comprehensive revision to an instrument is required, a decision should be taken whether to revise the existing instrument or create a new version, which may co-exist with the existing instrument; and
 - .2 if the instrument to be amended has different versions, a decision should be made whether older versions of the instrument should also be revised, especially when considering amendments to operational requirements which are likely to result in the revision to all versions of the instrument.

3.1.3 At a subsequent processing stage, but before the conclusion of the approval for adoption, each allocated sub-committee should ensure that:

- .1 at an initial engagement, sufficient time is allocated for technical research and discussion before the target completion date, especially when the issue is needed to be addressed by more than one sub-committee where timing of meetings of relevant sub-committees and exchanges of the result of considerations need to be carefully examined;
- .2 the intended scope of application agreed by the Committee (refer to paragraph 3.1.2 above) is not changed without approval of the Committee,

¹ Refer to the *Interim guidelines for the systematic application of the grandfather clauses* (MSC/Circ.765-MEPC/Circ.315).

- providing clear justification for such change (e.g. in case of unintended omissions);
- .3 the technical base document or draft amendment addresses the proposal's issue(s) through the suggested instrument(s) and, if not, an alternative method is offered to the Committee for addressing the problem raised by the proposal;
 - .4 if application to existing ships is agreed by the Committee under paragraph 3.1.1.2 above, due attention should be paid to the *Interim guidelines for the systematic application of the grandfather clauses* (MSC/Circ.765-MEPC/Circ.315) and, as appropriate, to the *Unified interpretation of the date of completion of the survey and verification on which the certificates are based* (MSC-MEPC.5/Circ.3);
 - .5 all references have been examined against the text that would be valid if the proposed amendment enters into force;
 - .6 there are no inconsistencies between the scope of application of a particular technical regulation and the application statement of the relevant chapter, and application is specifically addressed for existing and/or new ships, as necessary;
 - .7 if a new term is introduced in a regulation and a clear definition is necessary, the definition is given in the relevant article of the convention or at the beginning of the chapter, as appropriate;
 - .8 when terms such as "fitted", "provided", "installed" or "installation" are used, a clear understanding of the intended meaning of the term is provided;
 - .9 all necessary related and consequential amendments to other existing instruments, including non-mandatory instruments, in particular the forms of certificates and records of equipment required in the instrument being amended, have been examined and included as a part of the amendment(s);
 - .10 the forms of certificates are harmonized, where appropriate, between the convention and its protocol(s);
 - .11 draft amendments are presented for consideration, as far as practically possible, as tracked changes within the context of the relevant provisions to be amended (refer to section 3.3 below);
 - .12 due attention is paid to the "application" and "definition" regulations/ paragraphs of the chapter where these are likely to affect or be affected by the proposed amendments;
 - .13 when preparing amendments to mandatory instruments, the relationship between the convention and the instrument is observed;

- .14 the check/monitoring sheet given in annex 1 is observed and completed throughout the progress at each one of the above stages. In this respect, it is intended that:
 - .1 parts I and II should be completed by the submitter of a proposal for a new output, as far as possible, as an annex to the submission document (refer to paragraph 3.1.1.4 above); and
 - .2 part III should be completed by the drafting or working group that prepares the draft amendment(s);²
- .15 the final draft text of proposed amendments to the Convention or any related mandatory instrument is reviewed by either a drafting group or by a working group² to properly address the issues listed in part III of the check/monitoring sheet, as given in paragraph 3.2.2 below;
- .16 the check/monitoring sheet is presented along with the draft amendments submitted for approval; and
- .17 the record format given in annex 2 is completed³ by the drafting or working group that prepares the draft amendment(s).²

3.1.4 At the approval and adoption stages:

- .1 the Committee should carefully review the draft amendments submitted for approval, using the associated check/monitoring sheet prepared by the subsidiary body. In doing so, issues requiring further drafting consideration may be identified. Under those circumstances, the Committee may consider instructing the drafting group on amendments to review the draft amendments and the associated check/monitoring sheet before approval of the related amendments, taking into account the information contained in the related record format; and
- .2 the Secretariat should:
 - .1 ensure that the draft amendments submitted for approval, as well as those contained in the annexes of the Committee's report after approval, are presented in tracked changes, as appropriate (refer to section 3.3 below);
 - .2 prepare the appropriate text of draft amendments without tracked changes for circulation to all Members of the Organization and all Contracting Governments/Parties to the convention after approval, in accordance with the relevant article of the convention;

² For the draft amendments to be considered and finalized by sub-committees in plenary within one session, the Secretariat may be requested, when necessary, to complete part III of the check/monitoring sheet and the records for regulatory development after the session, instead of establishing a specific working/drafting group. "Minor corrections" (C/ES.27/D, paragraph 3.2(vi)) may be excluded from application of the provisions for completion of the check/monitoring sheet and the records for regulatory development.

³ The information should be completed in the module "Development of amendments to the 1974 SOLAS Convention and related mandatory instruments" of GISIS, when available.

- .3 prepare documents containing the text of the approved draft amendments without tracked changes, together with the draft resolution(s), for submission to the session of the Committee that will consider the amendments for adoption;
- .4 prepare a working paper consolidating all draft amendments submitted for adoption with tracked changes, including proposals for modifications or editorial improvements, if any, as well as notes and comments, as appropriate (refer to section 3.3 below). This document should be made available in IMODOCS as soon as possible after the deadline for commenting documents and should be used as the base document for the preliminary consideration by the expanded Committee and final revision by the drafting group on amendments;
- .5 ensure that, after adoption, the final text of the amendments which are contained in the annexes of the Committee's report (i.e. the MSC resolutions) is presented without tracked changes;
- .6 prepare the authentic text of the adopted amendments after adoption, when requested, and make it available on IMODOCS;⁴ and
- .7 keep the related record format updated in respect to relevant decisions taken at the sub-committee or committee level.

3.2 Drafting group arrangements

3.2.1 Drafting groups have a relevant role in the amendment control process. Although drafting groups cannot change the essence of the amendments, they should ensure that the drafting of amendments is carried out in accordance with the present procedural aspects. Therefore, these procedural aspects should be included as a standing reference in the terms of reference of these groups, along with references for completion of the check/monitoring sheet and record format, set out in annexes 1 and 2, respectively.

3.2.2 The first stage of the engagement in the control process of drafting works should be undertaken by a drafting group or by a working group of the subsidiary body or by those reporting directly to the Committee.⁵ In doing so, the check/monitoring sheet set out in annex 1 should be observed and completed before submitting the draft amendments for approval.

3.2.3 At the approval stage of amendments, the Committee should carefully review the draft amendments submitted for approval, along with the related check/monitoring sheet (refer to paragraph 3.1.4.1).

⁴ The whole process of the production of certified true copies, in all cases, should not take longer than 100 days for non-bulky documents (those containing six pages or fewer) and 160 days for bulky documents (those containing more than six pages) after the date of adoption of the amendment.

⁵ For the draft amendments to be considered and finalized by sub-committees in plenary within one session, the Secretariat may be requested, when necessary, to complete part III of the check/monitoring sheet and the records for regulatory development after the session, instead of establishing a specific working/drafting group. "Minor corrections" (C/ES.27/D, paragraph 3.2(vi)) may be excluded from application of the provisions for completion of the check/monitoring sheet and the records for regulatory development.

3.2.4 Depending upon the findings in the check/monitoring sheet, the Committee may consider tasking the drafting group established for reviewing the amendments submitted for adoption (refer to paragraph 3.2.6 below) to review the draft amendments submitted for approval and the related check/monitoring sheet, including the information contained in the related record format.

3.2.5 After the approval of draft amendments by the Committee, the Secretariat should review the approved draft amendments from the drafting and editorial point of view. Any findings by the Secretariat should be submitted to the session of the Committee that would adopt the amendments as part of the working paper consolidating the amendments, comments and proposals for modifications, which would be prepared in advance by the Secretariat (see paragraph 3.1.4.2.4).

3.2.6 At the adoption stage, the above-mentioned working paper should be used as the basis document for consideration of the draft amendments by the expanded Committee and by the drafting group that would conduct the final review of the draft amendments, along with any comments provided in any of the documents submitted to that session for consideration.

3.3 Use of tracked changes

3.3.1 The use of tracked changes during the preparation, approval and adoption of draft amendments may facilitate the consideration of proposed amendments. It may also assist the work of translators and reduce the number of misinterpretations.

3.3.2 Tracked changes should mainly be used, as far as practically possible, for draft amendments to the text of existing regulations, paragraphs or tables, in order to easily identify the changes proposed with respect to the original text. In this respect, only the relevant part(s) of the original text should be reproduced.

3.3.3 For insertions of new regulations, paragraphs or tables, or deletion of existing ones, the use of tracked changes may not be practical.

3.3.4 Tracked changes should be created using "strikeout" for deleted text and "grey shading" to highlight all modifications and new insertions, including deleted text (i.e. not using the track changes function of Microsoft Word), in order to ensure that such changes are not lost during further editorial work (e.g. cut and paste).

3.4 Referencing other instruments

3.4.1 When referencing other mandatory/non-mandatory instruments in a mandatory instrument, the *Guidelines on methods for making reference to IMO and other instruments in IMO conventions and other mandatory instruments*, as set out in the annex to resolution A.911(22) on *Uniform wording for referencing IMO documents*, should be applied.

3.4.2 The above Guidelines provide standard text for references for inclusion in new IMO conventions and other mandatory instruments relating to maritime safety and pollution prevention and in future amendments to existing conventions and other instruments, in order to ensure that, where reference is made to IMO conventions and other instruments, a uniform wording is used. This is to indicate clearly the legal status of the instrument in question after the IMO body concerned has decided on the status. Therefore, references to standards which are intended to be mandatory should not be included as a footnote. They should instead be included explicitly in the text of relevant regulations/paragraphs or amendments.

3.5 Status of footnotes

3.5.1 The *Guidelines on methods for making reference to IMO and other instruments in IMO conventions and other mandatory instruments*, adopted by resolution A.911(22), reflect that standards and specifications referred to in footnotes, as well as guidelines and recommendations, should not appear in the authentic text of mandatory instruments but may be included in sales publications and updated by the Secretariat as necessary when a new edition of the relevant publication is prepared.

3.5.2 For future amendments to the Convention or related mandatory instruments, text intended to be a mandatory part of the instrument should not be included in a footnote.

3.6 Human element

Reference is made to paragraph 4.27 of the *Organization and method of work of the Maritime Safety Committee and the Marine Environment Protection Committee and their subsidiary bodies* (MSC-MEPC.1/Circ.5/Rev.1), which states that, recognizing the human factor as an integral part of any effort to enhance maritime safety, maritime security or protection of the marine environment, the subsidiary bodies should consider the human factor whenever new requirements are developed and existing requirements are reviewed, by taking into account the human element principles, as set out in the annex to resolution A.947(23) on *Human element vision, principles and goals for the Organization*.

ANNEX 1

**CHECK/MONITORING SHEET FOR THE PROCESSING OF AMENDMENTS TO
SAFETY-RELATED IMO CONVENTION, OTHER THAN THE 1974 SOLAS
CONVENTION, AND RELATED MANDATORY INSTRUMENTS
(PROPOSAL/DEVELOPMENT)**

Part I – Submitter of proposal (refer to paragraph 3.1.1)*

1	<i>Submitted by (document number and submitter)</i>
2	<i>Meeting session</i>
3	<i>Date (date of submission)</i>

Part II – Details of proposed amendment(s) or new mandatory instrument (refer to paragraphs 3.1.1 and 3.1.2)*

1	<i>Strategic direction</i>
2	<i>Title of the output</i>
3	<i>Instruments intended for amendment (i.e. the conventions and relevant mandatory instruments) or developed (new code, new version of a code, etc.)</i>
4	<i>Intended application (scope, size, type, tonnage/length restriction, service (international/non-international), activity, etc.)</i>
5	<i>Application to new/existing ships</i>
6	<i>Proposed coordinating sub-committee</i>
7	<i>Anticipated supporting sub-committees</i>
8	<i>Timescale for completion</i>
9	<i>Expected date(s) for entry into force and implementation/application</i>
10	<i>Any relevant decision taken or instruction given by the Committee</i>

* Parts I and II should be completed by the submitter of a proposed new amendment, to the fullest extent possible.

Part III – Process monitoring to be completed during the work process at the sub-committee and checked as part of the final approval process by the Committee (refer to paragraph 3.1.3)**

1	The sub-committee, at an initial engagement, has allocated sufficient time for technical research and discussion before the target completion date, especially on issues needing to be addressed by more than one sub-committee and for which the timing of relevant sub-committees meetings and exchanges of the result of consideration needed to be carefully examined.	
2	The scope of application agreed at the proposal stage was not changed without the approval of the Committee.	
3	The technical base document/draft amendment addresses the proposal's issue(s) through the suggested instrument(s); where it does not, the sub-committee offers the Committee an alternative method of addressing the problem raised by the proposal.	
4	Due attention has been paid to the <i>Interim guidelines for the systematic application of the grandfather clauses</i> (MSC/Circ.765-MEPC/Circ.315).	
5	All references have been examined against the text that will be valid if the proposed amendment enters into force.	
6	There are no inconsistencies in respect of scope of application between the technical regulation and the application statement of the relevant chapter, and application is specifically addressed for existing and/or new ships, as necessary.	
7	Where a new term has been introduced into a regulation and a clear definition is necessary, the definition is given in the article of the convention or at the beginning of the chapter.	
8	Where any of the terms "fitted", "provided", "installed" or "installation" are used, consideration has been given to clarifying the intended meaning of the term.	
9	All necessary related and consequential amendments to other existing instruments, including non-mandatory instruments, in particular to the forms of certificates and records of equipment required in the instrument being amended, have been examined and included as part of the proposed amendment(s).	
10	The forms of certificates and records of equipment have been harmonized, where appropriate, between the convention and its protocol(s).	
11	It is confirmed that the amendment is being made to a currently valid text and that no other bodies are concurrently proposing changes to the same text.	

** Part III should be completed by the drafting/working group that prepared the draft text using "yes", "no" or "not applicable". For the draft amendments to be considered and finalized by sub-committees in plenary within one session, the Secretariat may be requested, when necessary, to complete part III of the check/monitoring sheet after the session, instead of establishing a specific working/drafting group. "Minor corrections" (C/ES.27/D, paragraph 3.2(vi)) may be excluded from application of the provisions for completion of the check/monitoring sheet.

12	Other impacts of the implementation of the proposed/approved amendment have been fully analysed, including consequential amendments to the "application" and "definition" regulations of the chapter.	
13	The amendments presented for adoption clearly indicate changes made with respect to the original text, so as to facilitate their consideration.	
14	For amendments to mandatory instruments, the relationship between the convention and the related instrument has been observed and addressed, as appropriate.	
15	The related record format has been completed or updated, as appropriate.	

GUIDANCE NOTES FOR COMPLETING THE CHECK/MONITORING SHEET

Part I – Submitter of proposal

This part should be completed by the submitter of a proposed new amendment, to the fullest extent possible.

The original proposal for amendment(s) should be sponsored by, at least, a Contracting Government/Party to the convention. The Contracting Government/Party (or in the case of a number of Contracting Governments/Parties, a nominated lead Contracting Government/Party) should complete part I.

Part II – Details of proposed amendment(s) or of the proposed new mandatory instrument

This part should be completed by the submitter of a proposed new amendment, to the fullest extent possible.

Details of the proposal should be complete and as detailed as possible. If the proposal is related to a casualty, a full explanation of the factors involved or the safety analysis should be appended to the proposal. Consideration of the size of the affected fleet or number of affected mariners, or both, should form part of the justification of the proposal.

Part III – Process monitoring to be completed during the work process at the sub-committee and checked as part of the final approval process by the Committee

This part should be completed by the drafting/working group that prepared the draft text. For the draft amendments to be considered and finalized by sub-committees in plenary within one session, the Secretariat may be requested, when necessary, to complete part III of the check/monitoring sheet after the session, instead of establishing a specific working/drafting group. "Minor corrections" (C/ES.27/D, paragraph 3.2(vi)) may be excluded from application of the provisions for completion of the check/monitoring sheet.

This check sheet should be completed to the fullest extent possible at each stage of the regulatory project process. Each time the regulatory project receives a set of terms of reference for a correspondence, working or drafting groups, the Chair or the Secretariat should review the check sheet with the group at the completion of that group's report.

Each process means:

- Initial engagement at the sub-committee (items 1 to 2)
- During the discussion at the sub-committee (items 3 to 5)
- Finalization stage at the sub-committee (items 6 to 15)

The concept is to create a tracking mechanism, by a complete synopsis record of the regulatory process, to assure those delegations unable to participate in the work of working/drafting groups due to personnel and/or time constraints, that the strictures of the process method are complied with in accordance with the dictates of the Committee.

ANNEX 2

RECORD FORMAT

The following records should be created and kept updated for each regulatory development.*

The records can be completed by providing references to paragraphs of related documents containing the relevant information, proposals, discussions and decisions.

1	Title (number and title of regulation(s))
2	Origin of the requirement (original proposal document)
3	Main reason for the development (extract from the proposal document)
4	Related output
5	History of the discussion (approval of work programmes, sessions of sub-committees, including CG/DG/WG arrangements)
6	Impact on other instruments (codes, performance standards, guidance circulars, certificates/records format, etc.)
7	Technical background
7.1	<i>Scope and objective (to cross check with items 4 and 5 in part II of the check sheet)</i>
7.2	<i>Technical/operational background and rationale (e.g. summary of FSA study, if available, or engineering challenge posed)</i>
7.3	<i>Source/derivation of requirement (non-mandatory instrument, industry standard, national/regional requirement)</i>
7.4	<i>Short summary of requirement (what is the new requirement – in short and lay terms)</i>
7.5	<i>Points of discussions (controversial points and conclusion)</i>

* For the draft amendments to be considered and finalized by sub-committees in plenary within one session, the Secretariat may be requested, when necessary, to complete the records for regulatory development after the session, instead of establishing a specific working/drafting group. "Minor corrections" (C/ES.27/D, paragraph 3.2(vi)) may be excluded from application of the provisions for completion of the records for regulatory development.

4 ALBERT EMBANKMENT
LONDON SE1 7SR
Telephone: +44 (0)20 7735 7611 Fax: +44 (0)20 7587 3210

MSC.1/Circ.1588
11 June 2018

CARRIAGE OF DANGEROUS GOODS

INTERNATIONAL MARITIME DANGEROUS GOODS (IMDG) CODE

REVISED EMERGENCY RESPONSE PROCEDURES FOR SHIPS CARRYING DANGEROUS GOODS (EMS GUIDE)

1 The Maritime Safety Committee, at its ninety-ninth session (16 to 25 May 2018), approved the *Revised Emergency Response Procedures for Ships Carrying Dangerous Goods (EmS Guide)*, set out in the annex, which had been prepared by the Sub-Committee on Carriage of Cargoes and Containers (CCC) at its fourth session (11 to 15 September 2017), and finalized by the Sub-Committee's Editorial and Technical Group.

2 Member States are invited to bring the annexed Revised EmS Guide to the attention of all parties concerned, taking into account the voluntary application date of 1 January 2019 of amendments (39-18) to the IMDG Code, pending its envisaged mandatory entry-into-force date of 1 January 2020.

3 This circular supersedes MSC/Circ.1025, as amended by MSC.1/Circ.1025/Add.1, MSC.1/Circ.1262, MSC.1/Circ.1360, MSC.1/Circ.1438, MSC.1/Circ.1476 and MSC.1/Circ.1522.

ANNEX

**Revised Emergency Response Procedures for Ships Carrying
Dangerous Goods (EmS Guide)**

Contents

	<i>Page</i>
Foreword	2
Preamble	3
How to use this Guide	4
Fire	
Introduction to the Emergency Schedules for FIRE	5
General guidelines for FIRE	15
Emergency Schedules for FIRE	16
Spillage	
Introduction to the Emergency Schedules for SPILLAGE	28
General guidelines for SPILLAGE	38
Emergency Schedules for SPILLAGE	39
Index	68

Foreword

This EmS Guide contains guidance on Emergency Response Procedures for Ships Carrying Dangerous Goods including the Emergency Schedules (EmS) to be followed in case of incidents involving dangerous substances, materials or articles, or harmful substances (marine pollutants), regulated under the International Maritime Dangerous Goods Code (IMDG Code).

This edition takes into account the amendment 39-18 to the IMDG Code. The EmS Guide will be further amended as and when necessary to reflect amendments made to the IMDG Code.

Preamble

The purpose of this Guide is to provide guidance for dealing with fires and spillages (leakages) on board ships involving the dangerous goods listed in the International Maritime Dangerous Goods Code (IMDG Code).

In accordance with the International Safety Management Code (ISM Code), all ships, and the companies responsible for their operation, are required to maintain a Safety Management System (SMS). Within the SMS, procedures for responding to potential shipboard emergencies are required. This Guide is intended to assist shipowners, ship operators and other parties concerned with developing such emergency response procedures, which should be integrated into the ship's contingency plan.

In November 1997, the IMO Assembly adopted resolution A.852(20) on *Guidelines for a structure of an integrated system of contingency planning for shipboard emergencies*, which were further revised by resolution A.1072(28) in December 2013. This Guide should be integrated into Module IV on Response actions, as contained in paragraph 3.2.4.6 of the latter resolution, for cargo-related incidents.

In the event of a fire or spillage incident, initial actions should be carried out in accordance with the shipboard emergency plan. Where dangerous goods are involved, the responses in the emergency plan should be based on this Guide for specific dangerous goods having regard to, inter alia, the type of ship, the quantity and type of packaging of the dangerous goods and whether the goods are stowed on or under deck.

How to use this Guide

1 The guidance contained in this Guide is intended for fire and/or spillage (leakage) emergencies on board a ship involving packaged dangerous goods transported in accordance with the provisions of the IMDG Code. The Guide should not be used for emergencies involving bulk cargoes or any other fire and/or spillage on board a ship which does not involve packaged dangerous goods as cargo.

2 This guidance is for shipboard use where master and crew have to respond to a fire or a spillage without external assistance. The recommendations are based on the fire safety provisions contained in chapter II-2 of the 1974 Safety of Life at Sea Convention (SOLAS), as amended, and the provisions of the IMDG Code. The guidance should be integrated into the contingency plan for shipboard emergencies, which should be specific to the individual ship and should take into account the equipment on board.

3 There are international and national requirements for ships to contact or report to the nearest coastal State when an incident takes place involving the loss or likely loss of packaged dangerous goods (see Reporting Procedures). Contacting shore-based experts at an early stage irrespective of how insignificant the incident may seem to be is recommended. However, it should be noted that shore-based personnel or rescue/ coastguard experts may use different techniques to fight a fire or to deal with spillage on board a ship.

4 In this Guide, there is separate advice for fire and spillage emergencies which should be consulted accordingly.

5 This Guide should be used as follows:

- .1 for fire and spillage, read and incorporate into the ship's training regime the INTRODUCTIONS to the emergency schedules, before any emergency occurs;
- .2 in the event of an emergency involving packaged dangerous goods, consult the GENERAL GUIDELINES as a first step; and
- .3 obtain detailed advice for the specific cargo(es) involved by reading the relevant EMERGENCY SCHEDULE(S) (EmS) for the cargo(es).

Fire

Introduction to the Emergency Schedules for FIRE

1 Be prepared

1.1 Preventing a fire from occurring is the most important part of a shipboard safety programme. However, once a fire has started, a well-trained crew is the best defence for bringing the fire under control. Given the complexity of extinguishing a fire involving dangerous goods, it is essential that the advice in this Guide be incorporated into the ship's training regime so that the crew will be able to respond to a fire casualty in a timely and effective manner.

1.2 This Guide should be integrated into a Safety Management System (SMS). Procedures contained in the shipboard emergency plan should be tailored to the individual ship.

1.3 The fire-fighting procedures within the EmS SCHEDULES are different for "on deck" and "under deck" stowage. For specific ship types (e.g. hatchless container ships) or cargo holds (e.g. open vehicle decks of ferries), these two procedures have to be assigned specifically to the individual ship.

1.4 Given the toxic nature of some of the dangerous goods involved, accommodation spaces should be protected from fire and smoke as far as possible (e.g. water spray). Therefore, the ventilation systems for working and living spaces should be shut off, closed and secured to reduce the possibility of vapours, dusts and gases penetrating these spaces. In some instances, it may be necessary to turn the ship's accommodation spaces upwind, if possible.

1.5 The safety of fire-fighting personnel is most important. Use of appropriate protective clothing (i.e. a firefighter's outfit when dealing with a fire) and self-contained breathing apparatus, to protect skin and lungs from toxic and/or corrosive liquids, vapours, dusts and gases, is essential. This equipment should be suitable for each individual member of the fire-fighting team, as working with such equipment requires a high level of fitness and training. It should be kept in mind that even a weak acute illness may interfere with a crew member's fitness. In addition, pregnant crew members should not be exposed to dangerous vapours.

1.6 It is also essential to ensure that there is always an escape route for fire-fighting personnel despite the limitations due to narrow exit paths and the danger of falling overboard.

2 Identification of the dangerous good(s) involved

2.1 It is essential to identify the dangerous good(s) involved in the fire in order that the specific EmS FIRE SCHEDULE(S) for the cargo(es) may be consulted and appropriate action taken. This is important because some dangerous goods are incompatible with some fire-fighting media and could exacerbate the situation (e.g. use of a water-based extinguishing medium on water-reactive cargoes).

2.2 An identification number with four digits preceded by the letters "UN" is assigned to all dangerous goods. From the UN Number, it is possible to find the appropriate EmS FIRE SCHEDULE. The Dangerous Goods List in part 3, chapter 3.2 of the IMDG Code contains the names and the UN numbers, as well as the EmS SCHEDULE NUMBERS. The special Dangerous Goods Manifest and the detailed Stowage Plan required by SOLAS regulation VII/4.2 will also contain the proper shipping name and UN number of the dangerous good(s) concerned. Packages will usually be labelled as well.

2.3 Specific information as to properties of dangerous goods may also be found in the Dangerous Goods List in the IMDG Code. Dangerous goods are classified and labelled according to their hazards. Labels and marks on packages provide a warning of the general risks to be encountered. Personnel should understand the labelling system.

2.4 Emergency preparedness should form part of the ship's SMS as required by the ISM Code. Prepared information can reduce errors during a fire emergency. Therefore, it is recommended that the EmS SCHEDULE(S) be identified and included on the Dangerous Goods Manifest and Stowage Plan recording the stowage position of the cargo. That will enable key members of the crew to know in advance which emergency procedures could be necessary. In the event of a fire, the allocation of a specific EmS FIRE SCHEDULE via identification of cargo via the UN number takes time and is open to error, especially in mixed cargoes in one container. Furthermore, some fire-fighting procedures may require specific media and operations could be affected by the stowage location of such media. The advice given in the EmS FIRE SCHEDULE should be directly usable based on the stowage information, without time-consuming identification and location of the cargo involved.

3 Cool and suffocate

3.1 In general, fires require heat (energy) and oxygen to start burning. Only a limited number of chemicals do not need oxygen from the air. Therefore, the aim of fire fighting is to exclude oxygen and to cool the cargo(es). On board ship, this is generally carried out by using water spray or gas extinguishing systems.

3.2 Some burning cargoes will need special fire-fighting media (like dry inert material) to suffocate the fire. In such circumstances, normal fire-fighting procedures are often impracticable, and concentrating on cooling nearby cargo and ship structures is recommended in such cases.

3.3 Firefighters should be made aware of the hazards of opening doors of an over-heated space or freight container which is suspected of containing cargo on fire. There may be a lack of oxygen inside and fresh air from outside the space may instantly start a fire, and cause a flashback that could injure the firefighters. Cool down the container first!

4 Seek advice

4.1 Expert advice should be sought irrespective of how insignificant the fire may seem to be when dealing with dangerous goods fires. Such advice could be given by:

- .1 ship operating companies (e.g. designated persons);
- .2 emergency information centres (such as CHEMTREC in the USA);
- .3 specialized agencies;
- .4 professional responders;
- .5 port State authorities;
- .6 coastguard;
- .7 fire brigades; and
- .8 manufacturers of the products.

5 Evacuation

Within some EmS FIRE SCHEDULES the phrase "Sudden or short-term events (e.g. explosions) may endanger the safety of the ship" or the phrase "The danger of uncontrolled spread of fire should be considered" has been introduced. Depending on the type of ship and on the volume of dangerous goods allocated to this specific FIRE SCHEDULE, it may be necessary to consider abandoning the ship at an early stage. In this case, the master should be aware of the hazard and should decide whether the ship requires assistance.

6 Fire-fighting media

6.1 Water

6.1.1 Water is the obvious fire-fighting medium at sea and is recommended for most fires involving dangerous goods. However, it should be noted that shore-based firefighters may use a different medium.

6.1.2 When water is applied to a burning cargo, the temperature is reduced and the fire will be extinguished when the temperature drops below the ignition point. However, water is not suitable to extinguish all fires involving dangerous goods. Different fire-fighting media should be used if so indicated on the specific EmS FIRE SCHEDULE.

6.1.3 If the fire is under deck, consideration should be given to the stability of the ship when flooding the hold with water.

6.1.4 Some dangerous goods will react chemically with water, producing flammable and/or toxic gases. The most effective way to extinguish a fire involving these dangerous goods is to smother them with a dry inert powdered material. However, the availability of suitable inert material on board is limited. It may also be dangerous to approach the fire in order to use inert material properly. Consequently, the most appropriate method of extinguishing the fire may be to use copious quantities of water. This would have an overall cooling effect on the fire even though the water may react with the dangerous goods involved.

6.1.5 Ships are equipped with a number of dual-purpose spray/jet nozzles as required by SOLAS. Most EmS FIRE SCHEDULES recommend that the nozzles be set to spray when used to fight fires. Water spray may also be achieved by using water jets from some distance. This method of producing water spray is generally recommended. However, it is dangerous to direct a water jet onto the fire at close range because this could result in the spread of burning material.

6.1.6 The term "copious quantities of water" used within the EmS FIRE SCHEDULES refers to the minimum total quantities of water provided for optimal fire fighting using four jets of water, as required by SOLAS regulation II-2/10. The master and crew should know the practical limitations that may be encountered at specific stowage locations in this respect.

6.1.7 Following the advice "use copious quantities of water" or "water spray from as many hoses as possible" may interfere with the safety of the ship with regard to the ship's stability. Stress forces on the hull due to increased quantities of water in the ship should be considered.

6.2 Fixed gas fire-extinguishing systems

6.2.1 If a fixed gas fire-extinguishing system is used for incidents under deck, all hatches and vent dampers should be closed and ventilation shut off before the system is activated. If smoke is seen coming from around the hatches, the leaks should be sealed with any suitable material available.

6.2.2 The majority of the fixed gas fire-extinguishing systems use carbon dioxide (CO₂), but some use nitrogen (N₂) as the extinguishing medium. The instructions on board should be followed. The fire control plan will sometimes specify a given volume of gas to be applied to a given space. No advantage will be gained by exceeding this volume of gas where burning dangerous goods are involved.

6.2.3 It is important to realize that it will take an appreciable time for the space to cool after the fire has been extinguished. Therefore it would be extremely dangerous to reopen the hatches since the extinguishing gas would escape and air would enter the space again, thus allowing the fire to reignite. The ship's onboard instructions for such cases should be followed.

6.2.4 Fixed gas fire-extinguishing systems are not effective against all fires. EmS FIRE SCHEDULES may contain specific information in this regard.

6.3 Fixed pressure water spraying systems

6.3.1 In some ships (e.g. ro-ro ships and car ferries), some cargo spaces may be fitted with a water drencher or spray system instead of a fixed gas fire-extinguishing system. There will be instructions on board which should be followed.

6.3.2 A closed cargo space should be ventilated to clear it of smoke and toxic gases after the fire has been extinguished and the space has cooled. The ventilation equipment should be of a certified safe type for smoke removal. Evidence that the space is cooling down can be obtained by monitoring adjacent bulkheads and decks. Thereafter, a fire-fighting team should look for any small remaining fires and inspect the surrounding cargo. After the fire has been extinguished, the cargo should be kept under surveillance until its normal temperature is reached.

6.4 Foam

In general, foam is an effective fire-fighting medium for fires involving flammable liquids. The foam forms a layer on the liquid thereby excluding oxygen and reducing heat. However, it is less effective on solid substances on fire. Most foams contain water and should not be used on fires where the use of water is restricted because of adverse chemical reaction.

6.5 Dry chemicals

Dry chemicals may be an effective extinguishing medium for fires involving water-reactive substances and metals. The dry chemical should not react with the dangerous goods involved in the fire. Some dangerous goods require a specific dry chemical to extinguish a fire.

7 Dangerous goods exposed to fire

7.1 Rupture and cooling

7.1.1 Where possible, packages should be removed from the vicinity of the fire. In general, heated material will expand, thus needing more volume and creating pressure in the package. This will affect the integrity of the package which could lead to rupture and dispersal of the contents. Effective cooling can lower the possibility of rupture.

7.1.2 Where there is a danger that heat will have already started to cause a chemical or physical change to the dangerous substance, packages should not be moved. Care should always be exercised, for example, with those substances liable to polymerize, as this reaction may continue for a long time after the removal of the heat source. Provided no discharge or pumping overboard problem arises, cooling should continue for many hours after the fire has been extinguished. After heat evolution has ceased, cooling with water may be stopped. A careful watch should be kept on the stability of the ship.

7.1.3 The EmS FIRE SCHEDULES advise that a number of dangerous goods should be removed or jettisoned if there is a likelihood of their involvement in a fire. However, where full or nearly full cargo transport units are involved, such guidance may be impractical. In that case, the advice should be taken to indicate that the goods are particularly dangerous. Personnel on board should fight the fire and cool nearby cargo as far as possible. It should be borne in mind that some heated dangerous goods may have already damaged the packaging or may explode during handling. Consequently, moving or jettisoning burning cargo should only be attempted with utmost caution.

7.2 Spillage

7.2.1 It should be remembered that leakage of dangerous goods can be very dangerous for the crew and for the ship. Fire and explosion can rupture nearby packages or tanks, creating a spillage.

7.2.2 If a leak is discovered, the hazards associated with that leak should be ascertained immediately. In cases involving leaks of flammable liquids or flammable gases (class 3 and class 2.1 labels respectively), the crew should withdraw to a well-protected position. Air-vapour and air-gas mixtures are liable to explode and such an explosion may injure crew members and damage the ship.

7.2.3 Many toxic gases are odourless and colourless. A number of liquids will produce toxic vapours if exposed to heat. In an emergency, the ship should be manoeuvred to keep the bridge, living quarters and crew upwind as far as possible.

7.2.4 The EmS SPILLAGE SCHEDULES should be consulted when dealing with a leakage.

8 Personal protection

8.1 Ship's personnel

8.1.1 Many vapours and gases of dangerous goods produced by a fire are hazardous to health. In the case of fire, the use of a firefighter's outfit and self-contained breathing apparatus is essential. Only trained personnel should use this equipment, which should be well maintained. Particular attention should be given to ensuring that toxic vapours or fumes do not penetrate occupied areas of the ship (e.g. bridge, living quarters, machinery spaces, working areas, etc.).

8.1.2 According to the ship's fire emergency plan, ventilation systems to living and working spaces should be shut off, closed and secured to reduce the possibility of vapours, dusts and gases from penetrating these areas.

8.2 Fire-fighting team

8.2.1 Chapter II-2 of SOLAS requires firefighter's outfits, full chemical protective suits and self-contained breathing apparatus to be readily available on board. Masters are reminded that personnel will need regular training in the use of self-contained breathing apparatus and that special attention should be given to ensure that face masks fit satisfactorily at all times.

8.2.2 Self-contained breathing apparatus is essential for fire fighting because dangerous goods on fire produce various substances hazardous to health. Handling water jets from some distance or cooling of heated cargo may not require the use of self-contained breathing apparatus. However, decisions not to use self-contained breathing apparatus should be undertaken carefully and on a case-by-case basis.

8.2.3 Fire-fighting outfits offer only limited protection from dangerous goods. Fire-fighting outfits are not chemical suits. Chemical protective clothing is designed to protect against specific properties of chemicals. In general, there will be no such thing as a single type chemical protective suit on board. Therefore, contact with dangerous goods should be avoided. Chemical protective clothing is not resistant to fire or heat.

9 First aid and actions after termination of fire fighting

9.1 Any contamination with hazardous material should be immediately removed from the skin and then washed, for example with copious quantities of water. Information on medical first aid is provided in the IMO/WHO/ILO Medical First Aid Guide for Use in Accidents Involving Dangerous Goods (MFAG) published by IMO. Be prepared to use the MFAG!

9.2 Cargo may re-ignite after a fire has been extinguished. An efficient patrol should be maintained in the spaces in which the fire occurred and in any adjoining spaces to ensure that any new ignition or leakages are dealt with promptly. Fire-extinguishing systems should remain on standby. Post a fire watch.

9.3 After extinguishing the fire, all emergency team personnel should ensure that all contamination of equipment and protective clothing is removed and washed immediately. Equipment should be restored and re-stowed for use.

9.4 There are reporting procedures under SOLAS and MARPOL which have to be followed (see Reporting Procedures).

10 Special notes on classes of dangerous goods

10.1 Explosives – class 1

10.1.1 In the event of a fire, everything should be done to prevent the spread of the fire to containers which contain class 1 goods. If it is not possible to prevent the spread of the fire, all personnel should immediately withdraw from the area.

10.1.2 Many explosives will burn to the point of an explosion. The master's main concern will be whether or not there is likely to be a mass explosion. Such an explosion could damage the ship. If goods of division 1.1 or division 1.5 are involved, this likelihood will exist. The time between fire reaching the explosives and the subsequent mass explosion will be of the order

of a few seconds to minutes. The master should ascertain how large a quantity of such explosives is involved. A few kilograms are unlikely to sink the ship, but above this a clear risk to the safety of the crew and the stability of the ship should be considered. Sudden or short-term events may endanger the safety of the ship.

10.1.3 Explosives of divisions 1.2, 1.3, 1.4, and 1.6 are unlikely to explode en masse. Irrespective of the division of the explosives, any fire fighting should take place from behind substantial cover. If the risk to firefighters is too high, hoses could be lashed to the rail or other suitable fixtures and left unmanned.

10.1.4 Neither exclusion of air nor the use of smothering material is likely to be effective against a fire involving explosives. The use of the largest possible quantity of water in the shortest possible time is the only means of attempting to prevent a rise in temperature that could affect the chemical stability of the explosives.

10.1.5 Some dangerous goods of this class have been wetted or immersed in water. As they dry, they become unstable. The master should seek advice (see section 4 above).

10.2 Gases – class 2

10.2.1 Gases are substances usually transported in cylinders, flasks, portable tanks, aerosol dispensers and bottles under varying degrees of pressure. The gases may be flammable, toxic or corrosive and may be compressed, liquefied or refrigerated.

10.2.2 Gases will not start burning at the valve, unless there has been an ignition source nearby (e.g. fire or heat). The location of the burning gas needs to be identified because it may be the heart of the fire. The heating of the receptacle is the most serious danger because of the possibility of rupture, rocketing or explosion. In the event of a fire, receptacles containing gas should be liberally sprayed with water to keep them as cool as possible.

10.2.3 Non-burning leakages from receptacles of flammable gases may give rise to explosive mixtures in air. If a fire caused by the ignition of leaking gas is extinguished within a cargo space before the leak is stopped, accumulation of gas will occur. This will result in an explosive mixture or a toxic or suffocating atmosphere. The EmS SPILLAGE SCHEDULES should be consulted.

10.2.4 Extremely low temperatures around leakages of some liquefied gases are an additional hazard (other than flammability and toxicity). Emergency teams should avoid contact with such leakages and the immediate vicinity.

10.3 Flammable liquids – class 3

10.3.1 It is dangerous to direct a jet of water onto a fire involving flammable liquids. Many flammable liquids float on water and the water jet would spread the liquid, thus creating a greater danger. Closed containers exposed to fire will become pressurized and a rupture will occur.

10.3.2 Heated flammable liquid will release vapours that may start burning instantly with explosive effect. Consequently, fire-fighting personnel should stay in a well-protected position and use water spray on the area of the fire. This will cool down the temperature of the liquid and the air-vapour mixture.

10.4 Flammable solids – class 4.1

10.4.1 This class of substances includes flammable solids, water-wetted explosives (i.e. desensitized explosives) and self-reactive substances.

10.4.2 Flammable solids will easily ignite, and the appropriate EmS FIRE SCHEDULE should be consulted. In the event of a fire, water-wetted explosives (i.e. desensitized explosives) will effectively have the properties of a class 1 product. The special notes on class 1 explosives (see 10.1) and the relevant EmS FIRE SCHEDULES should be consulted.

10.4.3 Self-reactive substances are sometimes transported under temperature controlled conditions where the control temperature will depend upon the specific properties of the substance being transported. If the control temperature is exceeded, the refrigeration unit has to be inspected. If the temperature control cannot be restored, the manufacturer should be consulted as soon as possible. The manufacturer should be similarly consulted if smoke is observed. The cargo should then be kept under surveillance.

10.5 Spontaneously combustible substances – class 4.2

10.5.1 This class of substances includes pyrophoric substances, which will instantly burn on contact with air, and self-heating substances, which lead to spontaneous combustion.

10.5.2 Although the use of dry inert powdered material to smother the fire would be the preferred option, in most circumstances such a procedure may not be possible. Two methods of dealing with such fires are possible:

- .1 controlled burning: stay in a well-protected position. Let the goods burn. Many goods of this class react dangerously with water: refer to the relevant EmS FIRE SCHEDULE. In such cases, contact with water may intensify burning. Therefore, it is not recommended to apply water directly on the burning goods. When portable water monitors providing water shield function are available: generate a water screen to prevent spread of fire. The fire involving the goods should be left to burn out completely. If the fire has already spread to the adjacent cargo which is not reacting with water (see relevant EmS FIRE SCHEDULE): fight this fire from a safe distance;
- .2 fight the fire from a safe distance: if the location of the fire makes it possible, copious quantities of water should be used immediately. Although the goods on fire will react with water and create heat, a large quantity of water will cool down the reaction and prevent further heat radiation. However, water should not be used when the location of the fire makes it impossible to apply copious amounts of water directly onto the goods. Refer to the relevant EmS FIRE SCHEDULE.

10.6 Substances dangerous when wet – class 4.3

10.6.1 This class of substances reacts violently with water, evolving flammable gases. The heat of the reaction is sometimes sufficient to initiate a fire.

10.6.2 Although the use of dry inert powdered material to smother the fire would be the preferred option, in most circumstances such a procedure may not be possible. Two methods of dealing with such fires are possible:

- .1 controlled burning: stay in a well-protected position. Let the goods burn. All goods of this class react dangerously with water: refer to the relevant EmS FIRE SCHEDULE. Contact with water will intensify burning. Therefore, it is not recommended to apply water directly on the burning goods. When portable water monitors providing water shield function are available: generate water screen to prevent spread of fire. The fire involving the goods should be left to burn out completely. If the fire has already spread to adjacent cargo which is not reacting with water (see relevant EmS FIRE SCHEDULE): fight this fire from a safe distance;
- .2 fight the fire from a safe distance: refer to the relevant EmS FIRE SCHEDULE, since it is possible that fire fighting with water may intensify the fire and generate the evolution of flammable gases which could explode in mixtures with air.

10.7 Oxidizing substances – class 5.1

10.7.1 This class of substances is liable to evolve oxygen and therefore to accelerate a fire. These substances, while in themselves not necessarily combustible, may cause the combustion of other material (e.g. sawdust or paper) or contribute to the fire, leading to an explosion.

10.7.2 Fires in which these substances are present are difficult to extinguish, because the ship's fire fighting installation may not be effective. Everything possible should be done to prevent the spread of fire to containers containing these dangerous goods. However, if fire reaches the cargo, personnel should be withdrawn immediately to a well-protected position.

10.8 Organic peroxides – class 5.2

10.8.1 This class of substances is liable to burn vigorously. Some substances have a low decomposition temperature and are transported under temperature controlled conditions, where the control temperature will depend upon the specific properties of the substance being transported.

10.8.2 If the temperature control cannot be restored, the manufacturer should be consulted as soon as possible even if evolution of smoke has ceased. The cargo should then be kept under surveillance. The surrounding area should be kept isolated because liquid may be ejected from relief arrangements.

10.9 Toxic substances – class 6.1

Substances of this class are poisonous by contact or inhalation, and the use of self-contained breathing apparatus and firefighters' outfits is therefore essential.

10.10 Infectious substances – class 6.2

These are substances which are known or reasonably expected to contain pathogens, (i.e. micro-organisms that are known or reasonably expected to cause infectious disease in humans or animals). Pathogens may survive the fire and self-contained breathing apparatus should therefore be used.

10.11 Radioactive material – class 7

10.11.1 Many radioactive materials are transported in packages designed to retain their containment and shielding in accidents. However, under extreme fire conditions, failure of containment or loss of shielding or criticality safety could result in significant hazard to personnel. Long-term exposure of any class 7 package to extreme heat should be avoided and in emergencies they should be kept as cool as possible using copious quantities of water. If a packaging of radioactive material has been exposed to any significant fire, expert advice should be sought. Suspected contamination of safety and fire-fighting equipment should be removed as quickly as possible.

10.11.2 Some packages may have a class 7 label and other hazard labels. Such additional hazards may be greater than the radiation hazard. In that case, actions as specified in the applicable EmS FIRE SCHEDULE should be followed.

10.11.3 Although radiation monitors are not required by regulation on board ships, applicable relevant provisions on segregation, separation or radiation protection programmes (e.g. paragraphs 1.5.2 and 7.1.4.5.18 of the IMDG Code) or the INF Code may require monitors on board. For ships carrying radiation monitoring equipment, monitoring of radiation levels is recommended.

10.12 Corrosive substances – class 8

10.12.1 These substances are extremely dangerous to humans, and many may cause destruction of safety equipment. Burning cargo of this class will produce highly corrosive vapours. Consequently, wearing self-contained breathing apparatus is essential.

10.13 Miscellaneous dangerous substances and articles – class 9

10.13.1 This class includes those substances, materials and articles which are deemed to possess some danger, but which are not classified within the criteria of classes 1 to 8. No general guidelines are applicable to these goods. They have been allocated to the relevant EmS FIRE SCHEDULE according to their hazards in the event of a fire.

10.14 Marine pollutants

10.14.1 A number of substances within all of the above classes have also been designated as marine pollutants. Packages containing these substances will bear a Marine Pollutant mark.

10.14.2 In the case of leakage resulting from burning cargo, it is important to be aware that any spillage of a marine pollutant which is washed overboard will pollute the sea. It is, however, more important to fight a fire on board a ship rather than to prevent pollution of the sea.

General guidelines for FIRE

- Think safety first!
- Avoid any contact with dangerous substances.
- Keep away from fire, smoke, fumes and vapours.
- Sound the fire alarm and start fire-fighting procedures.
- Keep the bridge and living quarters upwind if possible.
- Locate stowage position of cargo that is burning or evolving smoke.
- Identify cargo.
- Obtain UN numbers and the EmS FIRE SCHEDULE of the dangerous goods involved.
- Consider which measures of the EmS FIRE SCHEDULE are applicable and should be followed.
- Check if other dangerous goods may potentially be involved in the fire and identify the relevant EmS FIRE SCHEDULE.
- Wear suitable protective clothing and self-contained breathing apparatus.
- Be prepared to use the Medical First Aid Guide (MFAG).
- Contact the designated person of the company responsible for the operation of the ship or a rescue coordination centre to obtain expert advice on dangerous goods emergency response measures.

Precaution: Contamination of the skin with dangerous goods should be removed and washed immediately.

Emergency Schedules for FIRE

	<i>Page</i>
F-A	17
F-B	18
F-C	19
F-D	20
F-E	21
F-F	22
F-G	24
F-H	25
F-I	26
F-J	27

FIRE SCHEDULE Alfa

F-A

GENERAL FIRE SCHEDULE

General comments		In a fire, exposed cargoes may explode or their containment may rupture. Fight fire from a protected position from as far away as possible.
Cargo on fire on deck	Packages	Create water spray from as many hoses as possible.
	Cargo Transport Units	
Cargo on fire under deck		Stop ventilation and close hatches. Use cargo space fixed fire-extinguishing system. If this is not available, create water spray using copious quantities of water.
Cargo exposed to fire		If practicable, remove or jettison packages which are likely to be involved in fire. Otherwise, keep cool using water.
Special cases: UN 1381, UN 2447		After extinguishing the fire, treat immediately as for spillage (see relevant EmS SPILLAGE SCHEDULE).

FIRE SCHEDULE Bravo

F-B

EXPLOSIVE SUBSTANCES AND ARTICLES

General comments		<p>In a fire, exposed cargoes may explode or their containment may rupture.</p> <p>Fight fire from a protected position from as far away as possible.</p> <p>All crew members should be made aware of the explosion hazard and instructed to take appropriate action.</p> <p>SUDDEN OR SHORT-TERM EVENTS (E.G. EXPLOSIONS) MAY ENDANGER THE SAFETY OF THE SHIP.</p>
Cargo on fire on deck	Packages	Use copious quantities of water from as many hoses as possible.
	Cargo Transport Units	Cargo will explode or burn fiercely. Extinguishing may not be possible.
Cargo on fire under deck		<p>Cargo will explode or burn fiercely. Extinguishing will not be possible.</p> <p>Stop ventilation and close hatches.</p> <p>Use cargo space fixed fire-extinguishing system. If this is not available, create water spray using copious quantities of water.</p>
Cargo exposed to fire		<p>Do not move packages that have been exposed to heat.</p> <p>If practicable, remove or jettison packages which are likely to be involved in the fire.</p> <p>If the packages are not directly involved in the fire, efforts should be concentrated on preventing the fire from reaching the cargo. This is done by keeping the packages wet by using water jets from as far away as practicable to drive the fire away. If the fire reaches the cargo, the firefighters should withdraw to a safe area and continue to fight the fire.</p> <p>Where practicable, articles having been exposed to the fire should be kept separated from unexposed articles. They should be kept wet and monitored from a safe distance.</p>
Special cases:		<p>Ammunition producing tear or toxic gas. The crew should be aware of the hazard. After explosion, only self-contained breathing apparatus will protect efficiently. Consult SPILLAGE SCHEDULE S-Z.</p>
UN 0018, UN 0019, UN 0020, UN 0021, UN 0301		
UN 0248, UN 0249		These water-activated devices will become more liable to explosion on contact with water.
UN 3268		SAFETY DEVICES, electrically initiated, could be subject to self-sustaining decomposition if heated. The temperature could reach 500°C, producing gas. This process may lead to an explosion of the cargo even after the exposure to heat has ended.

FIRE SCHEDULE Charlie

F-C

NON-FLAMMABLE GASES

General comments		<p>Gases in closed tanks exposed to heat may explode suddenly in or after a fire situation by a <i>boiling liquid – expanding vapour explosion</i> (BLEVE). Heated or ruptured cylinders may rocket.</p> <p>Gases listed under this schedule are non-flammable. However, some gases will support combustion though not flammable itself.</p> <p>Fire may produce leakages. Most gases allocated to this schedule are hazardous to health. Some are corrosive. Create water spray.</p> <p>Identify the source of the fire and take appropriate action.</p>
Cargo on fire on deck	Packages	Use copious quantities of water from as many hoses as possible.
	Cargo Transport Units	
Cargo on fire under deck		Use fixed fire-extinguishing system.
Cargo exposed to fire		<p>If practicable, remove or jettison packages which are likely to be involved in the fire. Otherwise, cool for several hours using water.</p> <p>Heated or ruptured cylinders may rocket.</p>
Special cases: UN 1003, UN 1070, UN 1072, UN 1073, UN 2201, UN 3156, UN 3157, UN 3513, UN 3515, UN 3518		Although these cargoes are non-flammable, they will intensify the fire.

FIRE SCHEDULE Delta

F-D

FLAMMABLE GASES

General comments		<p>Gases in closed tanks exposed to heat may explode suddenly in or after a fire situation by a <i>boiling liquid – expanding vapour explosion</i> (BLEVE).</p> <p>Crew members should be aware of the explosion hazard and take appropriate action. Keep tanks cool with copious quantities of water.</p> <p>Fight fire from a protected position from as far away as possible.</p> <p>Extinguishing a burning gas leak may lead to the formation of an explosive atmosphere. Flames may be invisible.</p>
Cargo on fire on deck	Packages	<p>Create water spray from as many hoses as possible.</p> <p>Do not try to extinguish a gas flame.</p>
	Cargo Transport Units	<p>Cool burning transport units and nearby cargo exposed to the fire with copious quantities of water.</p> <p>Do not try to extinguish a gas flame.</p>
Cargo on fire under deck		<p>Stop ventilation and close hatches.</p> <p>Use cargo space fixed fire-extinguishing system. If this is not available, create water spray using copious quantities of water.</p>
Cargo exposed to fire		<p>If practicable, remove or jettison packages which are likely to be involved in the fire. Otherwise, keep cool for several hours using water.</p>
<p>Special cases:</p> <p>UN 1038, UN 1075, UN 1965, UN 1966, UN 1972, UN 3138, UN 3160, UN 3309, UN 3312</p> <p>UN 1001, UN 3374</p> <p>UN 3501, UN 3504, UN 3505</p>		<p>SUDDEN OR SHORT-TERM EVENTS (E.G. EXPLOSIONS) MAY ENDANGER THE SAFETY OF THE SHIP.</p> <p><i>Acetylene</i> is a gas which is particularly dangerous due to its potential to explode. Rough handling or local heating may lead to delayed explosion. Keep cool for several hours using water. Do not move receptacles. All cylinders that have been subjected to rough handling or to local heating should be jettisoned.</p> <p>A flammable liquid, paste or powder may be expelled if the package is ruptured. Also consult FIRE SCHEDULE F-E.</p>

FIRE SCHEDULE Echo

F-E

NON-WATER-REACTIVE FLAMMABLE LIQUIDS

General comments		<p>Cargoes in tanks exposed to heat may explode suddenly in or after a fire situation by a <i>boiling liquid – expanding vapour explosion</i> (BLEVE). Keep tanks cool with copious quantities of water.</p> <p>Fight fire from a protected position from as far away as possible.</p> <p>Stop leakage or close open valve if practicable.</p> <p>Flames may be invisible.</p>
Cargo on fire on deck	Packages	Create water spray from as many hoses as possible.
	Cargo Transport Units	Cool burning transport units and nearby cargo exposed to the fire with copious quantities of water.
Cargo on fire under deck		<p>Stop ventilation and close hatches.</p> <p>Use cargo space fixed fire-extinguishing system. If this is not available, create water spray using copious quantities of water.</p>
Cargo exposed to fire		If practicable, remove or jettison packages which are likely to be involved in the fire. Otherwise, keep cool for several hours using water.
Special cases: UN 1162, UN 1250, UN 1298, UN 1717, UN 2985		Cargoes will create hydrochloric acid in contact with water: stay away from effluent.

FIRE SCHEDULE Foxtrot

Part 1 of 2

F–F

TEMPERATURE-CONTROLLED SELF-REACTIVES AND ORGANIC PEROXIDES

General comments		<p>Exposed cargoes may decompose violently.</p> <p>Crew members should be aware of the explosion hazard and take appropriate action.</p> <p>Fight fire from a protected position from as far away as possible.</p> <p>Switch off electrical power supplies only during fire fighting.</p> <p>Check temperature readings if possible. Measures have to be taken to alert the crew when the temperature of the cargo increases.</p> <p>In case of a temperature increase or smoke evolution, follow the relevant instructions.</p> <p>Contact the manufacturer (consignor) of the cargo as soon as possible.</p>
Cargo on fire on deck	Packages	Not applicable.
	Cargo Transport Units	<p>Cool burning transport units and nearby cargo exposed to the fire with copious quantities of water.</p> <p>After the fire has been extinguished, do not open the unit until well after smoke evolution has ceased. If possible, restore cooling. Keep under surveillance.</p>
Cargo on fire under deck		Not applicable. According to the IMDG Code, under deck stowage is not allowed. Radio for expert ADVICE.
Cargo exposed to fire	Cargo Transport Units with IBCs, Packages	<p>Cool units exposed to fire with water.</p> <p>After the fire has been extinguished, check and restore cooling. Keep under surveillance. Check temperature frequently.</p> <p>In case of temperature increase or smoke evolution, follow the relevant instructions.</p>
	Tanks	<p>Keep personnel away from tanks as liquid may be ejected from relief arrangements.</p> <p>Cool units exposed to fire with copious quantities of water.</p> <p>After the fire has been extinguished, check and restore cooling. Keep under surveillance.</p> <p>After the fire has been extinguished, water spray should be continued to cool down the outer parts of the tanks. Check refrigeration unit, keep tanks under surveillance. Check temperature frequently.</p>
Temperature increase	Cargo Transport Units with IBCs, Packages	<p>If the <i>control temperature</i> is exceeded, the refrigeration unit has to be inspected (consult manual) and repaired. If not possible and/or temperature control cannot be restored, contact the manufacturer of the cargo.</p> <p>If the <i>emergency temperature</i> is reached but the refrigeration unit is operating correctly, contact the manufacturer of the cargo and consider disposal of packagings. Keep fire-fighting team on standby.</p> <p>If the <i>emergency temperature</i> is reached due to cooling unit failure, contact the manufacturer of the cargo. When emergency temperature is reached, 12 hours are left for repairing the cooling unit and/or disposal of packaging. After that time, keep a safe distance and prepare for fire fighting.</p>
	Tanks	<p>If the <i>control temperature</i> is exceeded, the refrigeration unit has to be inspected (consult manual) and repaired. If not possible and/or temperature control cannot be restored, contact manufacturer of the cargo.</p> <p>If the <i>emergency temperature</i> is reached but the refrigeration unit is operating correctly, contact the manufacturer of the cargo. Keep at a safe distance and consider emptying of tank overboard via bottom outlet using a flexible hose.</p> <p>If the <i>emergency temperature</i> is reached due to failure of the cooling unit, repairs may be undertaken as long as the temperature has not exceeded the emergency temperature by more than 5°C. After that, consider emptying the tank using a flexible hose attached to the bottom opening of the tank if provided.</p>
Special cases: None.		

FIRE SCHEDULE Foxtrot (continued)

Part 2 of 2

F-F

TEMPERATURE-CONTROLLED SELF-REACTIVES AND ORGANIC PEROXIDES

Smoke evolution	Cargo Transport Units with IBCs, Packages	<p>Keep fire-fighting team on standby.</p> <p>The freight container should not be approached. When smoke evolution increases, keep safe distance and prepare for fire fighting. After smoke has ceased, check refrigeration system. Follow guidelines for temperature increase.</p> <p>Keep under surveillance, as new smoke evolution might take place.</p>
	Tanks	<p>Keep personnel away from the tank, as liquid may be ejected from relief arrangements. Cool unit exposed to fire with water. Use water spray from a protected position.</p> <p>In case smoke or pressure-relief venting is moderate and temperature is below the emergency temperature, consider emptying the tank overboard via bottom outlet, using a flexible hose.</p> <p>Even when smoke evolution or pressure-relief venting has ceased, water spray should be continued for some hours and the tank should be kept under surveillance, as new smoke evolution might take place.</p>
Special cases: None.		

FIRE SCHEDULE Golf

F–G

WATER-REACTIVE SUBSTANCES

General comments		<p>In a fire, exposed cargoes may explode or their containment may rupture.</p> <p>Liquid material leaking from ruptured receptacles may be ignited and spread the fire. Cargoes in tanks exposed to heat may explode suddenly in or after a fire situation by a <i>boiling liquid – expanding vapour explosion</i> (BLEVE).</p> <p>Fight fire from a protected position from as far away as possible.</p> <p>Use of copious quantities of water at once is recommended to cool down the heat radiation and to cool down heated cargo nearby.</p> <p>Water in direct contact with the material will start or intensify burning of that material. Only in locations where direct access to the cargo is possible and where the cargo on fire can be submerged with water, large quantities of water may significantly reduce the thermal reactivity and stop the fire.</p> <p>THE DANGER OF UNCONTROLLED SPREAD OF FIRE SHOULD BE CONSIDERED.</p>
Cargo on fire on deck	Packages	<p>DO NOT use water or foam; smother with dry inert powdered material when available or let fire burn.</p> <p>Cool nearby cargo with copious quantities of water.</p>
	Cargo Transport Units	<p>Let the fire burn. Cool nearby cargo with copious quantities of water. Use the water shield function of portable water monitors when available, to prevent the spread of fire.</p> <p>Try to avoid getting water into the cargo transport unit on fire.</p>
Cargo on fire under deck		<p>Stop ventilation and close hatches.</p> <p>The fixed gas fire-extinguishing system should be used. If this is not available: DO NOT use water onto the material in enclosed spaces under deck. Cool nearby cargo with copious quantities of water.</p>
Cargo exposed to fire		<p>If practicable, remove or jettison packages which are likely to be involved in the fire. Otherwise cool the cargo with copious quantities of water. Use the water shield function of portable water monitors when available, to prevent the spread of fire.</p>
Special cases: Class 4.3, packing group I		<p>In contact with water, large volumes of flammable gases are produced, which when not instantly ignited may form a highly dangerous explosive atmosphere.</p>

FIRE SCHEDULE Hotel

F–H

OXIDIZING SUBSTANCES WITH EXPLOSIVE POTENTIAL

General comments		<p>In a fire, exposed cargoes may explode or their containment may rupture. Crew members should be aware of the explosion hazard and take appropriate action. Fight fire from a protected position from as far away as possible. SUDDEN OR SHORT-TERM EVENTS (E.G. EXPLOSIONS) MAY ENDANGER THE SAFETY OF THE SHIP.</p>
Cargo on fire on deck	Packages	Create water spray from as many hoses as possible.
	Cargo Transport Units	
Cargo on fire under deck		<p>OPEN HATCHES to provide maximum ventilation. Fixed gas fire-extinguishing systems may not be effective on these fires. Create water spray from as many hoses as possible.</p>
Cargo exposed to fire		<p>Do not move packages that have been exposed to heat. If practicable, remove or jettison packages which are likely to be involved in the fire. If the packages are not directly involved in the fire, efforts should be concentrated on preventing the fire from reaching the cargo. This is done by keeping the packages wet by using water jets from as far away as practicable to drive the fire away. If the fire reaches the cargo, the firefighters should withdraw to a safe area and continue to fight the fire from a safe position. Where practicable, articles having been exposed to the fire should be kept separated from unexposed articles. They should be kept wet and monitored from a safe distance.</p>
Special cases: None.		

FIRE SCHEDULE India

F-I

RADIOACTIVE MATERIAL

General comments		<p>Evacuate compartment or downwind area of non-essential personnel.</p> <p>Do not touch damaged packages.</p> <p>In cases of suspected radioactive contamination, limit entry of firefighters for the shortest time possible.</p> <p>For ships carrying radiation monitoring equipment, measure radiation levels.</p> <p>Radio for expert ADVICE.</p> <p>After the fire has been extinguished, clean ship's surfaces with copious quantities of water.</p> <p>Decontaminate firefighters before protective clothing is removed. Isolate potentially contaminated clothing and equipment.</p> <p>If exposure of personnel is suspected, clean body and hair with warm water and soap; discharge resultant washings directly overboard.</p> <p>Record the names of potentially exposed persons. Ensure medical examination of these persons after reaching any medical staff.</p> <p>For ships carrying radiation monitoring equipment, continue monitoring of radiation levels after fire is extinguished.</p>
Cargo on fire on deck	Packages	Create water spray from as many hoses as possible.
	Cargo Transport Units	<p>Create water spray from as many hoses as possible.</p> <p>Cool burning transport units and nearby cargo exposed to the fire with copious quantities of water.</p>
Cargo on fire under deck		<p>Stop ventilation and close hatches.</p> <p>Use cargo space fixed fire-extinguishing system. If this is not available, create water spray using copious quantities of water.</p>
Cargo exposed to fire		If practicable, remove or jettison packages which are likely to be involved in the fire. Otherwise, cool for several hours using copious quantities of water.
<p>Special cases:</p> <p>UN 2977, UN 2978, UN 3507</p> <p>UN 3332, UN 3333</p> <p>Subsidiary label class 4.2 or class 4.3</p>		<p>Chemical hazard greatly exceeds radiation hazard. Material reacts with moisture to form toxic and corrosive gas. The run-off may be corrosive. Keep clear.</p> <p>Exposed cargoes may explode in a fire. Create water spray.</p> <p>Leak may be evident by visible and irritating vapours. Released vapours may also react violently with hydrocarbons (fuel).</p> <p>If the source capsule is identified as being out of its packaging, do not touch. Stay away, minimize exposure to radiation by limiting time near material and by maximizing distance. Radio for expert ADVICE.</p> <p>All radioactive material with subsidiary hazard label 4.2 or 4.3 affixed (e.g. pyrophoric uranium or thorium metal):</p> <p>Radio for expert ADVICE.</p> <p><i>On deck:</i> Do not use water onto the material. Cool nearby cargo with copious quantities of water, although the fire could intensify for a short period. Do not spray small quantities of water onto the fire, use copious quantities of water.</p> <p><i>Under deck:</i> Stop ventilation and close hatches.</p> <p>The fixed gas fire-extinguishing system should be used.</p> <p>If this is not available, do not use water onto the material in enclosed spaces under deck. With open hatches, cool nearby cargo with copious quantities, although the fire could intensify for a short period. Do not spray small quantities of water onto the fire, use copious quantities of water only.</p>

FIRE SCHEDULE Juliet

F–J

NON-TEMPERATURE-CONTROLLED SELF-REACTIVES AND ORGANIC PEROXIDES

General comments		Exposed cargoes may decompose violently. Crew members should be aware of the explosion hazard and take appropriate action. Fight fire from a protected position from as far away as possible. Exposed cargoes may decompose violently in a fire.
Cargo on fire on deck	Packages	Not applicable.
	Cargo Transport Units	Cool burning transport units and nearby cargo exposed to the fire with copious quantities of water. After the fire has been extinguished, carry on water spraying of the container for several hours. Do not open container until well after smoke evolution has ceased. After this, cool down packages or IBCs if practicable for at least 1 hour with water. Otherwise, check contents on regular intervals. In case smoke is evolved again, apply further water cooling. Dispose of residues overboard. Clean the area thoroughly. After the fire has been extinguished, keep cargo transport unit under surveillance.
Cargo on fire under deck		Not applicable – According to the IMDG Code, under deck stowage is not allowed. Radio for expert ADVICE.
Cargo exposed to fire	Cargo Transport Units with IBCs, Packages	Cool unit exposed to the fire with water. After the fire has been extinguished, keep transport unit under surveillance. In case of smoke evolution, follow the relevant instructions.
	Tanks	Keep personnel away from tank, as fluid ejection from relief arrangements might take place. Cool unit exposed to the fire with water. Contact the manufacturer (consignor) of the cargo. Cooling the tank should be continued until the temperature is below 50°C. Check temperature frequently. If temperature increases again, cool unit with water. Consider emptying the tank overboard via bottom outlet, using a flexible hose.
Smoke evolution	Cargo Transport Units with IBCs, Packages	Cool unit with water. Use water spray from a protected position. Do not open the unit until well after smoke evolution has ceased. After this, cool down packages or IBCs if practicable for at least 1 hour with water. Otherwise, check contents on regular intervals. In case smoke is evolved again, apply further water cooling. Dispose of residues overboard. Clean the area thoroughly.
	Tanks	Keep personnel away from the tank, as fluid ejection from relief arrangements might take place. Cool unit exposed to fire with water. Use water spray from a protected position. Even when smoke evolution or pressure-relief venting has ceased, cooling the tank should be continued until the temperature is below 50°C. Check temperature frequently. If temperature increases again, cool unit with water. Consider emptying tank overboard via bottom outlet, using a flexible hose.
Special cases: None.		

Spillage

Introduction to the Emergency Schedules for SPILLAGE

1 Be prepared

1.1 Incidents involving dangerous goods may result in spillages from such goods, and the magnitude of the effects of an incident depends upon the type and amount of product released, together with the type of any other product involved and whether the spillage is on deck or in enclosed spaces.

1.2 Spillages could create additional hazards to those indicated by classification and labelling of the dangerous goods (e.g. the spillage of a flammable liquid may create an explosive atmosphere). Of particular concern are leakages of reactive chemicals, which in contact with other materials or further spillages will produce additional or other chemicals (e.g. toxic gases).

1.3 When dealing with a spillage on board a ship, the value of crew training and of familiarity with the general contingency plan will become evident. Drills and exercises specific to the cargoes on board at the time should be a part of shipboard routine.

1.4 This Guide should be integrated into the ship's Safety Management System. Procedures contained within the shipboard emergency plan have to be tailored to the individual ship. Spillage response procedures within the EmS SPILLAGE SCHEDULES are differentiated for "on deck" and "under deck" stowage. For specific ship types (e.g. hatchless container ships) or cargo spaces (e.g. open vehicle decks of ferries) these two procedural categories have to be assigned specifically to the individual ship (e.g. run-off considerations concerning bilges and drains).

2 Personal protection

2.1 The safety of the emergency personnel is of paramount importance.

2.2 The likelihood of the development of an explosive, flammable or toxic atmosphere should be considered.

2.3 Full protective clothing resistant to the effects of the specific dangerous substance involved should be worn. The protective clothing should cover all skin so that no part of the body is unprotected. Wearing self-contained breathing apparatus is essential to protect against inhalation of toxic or corrosive dusts, vapours or gases.

2.4 Emergency teams should avoid direct contact with any dangerous goods regardless of the protective clothing being used. If direct contact takes place when dealing with a spillage, the contact time should be kept to a minimum.

2.5 It is a requirement of SOLAS that four sets of full protective clothing resistant to chemical attack should be provided in addition to firefighters' outfits.

2.6 Firefighters' outfits are not designed to protect against chemical hazards and chemical-resistant clothing is not designed to protect against fire. Masters are reminded that personnel should have regular training in the use of self-contained breathing apparatus, and that special attention should be paid to ensuring that face masks fit satisfactorily at all times.

2.7 Responders should also ensure that any chemical protective clothing is used with other suitable protection against the specific hazards involved.

3 General response

3.1 The safety of the emergency personnel is most important.

3.2 Working spaces and living quarters should be protected by water spray wherever possible. Ventilation systems for living quarters and working spaces should be shut off, closed and secured to reduce the possibility of smoke, dust, fumes and gases from entering these areas. Particular care should be given to ventilation inlets (e.g. machinery and accommodation spaces). It may be necessary to turn the ship to ensure that the accommodation spaces are upwind.

3.3 Before entering cargo holds or compartments, the emergency personnel should determine the oxygen content of the space's atmosphere and should test for the presence of dangerous vapours. If a confined space entry is attempted, the use of self-contained breathing apparatus is essential. Only trained personnel should use this equipment, which should be well maintained.

3.4 It is essential to ensure that there is always an escape route for emergency personnel despite the limited means of escape due to narrow exit paths and the danger of falling overboard.

3.5 Decontamination and medical first aid also need to be considered. Arrange for a decontamination station to be set up at a suitable safe location.

3.6 The general response to spillage involving dangerous goods can be subdivided into the following tactical objectives:

- .1 identification;
- .2 rescue;
- .3 isolation; and
- .4 response.

Experience from previous incidents has shown that these objectives can normally be achieved in this order.

4 Identification of the dangerous goods involved

4.1 It is essential to identify the dangerous good(s) involved in the spillage in order that the specific EmS SPILLAGE SCHEDULE(S) for the cargo(es) may be consulted and appropriate action taken. This is important because some dangerous goods are incompatible with some media available for dealing with a spillage.

4.2 An identification number with four digits preceded by the letters "UN" is assigned to each dangerous good. From the UN number, it is possible to find the appropriate EmS SPILLAGE SCHEDULE. The Dangerous Goods List in part 3 of chapter 3.2 of the IMDG Code contains the names and the UN numbers, as well as the EmS SCHEDULE numbers. The Dangerous Goods Manifest and the Stowage Plan required by SOLAS regulation VII/4.2 will also contain the proper shipping name and UN number of the dangerous good(s) concerned. Packages will usually be labelled as well.

4.3 Specific information as to properties of dangerous goods may also be found in the Dangerous Goods List in the IMDG Code. Dangerous goods are classified and labelled according to their hazards. Labels and marks on packages provide a warning of the general risks to be encountered. Personnel should understand the labelling system. It will also be beneficial to consult other sources of information. A safety data sheet provided by the manufacturer may be one such source of additional information. Seek expert advice from manufacturers, specialized agencies or professional responders.

4.4 Emergency preparedness should form part of the ship's Safety Management System as required by the ISM Code. Prepared information can reduce errors during a spillage emergency. Therefore, it is recommended that the EmS SCHEDULE(S) be identified and included within the Dangerous Goods Manifest and Stowage Plan, so directly connected to the stowage position of the cargo. This will enable key members of the crew to know in advance which emergency procedures would be necessary. In the event of a spillage, the allocation of a specific EmS SPILLAGE SCHEDULE via identification of the cargo via the UN number takes time and is open to error, especially in mixed cargoes in one container. Furthermore, some spillage response procedures may require specific use of material which could be hampered by an inaccessible stowage location. After locating the spillage area, the advice given in the EmS SPILLAGE SCHEDULE should be directly available from the Dangerous Goods Manifest and Stowage Plan.

5 Rescue

5.1 The safety of personnel should be the highest priority. One of the first concerns after evaluating the situation of the incident is finding and rescuing victims. This includes searching for and evacuating persons who may be exposed or who are disoriented or disabled by the release. It might be necessary to rescue persons from elevated places or confined spaces or those who are pinned under wreckage.

5.2 Appropriate equipment will need to be available, and prior training is essential for such circumstances.

6 Isolation

6.1 The objective of isolation is to limit the number of personnel exposed to the spilled material. This may be achieved by simply roping or taping off dangerous areas. Consider sealing off ventilation, air conditioning and other openings to living and working spaces.

6.2 At sea, the master has the capability and discretion to alter course and speed to ensure that dangerous gases or vapours are kept away from personnel, living quarters or ventilation inlets.

6.3 Consider the evacuation of passengers and members of the crew.

7 Response

7.1 At sea, human and other resources are limited. So in most cases involving spillage of dangerous goods, the most effective response will probably be to wash the substance overboard or jettison it. Attempts to repack dangerous goods may expose personnel to unreasonable risks.

7.2 The response to the spillage should be in accordance with the appropriate EmS SPILLAGE SCHEDULE(S) for the dangerous good(s) involved in the incident. The emergency team should take all reasonable precautions when dealing with the spillage and remember that the safety of personnel is most important.

8 Seek advice

8.1 Always seek expert ADVICE when dealing with dangerous goods spills. Such ADVICE could be given by:

- .1 ship operating companies (e.g. designated persons);
- .2 emergency information centres (such as CHEMTREC in the USA);
- .3 specialized agencies;
- .4 professional responders;
- .5 port State authorities;
- .6 coastguards;
- .7 fire brigades; and
- .8 manufacturers of the products.

9 Materials to be used

9.1 Water is the obvious medium to be used when dealing with a spillage on board a ship. It is recommended in the majority of cases to be used in copious quantities to wash the spillage overboard. However, certain dangerous goods react violently with water, producing flammable and toxic vapours. Others, for example marine pollutants, will produce pollution if washed overboard.

9.2 The term "copious quantities of water" used within the EmS SPILLAGE SCHEDULE(S) refers to the minimum total quantities of water provided for optimal fire fighting with four jets as defined by SOLAS regulation II-2/10, Construction requirements. Master and crew should consider practical limitations at specific stowage locations in this respect.

9.3 Inert material should be used for spillages where it would be dangerous to use water. The inert material should be dry.

9.4 Sawdust should not be used as it is liable to be ignited by ignition sources or in contact with a number of substances. Cement may be used as an inert material for barricading.

9.5 An electric discharge may ignite some materials (e.g. explosives). Therefore, the use of non-certified safe type equipment within spillage areas may be dangerous. For some materials, "non-sparking footwear" is recommended (e.g. rubber boots without metal parts).

10 Action after spillage has been dealt with

10.1 Decontamination of personnel, clothing and ship's structures

10.1.1 After the spillage has been dealt with, the emergency team personnel should ensure that all contamination of equipment and protective clothing is removed and washed immediately. All equipment should be restored and re-stowed for further use.

10.1.2 Areas not affected initially may have been contaminated during response procedures. Crew members coming in contact with improperly decontaminated areas may become contaminated. Clean the site thoroughly before any unprotected personnel are allowed to enter.

10.1.3 Contaminated material should be properly disposed of or be cleaned.

11 First aid

11.1 Information on medical first aid is provided in the IMO/WHO/ILO Medical First Aid Guide for Use in Accidents Involving Dangerous Goods (MFAG). Be prepared to use the MFAG!

11.2 Any contamination of the skin with a dangerous substance should be immediately removed and then washed, for example with water. Radio for expert advice if personnel have been exposed to dangerous goods.

12 Special notes on specific dangerous goods classes

12.1 Based on the specific properties of the individual dangerous goods listed under one UN number, experts have allocated the substances, articles and materials to EmS SPILLAGE SCHEDULES. The allocation has not been based on the classification and labelling of the substances only. However, to help the mariner who is used to the handling and labelling of packaged dangerous goods to understand the advice given in the EmS SPILLAGE SCHEDULES, this introduction based on classification properties of substances is given.

12.2 Explosives – class 1

12.2.1 Properly packaged explosives are unlikely to detonate unless exposed to a fire or source of ignition. Within the divisions of this class, there are differences in explosive power. From a mariner's standpoint, the volumes of explosives concerned are of primary importance for the safety of the ship. However, even small volumes of spilled material may ignite and injure individual crew members. In general, spilled explosive substances are less hazardous when kept wet (see SPILLAGE SCHEDULE S-X).

12.2.2 Some explosive mixtures are stabilized in such a way that water will separate explosives from the stabilizer, thus creating a higher risk. The explosive component becomes very sensitive to shock and heat. The explosive should be kept mixed under water and washed overboard. Wetted articles should be jettisoned (see SPILLAGE SCHEDULE S-Y).

12.2.3 Some ammunition types contain a toxic material or a tear-gas substance. In addition to the explosive hazard, the toxicity hazard has to be realized. Use of self-contained breathing apparatus is essential (see SPILLAGE SCHEDULE S-Z).

12.3 Gases – class 2

12.3.1 A release of a flammable gas (class 2.1) is the preliminary step leading to a potential vapour cloud explosion (VCE). For a blast to take place, the substance has to mix with air in a quantity that will allow the mixture to form a cloud. As soon as a friction (electrostatic potential) lies within the explosive range and encounters an ignition source, a flash fire, a deflagration or, sometimes, even a detonation may occur, with devastating consequences. In dealing with gas leakages, let the gas evaporate and drift away. Keep away all sources of ignition. Water spray could reduce the ignition potential of the cloud (see SPILLAGE SCHEDULE S-U).

12.3.2 Non-toxic, non-flammable gases (class 2.2) may displace oxygen, creating a suffocation hazard. Ventilation of all areas concerned is important (see SPILLAGE SCHEDULE S-V).

12.3.3 Toxic gases (class 2.3) when released may fill an area of the ship or a compartment with a toxic atmosphere. Therefore, it is important to shut off, close and secure all ventilation supplying the accommodation, machinery spaces and bridge to protect against such gases. Self-contained breathing apparatus is essential for the emergency team (see SPILLAGE SCHEDULE S-U).

12.3.4 Liquefied gases can cause the additional hazard of very low temperatures around the point of leakage. Such a leakage will be particularly dangerous when the leakage is in the liquid phase from a container where very low temperatures will be experienced. The emergency team should avoid contact with liquefied gases if at all possible.

12.3.5 Oxidizing gases can react violently with a number of organic materials. These reactions can generate heat, produce flammable gases and are liable to ignite combustible materials.

12.4 Flammable liquids – class 3

12.4.1 The release of a vaporized flammable liquid is the preliminary step leading to a potential vapour cloud explosion (VCE). For a blast to take place, the vapour has to mix with air in a quantity that will allow the mixture to form a cloud. As soon as a friction (electrostatic potential) lies within the explosive range and encounters an ignition source, a flash fire, a deflagration or, sometimes, even a detonation may occur, with devastating consequences. Water spray will reduce the vaporization and the ignition potential of the cloud. Keep away all sources of ignition (see SPILLAGE SCHEDULE S-D).

12.4.2 At high concentrations, many flammable liquids exhibit a narcotic effect (which is not labelled accordingly), a short-term potentially lethal effect (which is identified by a class 6.1 label) or a long-term toxic effect (not labelled). In all cases, the use of self-contained breathing apparatus is therefore recommended (see SPILLAGE SCHEDULE S-D).

12.4.3 Some flammable liquids are corrosive to human skin, the ship's hull or normal personal protection equipment. Their vapours are toxic by inhalation. Therefore, washing of spillages and forcing vapours overboard with water spray is the method of choice. It is important to close all ventilation to protect the accommodation and machinery spaces and the bridge from the vapours. Crew members should stay away from any effluent (see SPILLAGE SCHEDULE S-C).

12.4.4 Many flammable liquids are not soluble in water and will float on the water (e.g. mineral oil, gas oil, petroleum). In general, high concentrations of these substances are not lethal but exhibit a narcotic effect. The crew should be aware of that and stay away from

highly concentrated vapours. Mineral oil is considered to be a marine pollutant although not classified nor labelled as such. Depending on the quantities, oil spilt into the sea may cause problems and is usually given a high profile by the media. In case of spillage on board, the dominating hazard is flammability. Keep away all sources of ignition (see SPILLAGE SCHEDULE S-E).

12.5 Flammable solids – class 4

12.5.1 This class contains many different substances and varying hazards within its three sub-classes. Many are not solids. Some of these materials require special agents to be used for cleaning/absorbing as they react unfavourably with water, sand or other inert material. The procedures and materials to be used in case of a spillage are identified in ten different schedules.

12.5.2 Spilled flammable solids may create an explosive atmosphere that could be ignited easily. Whereas some solids (e.g. articles) can be repacked (see SPILLAGE SCHEDULE S-I), others will contaminate ships' surfaces, which have to be cleaned thoroughly by washing the substances overboard (see SPILLAGE SCHEDULE S-G).

12.5.3 A few flammable substances are transported in a molten state. To clean contaminated areas, the use of inert materials is possible to enable the emergency team to shovel up the spillage and dispose of it overboard (see SPILLAGE SCHEDULE S-H).

12.5.4 Flammable solids that exhibit explosive properties when spilt from a package should be kept wet and disposed of overboard. Drying material being ignited (e.g. by heat or friction) would lead to a detonation (see SPILLAGE SCHEDULE S-J).

12.5.5 Temperature-controlled self-reactive substances are also classified as flammable solids under class 4.1. Spillage is often connected to a failure of temperature control, leading to chemical reaction and creating a fire hazard. If not disposed of overboard, the relevant FIRE SCHEDULE should be consulted (see SPILLAGE SCHEDULE S-K).

12.5.6 Some spontaneously combustible substances could react with water (see SPILLAGE SCHEDULE S-L). Smothering with dry inert material and the immediate disposal overboard could limit the ignition hazard. Others will ignite within minutes (see SPILLAGE SCHEDULE S-M) and fire fighting will be necessary (see FIRE SCHEDULE F-G).

12.5.7 Depending on the chemical properties, substances which are dangerous when wet (class 4.3) could be collected and disposed of overboard (see SPILLAGE SCHEDULE S-P), or could be kept dry and disposed of overboard or could be washed overboard with copious quantities of water even though a reaction with water will occur (see SPILLAGE SCHEDULES S-N and S-O). The use of water spray is recommended in case of the development of flammable gases (see SPILLAGE SCHEDULE S-O).

12.5.8 Many flammable solids, substances liable to spontaneous combustion and most substances that are dangerous when wet are hazardous to health by skin contact or by inhalation of dust. The use of self-contained breathing apparatus and appropriate chemical protection (e.g. chemical suit) is therefore recommended in all cases.

12.6 Oxidizing substances and organic peroxides – class 5

12.6.1 Dangerous goods of class 5 contain oxygen, and some will ignite combustible material on contact. In general, contact with substances of class 5 will be harmful to the skin, eyes and mucous membranes. The use of self-contained breathing apparatus and appropriate chemical protection (e.g. chemical suit) is therefore recommended.

12.6.2 Spilled oxidizing substances (class 5.1) could ignite combustible material or destroy materials (e.g. personal protection) by their chemical reactivity. Such spillages should be washed overboard. All crew members should stay away from effluent (see SPILLAGE SCHEDULE S-Q).

12.6.3 Organic peroxides (class 5.2) are highly reactive and some may explode when ignited. Class 5.2 liquids are flammable liquids which should be kept away from all sources of ignition. These substances will instantly destroy eyes. Some substances are transported under temperature control which is necessary to prevent reaction (mostly noticed as smoke evolution) and development of heat which may lead to fire (see SPILLAGE SCHEDULE S-R).

12.7 Toxic and infectious substances – class 6

12.7.1 The effects of toxic substances (class 6.1) may appear at once during exposure to them or may be delayed until after exposure. Inhalation is the major route for vapours, gases, mists and dusts. Skin and eye contact is of concern for the emergency team. The use of self-contained breathing apparatus and appropriate chemical protection (e.g. chemical suit) is recommended in all cases. Vapours of toxic liquids may fill an area of the ship or a space with a toxic atmosphere. Therefore, in case of vapour development, it is important to shut off, close and seal off all ventilation leading to accommodation and machinery spaces and the bridge (See SPILLAGE SCHEDULE S-A).

12.7.2 Some toxic substances are also flammable. In this case, the safety advice for both flammable and toxic liquids should be followed (see SPILLAGE SCHEDULE S-D).

12.7.3 In case of spillage of toxic substances, be prepared to use the MFAG.

12.7.4 The substances of class 6.2 are infectious, biological products, diagnostic specimens, clinical waste, etc. In case of spillage of such substances, different types of a biohazard may develop. Some spilled goods of class 6.2 could create illness of crew members after skin contact or inhalation. Whereas washing overboard is advised for on-deck spillage, waiting for expert ADVICE is recommended for under-deck spillages. Any skin contact or inhalation of mists or dusts should be avoided. Expert ADVICE is particularly important in respect of exposure risk, decontamination methods and reporting procedures (see SPILLAGE SCHEDULE S-T).

12.7.5 Most toxic substances and many infectious substances are also toxic to marine animals. Consult safety data sheets or experts for individual properties if needed.

12.8 Radioactive material – class 7

12.8.1 Many radioactive materials are transported in packages designed to retain their containment and shielding under accident conditions. Failure of the containment resulting in spillage that could be a significant hazard to personnel would only be expected under very severe conditions. Damp surfaces on undamaged or slightly damaged packages are seldom an indication of packaging failure. If a packaging of radioactive material appears to have leaked its accidental contents, expert ADVICE should be sought.

12.8.2 Some packages may have both a class 7 label and other hazard labels. Such additional hazards may be greater than the radiation hazard. In that case, actions as specified in the applicable SPILLAGE SCHEDULES should be followed.

12.8.3 Although radiation monitors are not required by regulation on board ships, applicable relevant provisions on segregation, separation or radiation protection programme (e.g. paragraphs 1.5.2 and 7.1.4.5.18 of the IMDG Code) or the INF Code may require monitors on board. For ships carrying radiation monitoring equipment, monitoring the extent of contamination is possible.

12.8.4 Spillage may constitute a release of any solid, liquid or gaseous radioactive material from its packaging. Personal protection material and equipment on board cannot generally provide protection against the health effects of penetrating ionizing radiation. Therefore, to protect personnel from the potential effects of radiation from spilled cargo (which may include the release from the packaging of special form radioactive material), two parameters are important when responding to spillages of these materials: TIME and DISTANCE. Entry of personnel into the area involving the spill of radioactive material should be limited to the shortest time possible, and the distance between the spillage and any personnel should be maximized. In addition, radiation contamination of personnel by inhalation, ingestion or skin contact should be of concern, and appropriate protective actions should be taken (protective clothing and self-contained breathing apparatus is recommended in all cases) (see SPILLAGE SCHEDULE S-S).

12.9 Corrosive substances – class 8

12.9.1 Corrosive solids and liquids can permanently damage human tissue. Some substances may corrode steel and destroy other materials (e.g. personal protection equipment). Corrosive vapours are highly toxic, often lethal by destroying lung tissue. All corrosive chemicals will be dangerous to human health (toxic). Avoid direct contact with the skin, protect against inhalation of vapours or mists. The use of self-contained breathing apparatus and appropriate chemical protection (e.g. chemical suit) is recommended in all cases. Washing spillages and forcing vapours overboard with water spray is the method in all cases. It is important to shut off, close and secure all ventilation leading into the accommodation of choice, machinery spaces and the bridge. All personnel should stay away from effluent (see SPILLAGE SCHEDULE S-B).

12.9.2 Some corrosive substances are also flammable. In these cases, the safety advice for both flammable and corrosive substances should be followed. Use of copious quantities of water and water spray is recommended. In general, the flammability hazard is more important than the corrosive properties for the safety of the ship and the crew (see e.g. SPILLAGE SCHEDULES S-C and S-G).

12.10 Miscellaneous dangerous substances and articles – class 9

12.10.1 This class contains miscellaneous dangerous substances that do not fit easily under the criteria for other hazard classes. Nonetheless, these substances represent hazards. There are no common properties that apply to all goods of this class. They have been allocated to the relevant EmS SPILLAGE SCHEDULE according to their hazards in the event of a spillage.

12.11 Marine pollutants

12.11.1 A number of substances within all classes have also been designated as marine pollutants because they are hazardous to marine life. Packages containing these substances will bear a Marine Pollutant mark.

12.11.2 In the case of spillage, it is important to be aware that any marine pollutant which is washed overboard will pollute the sea and must therefore be reported in accordance with the Reporting Procedures by the fastest telecommunication channel available with the highest possible priority to the nearest coastal State (see Reporting Procedures).

12.11.3 It is, however, more important to ensure the safety of the crew and the integrity of the laden ship, rather than to prevent pollution of the sea by marine pollutants.

General guidelines for SPILLAGE

- Think of safety first!
- Avoid any contact with dangerous substances. Do not walk through spilled liquids or dust (solids).
- Keep away from vapours or gases.
- Sound alarm.
- Keep the bridge and living quarters upwind if possible.
- Wear full protective clothing resistant to chemical attack and self-contained breathing apparatus.
- Locate stowage position of leaking cargo.
- Identify cargo.
- Obtain UN numbers and the EmS SPILLAGE SCHEDULE of dangerous goods involved.
- Consider which measures of the EmS SPILLAGE SCHEDULE are applicable and should be followed.
- Be prepared to use the Medical First Aid Guide (MFAG).
- Contact the designated person of the company responsible for the operation of the ship to obtain expert advice on dangerous goods emergency response measures.

Precaution: Contamination of the skin with any dangerous goods should be removed and washed immediately.

Emergency Schedules for SPILLAGE

	Page
S-A.....	40
S-B.....	41
S-C.....	42
S-D.....	43
S-E.....	44
S-F.....	45
S-G.....	46
S-H.....	47
S-I.....	48
S-J.....	49
S-K.....	50
S-L.....	51
S-M.....	52
S-N.....	53
S-O.....	54
S-P.....	55
S-Q.....	56
S-R.....	57
S-S.....	58
S-T.....	60
S-U.....	61
S-V.....	63
S-W.....	64
S-X.....	65
S-Y.....	66
S-Z.....	67

SPILLAGE SCHEDULE Alfa

S-A

TOXIC SUBSTANCES

General comments		<p>Wear suitable protective clothing and self-contained breathing apparatus.</p> <p>Avoid contact, even when wearing protective clothing.</p> <p>Stop leak if practicable.</p> <p>Contaminated clothing should be washed off with water and then removed.</p>
Spillage on deck	Packages (small spillage)	Wash overboard with copious quantities of water. Do not direct water jet straight onto the spillage. Keep clear of effluent. Clean the area thoroughly.
	Cargo Transport Units (large spillage)	<p>Keep bridge and living quarters upwind.</p> <p>Wash overboard with copious quantities of water. Do not direct water jet straight onto the spillage. Keep clear of effluent. Clean the area thoroughly.</p>
Spillage under deck	Packages (small spillage)	<p>Do not enter space without self-contained breathing apparatus. Check atmosphere before entering (toxicity and explosion hazard). If atmosphere cannot be checked, do not enter. Let vapours evaporate. Keep clear.</p> <p><i>Liquids:</i> Provide good ventilation of the space. Restrict flow of liquid to an enclosed area (e.g. by barricading with inert material or cement if available).</p> <p><i>Solids:</i> Collect spillage. Dispose of overboard.</p> <p>Otherwise, keep clear. Radio for expert ADVICE.</p>
	Cargo Transport Units (large spillage)	<p>Keep clear. Radio for expert ADVICE. After hazard evaluation by experts, you may proceed.</p> <p>Provide adequate ventilation. Do not enter space without self-contained breathing apparatus.</p> <p>Check atmosphere before entering (toxicity and explosion hazard). If atmosphere cannot be checked, do not enter. Let vapour evaporate, keep clear. Where the ventilation system is used, particular attention should be taken to prevent toxic vapours or fumes entering occupied areas of the ship, e.g. living quarters, machinery spaces, working areas.</p> <p><i>Liquids:</i> Provide good ventilation of the space. Wash down to the bottom of the hold. Pump overboard.</p> <p><i>Solids:</i> Collect spillage. Keep spilt solids dry and cover with plastic sheet. Dispose of overboard. Otherwise, close hatches. Wait until the ship arrives in port.</p>
Special cases: Marine Pollutant Mark		<p>Keep disposal overboard as low as possible. Dilute with copious quantities of water. Report incident according to MARPOL reporting requirements.</p>
UN 3546		<p>Substances might be spilled when the articles are damaged.</p> <p>Undamaged articles can be collected</p>

SPILLAGE SCHEDULE Bravo

S-B

CORROSIVE SUBSTANCES

General comments		<p>Wear suitable protective clothing and self-contained breathing apparatus.</p> <p>Avoid contact, even when wearing protective clothing.</p> <p>Keep clear of effluent. Keep clear of evolving vapours.</p> <p>Even short-time inhalation of small quantities of vapour can cause breathing difficulties.</p> <p>Use of water on the substance may cause a violent reaction and produce toxic vapours.</p> <p>Substance may damage ship's construction materials.</p> <p>Contaminated clothing should be washed off with water and then removed.</p>
Spillage on deck	Packages (small spillage)	Wash overboard with copious quantities of water. Do not direct water jet straight onto the spillage. Keep clear of effluent. Clean the area thoroughly.
	Cargo Transport Units (large spillage)	<p>Keep bridge and living quarters upwind. Protect crew and living quarters against corrosive or toxic vapours by using water spray to drive vapours away.</p> <p>Wash overboard with copious quantities of water. Do not direct water jet straight onto the spillage. Keep clear of effluent. Clean the area thoroughly.</p>
Spillage under deck	Packages (small spillage)	<p>Provide adequate ventilation. Do not enter space without self-contained breathing apparatus. Check atmosphere before entering (toxicity and explosion hazard). If atmosphere cannot be checked, do not enter. Let vapour evaporate. Keep clear.</p> <p><i>Liquids:</i> Provide good ventilation of the space. Wash down to the bottom of the hold. Use copious quantities of water. Pump overboard.</p> <p><i>Solids:</i> Collect spillage. Dispose of overboard. Wash residues down to the bottom of the hold. Use copious quantities of water. Pump overboard.</p>
	Cargo Transport Units (large spillage)	<p>Keep bridge and living quarters upwind. Protect crew and living quarters against corrosive or toxic vapours by using water spray to drive vapours away.</p> <p>Do not enter space. Keep clear. Radio for expert ADVICE. After hazard evaluation by experts, you may proceed.</p> <p>Provide adequate ventilation. Do not enter space without self-contained breathing apparatus. Check atmosphere before entering (toxicity and explosion hazard). If atmosphere cannot be checked, do not enter. Let vapours evaporate, keep clear. Where a ventilation system is used, particular attention should be taken in order to prevent toxic vapours or fumes entering occupied areas of the ship, e.g. living quarters, machinery spaces, working areas.</p> <p><i>Liquids:</i> Provide good ventilation of the space. Wash down to the bottom of the hold. Use copious quantities of water. Pump overboard.</p> <p><i>Solids:</i> Collect spillage. Dispose of overboard. Wash residues down to the bottom of the hold. Use copious quantities of water. Pump overboard.</p>
Special cases: Marine Pollutant Mark UN 2802, UN 2809, UN 3506 UN 3547		<p>Report incident according to MARPOL reporting requirements.</p> <p>No reaction with water. Not highly corrosive to protective clothing. Collect spillages if practicable. Try to avoid disposal overboard. Radio for expert ADVICE.</p> <p>Substances might be spilled when the articles are damaged. Undamaged articles can be collected.</p>

SPILLAGE SCHEDULE Charlie

S-C

FLAMMABLE, CORROSIVE LIQUIDS

General comments		<p>Wear suitable protective clothing and self-contained breathing apparatus.</p> <p>Avoid contact, even when wearing protective clothing.</p> <p>Keep clear of effluent. Keep clear of evolving vapours.</p> <p>Even short-time inhalation of small quantities of vapour can cause breathing difficulties.</p> <p>Use of water on the substance may cause violent reaction and produce toxic vapours.</p> <p>Substance may damage the ship's construction materials.</p> <p>Spillage or reaction with water may evolve flammable vapours. Avoid all sources of ignition (e.g. naked lights, unprotected light bulbs, electric hand tools, friction).</p> <p>Contaminated clothing must be washed off with water and then removed.</p>
Spillage on deck	Packages (small spillage)	Wash overboard with copious quantities of water. Do not direct water jets straight onto the spillage. Keep clear of effluent. Clean the area thoroughly.
	Cargo Transport Units (large spillage)	<p>Keep bridge and living quarters upwind. Protect crew and living quarters against corrosive or toxic vapours by using water spray to drive vapours away.</p> <p>Wash overboard with copious quantities of water. Do not direct water jets straight onto the spillage. Keep clear of effluent. Clean the area thoroughly.</p>
Spillage under deck	Packages (small spillage)	<p>Provide adequate ventilation. Do not enter deck without self-contained breathing apparatus. Check atmosphere before entering (toxicity and explosion hazard). If atmosphere cannot be checked, do not enter. Let vapours evaporate, keep clear.</p> <p><i>Liquids:</i> Provide good ventilation of the space. Use water spray on effluent in hold to avoid ignition of flammable vapours. Wash down to the bottom of the hold. Use copious quantities of water. Pump overboard.</p> <p><i>Solids:</i> Collect spillage. Dispose of overboard. Wash residues down to the bottom of the hold. Use copious quantities of water. Pump overboard.</p>
	Cargo Transport Units (large spillage)	<p>Keep bridge and living quarters upwind. Protect crew and living quarters against corrosive or toxic vapours by using water spray to drive vapours away.</p> <p>Do not enter space. Keep clear. Radio for expert ADVICE. After hazard evaluation by experts, you may proceed.</p> <p>Provide adequate ventilation. Do not enter space without self-contained breathing apparatus. Check atmosphere before entering (toxicity and explosion hazard). If atmosphere cannot be checked, do not enter. Let vapours evaporate, keep clear. Where a ventilation system is used, particular attention should be taken in order to prevent toxic vapours or fumes entering occupied areas of the ship, e.g. living quarters, machinery spaces, working areas.</p> <p><i>Liquids:</i> Provide good ventilation of the space. Use water spray on effluent to avoid ignition of flammable vapours. Wash down to the bottom of the hold. Use copious quantities of water. Pump overboard.</p> <p><i>Solids:</i> Collect spillage. Dispose of overboard. Wash residues down to the bottom of the hold. Use copious quantities of water. Pump overboard.</p>
Special cases: Marine Pollutant Mark UN 2029, UN 3484		<p>Report incident according to MARPOL reporting requirements.</p> <p>Self-ignition of spilt material is possible.</p>

SPILLAGE SCHEDULE Delta

S–D

FLAMMABLE LIQUIDS

General comments		<p>Wear suitable protective clothing and self-contained breathing apparatus.</p> <p>Avoid all sources of ignition (e.g. naked lights, unprotected light bulbs, electric hand tools, friction).</p> <p>Stop leak if practicable.</p> <p>Avoid contact, even when wearing protective clothing. Spillage may evolve flammable vapours.</p> <p>Contaminated clothing must be washed off with water and then removed.</p>
Spillage on deck	Packages (small spillage)	Wash overboard with copious quantities of water. Do not direct water jet straight onto the spillage. Keep clear of effluent. Clean the area thoroughly.
	Cargo Transport Units (large spillage)	<p>Keep bridge and living quarters upwind.</p> <p>Wash overboard with copious quantities of water. Do not direct water jet straight onto the spillage. Keep clear of effluent. Clean the area thoroughly.</p>
Spillage under deck	Packages (small spillage)	<p>Shut off all possible sources of ignition in the space. Provide adequate ventilation. Do not enter space without self-contained breathing apparatus. Check atmosphere before entering (toxicity and explosion hazard). If the atmosphere cannot be checked, do not enter. Let vapours evaporate, keep clear.</p> <p>Provide good ventilation of the space. Use water spray on effluent in hold to avoid ignition of flammable vapours. Wash down to the bottom of the hold. Pump overboard.</p>
	Cargo Transport Units (large spillage)	<p>Keep bridge and living quarters upwind. Protect crew and living quarters against corrosive or toxic vapours by using water spray to drive vapours away.</p> <p>Do not enter space. Keep clear. Radio for expert ADVICE. After hazard evaluation by experts, you may proceed.</p> <p>Provide adequate ventilation. Do not enter space without self-contained breathing apparatus. Check atmosphere before entering (toxicity and explosion hazard). If atmosphere cannot be checked, do not enter. Let vapour evaporate, keep clear. Where a ventilation system is used, particular attention should be taken in order to prevent toxic vapours or fumes entering occupied areas of the vessel, e.g. living quarters, machinery spaces, working areas.</p> <p>Provide good ventilation of the space. Use water spray on effluent in the space to avoid ignition of flammable vapours. Wash down to the bottom of the hold. Use copious quantities of water. Pump overboard.</p>
Special cases:		
Marine Pollutant Mark		Report incident according to MARPOL reporting requirements.
UN 2749		Self-ignition of spilt material is possible.
UN 3359		This is a cargo transport unit under fumigation. When opened, it will be ventilated. However, experience has shown that toxic fumigants will stay within packaging material and in non-ventilated areas. Obtain information about the fumigation agent.
UN 3540		Substances might be spilled when the articles are damaged. Undamaged articles can be collected and repacked.

SPILLAGE SCHEDULE Echo

S–E

FLAMMABLE LIQUIDS, FLOATING ON WATER

General comments		<p>Avoid sources of ignition (e.g. naked lights, unprotected light bulbs, electric hand tools). Liquid is flammable and spillage may evolve flammable vapours.</p> <p>Wear suitable protective clothing and self-contained breathing apparatus.</p> <p>Stop leak if practicable.</p> <p>In general, substances covered under this schedule will have fuel-oil-like properties. They are immiscible with water and are liable to float on the surface of water. The use of inert absorbent material, as used in machinery spaces, is appropriate in all cases. For sticky liquids, shovels may be used, preferably shovels made of non-sparking or non-ferrous material.</p> <p>You may use light oil or soap-like products (surfactants) to clean small areas. Clean the area thoroughly because of the flammability hazard.</p> <p>Any pumping of spilled liquid overboard will create an oil spill on the sea surface. In this case, contact coastal authorities.</p> <p>Report discharge overboard according to MARPOL reporting requirements.</p>
Spillage on deck	Packages (small spillage)	Collect spillage in oil drums, metal boxes or salvage packagings. You may use inert absorbent material.
	Cargo Transport Units (large spillage)	<p>Restrict flow of leakage to an enclosed area (e.g. by diking with inert material or cement).</p> <p>Collect spillage in oil drums, metal boxes or salvage packagings. You may use inert absorbent material.</p> <p>Otherwise, wash overboard with copious quantities of water.</p>
Spillage under deck	Packages (small spillage)	<p>Shut off possible sources of ignition in the space. Provide adequate ventilation. Do not enter space without self-contained breathing apparatus. Check atmosphere before entering (toxicity and explosion hazard). If atmosphere cannot be checked, do not enter. Let vapours evaporate.</p> <p>Collect spillage in oil drums, metal boxes or salvage packagings. You may use inert absorbent material. Keep collected spillages in well ventilated areas or on deck only.</p>
	Cargo Transport Units (large spillage)	<p>Shut off possible sources of ignition in the space. Provide adequate ventilation. Do not enter deck without self-contained breathing apparatus. Check atmosphere before entering (toxicity and explosion hazard). If atmosphere cannot be checked, do not enter. Let vapours evaporate. Where a ventilation system is used, particular attention should be taken in order to prevent toxic vapours or fumes entering occupied areas of the ship, e.g. living quarters, machinery spaces, working areas.</p> <p>Provide good ventilation of the space. Use water spray on effluent in the space to avoid ignition of flammable vapours. Wash down to the bottom of the hold. Use copious quantities of water.</p> <p>Treat effluent according to Shipboard Oil Pollution Emergency Plan. Otherwise, radio for expert ADVICE.</p>
Special cases:		
UN 1136, UN 1993		These substances may be miscible with water and hence not float on the surface. In this case, SPILLAGE SCHEDULE S–D will be appropriate.
UN 1139, UN 1263, UN 1866		No thorough cleaning of spillage site necessary. Residues will dry out and coat surfaces.

SPILLAGE SCHEDULE Foxtrot

S-F

WATER-SOLUBLE MARINE POLLUTANTS

General comments		<p>Wear suitable protective clothing and self-contained breathing apparatus.</p> <p>Stop leak if practicable.</p> <p>Substances covered under this schedule will present a hazard to the marine environment. Try to avoid disposal overboard.</p> <p>The use of inert absorbent material, as used in machinery spaces, is appropriate in all cases. For sticky liquids, shovels may be used.</p> <p>Discharge of spilled substance overboard will damage the marine environment, including living resources of the sea. In this case, contact coastal authorities.</p> <p>Report discharge overboard according to MARPOL reporting requirements.</p>
Spillage on deck	Packages (small spillage)	<p><i>Liquids:</i> Smother spillage with inert absorbent material.</p> <p>Collect spillage in oil drums, metal boxes or salvage packagings.</p> <p><i>Solids:</i> Collect material.</p>
	Cargo Transport Units (large spillage)	<p>Restrict flow of leakage to an enclosed area (e.g. by barricading with inert material or cement if available).</p> <p><i>Liquids:</i> Collect spillage in empty tanks, oil drums, metal boxes or salvage packagings. You may use inert absorbent material.</p> <p><i>Solids:</i> Collect spillage in oil drums or metal boxes.</p>
Spillage under deck	Packages (small spillage)	<p><i>Liquids:</i> Smother spillage with inert absorbent material.</p> <p>Collect spillage in oil drums, metal boxes or salvage packagings.</p> <p><i>Solids:</i> Collect material.</p>
	Cargo Transport Units (large spillage)	<p>Restrict flow of leakage to an enclosed area (e.g. by barricading with inert material or cement if available).</p> <p><i>Liquids:</i> Collect spillage in empty tanks, oil drums, metal boxes or salvage packagings. You may use inert absorbent material.</p> <p><i>Solids:</i> Collect spillage in oil drums or metal boxes. Otherwise, wash down to the bottom of the hold. Use copious quantities of water. Treat effluent according to Shipboard Oil Pollution Emergency Plan.</p>
Special cases: None.		

SPILLAGE SCHEDULE Golf

S–G

FLAMMABLE SOLIDS AND SELF-REACTIVE SUBSTANCES

General comments		<p>Wear suitable protective clothing and self-contained breathing apparatus.</p> <p>Avoid all sources of ignition (e.g. naked lights, unprotected light bulbs, electric hand tools, friction). Wear non-sparking footwear.</p> <p>Stop leak if practicable.</p>
Spillage on deck	Packages (small spillage)	Wash overboard with copious quantities of water. Keep clear of effluent.
	Cargo Transport Units (large spillage)	
Spillage under deck	Packages (small spillage)	<p>Do not enter space without self-contained breathing apparatus.</p> <p>Check atmosphere before entering (toxicity and explosion hazard).</p> <p>Collect and contain spillage if practicable. Dispose of overboard.</p> <p>Collect spillage using soft brushes and plastic trays.</p>
	Cargo Transport Units (large spillage)	<p>Provide adequate ventilation.</p> <p>Do not enter space without self-contained breathing apparatus.</p> <p>Check atmosphere before entering (toxicity and explosion hazard).</p> <p>Collect and contain spillage if practicable. Dispose of overboard.</p> <p>Collect spillage using soft brushes and plastic trays.</p>
Special cases: UN 3541		<p>Substances might be spilled when the articles are damaged.</p> <p>Undamaged articles can be collected.</p>

SPILLAGE SCHEDULE Hotel

S-H

FLAMMABLE SOLIDS (MOLTEN MATERIAL)

General comments		<p>Wear suitable protective clothing and self-contained breathing apparatus.</p> <p>Avoid all sources of ignition (e.g. naked lights, unprotected light bulbs, electric hand tools, friction). Wear non-sparking footwear.</p> <p>Stop leak if practicable.</p> <p>Do not touch or walk on spilled material.</p>
Spillage on deck	Packages (small spillage)	Smother with dry inert material. Dispose of overboard.
	Cargo Transport Units (large spillage)	
Spillage under deck	Packages (small spillage)	
	Cargo Transport Units (large spillage)	
Special cases: None.		

SPILLAGE SCHEDULE India

S-I

FLAMMABLE SOLIDS (REPACKING POSSIBLE)

General comments		Wear suitable protective clothing and self-contained breathing apparatus. Avoid all sources of ignition (e.g. naked lights, unprotected light bulbs, electric hand tools, friction). Wear non-sparking footwear. Stop leak if practicable.
Spillage on deck	Packages (small spillage)	Collect spillage and repack if practicable. Otherwise, wash overboard with copious quantities of water. Keep clear of effluent.
	Cargo Transport Units (large spillage)	
Spillage under deck	Packages (small spillage)	Collect spillage and repack if practicable.
	Cargo Transport Units (large spillage)	
Special cases: None.		

SPILLAGE SCHEDULE Juliet

S–J

WETTED EXPLOSIVES AND CERTAIN SELF-HEATING SUBSTANCES

General comments		<p>Wear suitable protective clothing and self-contained breathing apparatus.</p> <p>Avoid all sources of ignition (e.g. naked lights, unprotected light bulbs, electric hand tools, friction). Wear non-sparking footwear.</p> <p>Stop leak if practicable.</p> <p>Dried out material may explode if exposed to heat, flame, friction or shock.</p>
Spillage on deck	Packages (small spillage)	<p>Keep spillage wet.</p> <p>Dispose of solid material overboard.</p> <p>Wash overboard with copious quantities of water. Keep clear of effluent.</p>
	Cargo Transport Units (large spillage)	
Spillage under deck	Packages (small spillage)	<p>Keep spillage wet.</p> <p>Collect and contain spillage if practicable. Dispose of overboard.</p> <p>Collect spillage using soft brushes and plastic trays.</p>
	Cargo Transport Units (large spillage)	
Special cases: UN 3542		<p>Substances might be spilled when the articles are damaged.</p> <p>Undamaged articles can be collected.</p>

SPILLAGE SCHEDULE Kilo

S-K

TEMPERATURE-CONTROLLED SELF-REACTIVE SUBSTANCES

General comments		<p>If smoke is observed, see FIRE SCHEDULE F-F.</p> <p>Check temperature reading if possible. If temperature is increasing: see FIRE SCHEDULE F-F.</p> <p>Wear suitable protective clothing and self-contained breathing apparatus.</p> <p>Avoid all sources of ignition (e.g. naked lights, unprotected light bulbs, electric hand tools, friction). Wear non-sparking footwear.</p>
Spillage on deck	Packages (small spillage)	Wash overboard with copious quantities of water. Keep clear of effluent.
	Cargo Transport Units (large spillage)	Wash overboard with copious quantities of water. Keep clear of effluent. Leave units closed.
Spillage under deck	Packages (small spillage)	Not applicable. According to the IMDG Code, under deck stowage not allowed. Radio for expert ADVICE.
	Cargo Transport Units (large spillage)	
Special cases: None.		

SPILLAGE SCHEDULE Lima

S-L

SPONTANEOUSLY COMBUSTIBLE, WATER-REACTIVE SUBSTANCES

General comments		Wear suitable protective clothing and self-contained breathing apparatus. Avoid all sources of ignition (e.g. naked lights, unprotected light bulbs, electric hand tools, friction). Wear non-sparking footwear. DO NOT USE WATER.
Spillage on deck	Packages (small spillage)	Avoid getting water on spilled substances or inside cargo transport units. Smother with dry inert material. Dispose of overboard immediately.
	Cargo Transport Units (large spillage)	
Spillage under deck	Packages (small spillage)	Not applicable. According to the IMDG Code, under deck stowage not allowed. Radio for expert ADVICE.
	Cargo Transport Units (large spillage)	
Special cases: UN 2210, UN 2968		These substances are allowed to be carried under deck. Take action as given for on deck stowage.

SPILLAGE SCHEDULE Mike

S-M

HAZARD OF SPONTANEOUS IGNITION

General comments		Substances covered by this schedule may ignite within 5 minutes after contact with air. See fire-fighting guidance: FIRE SCHEDULE F-G.
Spillage on deck	Packages (small spillage)	
	Cargo Transport Units (large spillage)	
Spillage under deck	Packages (small spillage)	
	Cargo Transport Units (large spillage)	
Special cases: UN 3542		Substances might be spilled when the articles are damaged. Undamaged articles can be collected.

SPILLAGE SCHEDULE November

S–N

SUBSTANCES REACTING VIGOROUSLY WITH WATER

General comments		<p>Wear suitable protective clothing and self-contained breathing apparatus.</p> <p>Avoid all sources of ignition (e.g. naked lights, unprotected light bulbs, electric hand tools, friction). Wear non-sparking footwear.</p> <p>Stop leak if practicable.</p>
Spillage on deck	Packages (small spillage)	<p>If dry, contain and collect spillage if practicable. Dispose of overboard.</p> <p>Avoid contact with water except to wash residues overboard with copious quantities of water. Keep clear of effluent.</p>
	Cargo Transport Units (large spillage)	
Spillage under deck	Packages (small spillage)	<p>Provide adequate ventilation.</p> <p>Check atmosphere before entering space (toxicity and explosion hazards). If atmosphere cannot be checked, do not enter. Do not enter space without self-contained breathing apparatus.</p> <p>Keep dry. Collect spillages using soft brushes and plastic trays.</p> <p><i>If dry</i>, collect and contain spillage if practicable. Dispose of overboard.</p> <p><i>If wet</i>, use inert absorbent material. Do not use combustible material. Dispose of overboard.</p>
	Cargo Transport Units (large spillage)	
Special cases: UN 3543		<p>Substances might be spilled when the articles are damaged.</p> <p>Undamaged articles can be collected</p>

SPILLAGE SCHEDULE Oscar

S-O

SUBSTANCES DANGEROUS WHEN WET (NON-COLLECTABLE ARTICLES)

General comments		<p>Wear suitable protective clothing and self-contained breathing apparatus.</p> <p>Avoid all sources of ignition (e.g. naked lights, unprotected light bulbs, electric hand tools, friction). Wear non-sparking footwear.</p> <p>Stop leak if practicable.</p>
Spillage on deck	Packages (small spillage)	Wash overboard with copious quantities of water. Keep clear of effluent.
	Cargo Transport Units (large spillage)	
Spillage under deck	Packages (small spillage)	<p>Do not enter space without self-contained breathing apparatus.</p> <p><i>If dry</i>, collect and contain spillage if practicable. Keep dry. Dispose of overboard. Avoid contact with water except to wash residues with copious quantities of water. Keep clear of effluent.</p> <p><i>If wet</i>, wash down to the bottom of the hold. Use copious quantities of water. Pump overboard. If gas is developing, provide good ventilation of the hold. Use water spray on effluent in hold to avoid ignition of flammable vapours.</p>
	Cargo Transport Units (large spillage)	<p>Do not enter space without self-contained breathing apparatus.</p> <p><i>If dry</i>, collect and contain spillage if practicable. Keep dry. Dispose of overboard. Avoid contact with water except to wash residues with copious quantities of water. Keep clear of effluent.</p> <p><i>If wet</i>, wash down to the bottom of the hold. Use copious quantities of water. Pump overboard. If gas is developing, provide good ventilation of the hold. Use water spray on effluent in hold to avoid ignition of flammable vapours. Where a ventilation system is used, particular attention should be taken in order to prevent toxic vapours or fumes entering occupied spaces of the ship, e.g. living quarters, machinery spaces, working areas.</p>
Special cases: UN 1295		Beware of a highly flammable atmosphere.

SPILLAGE SCHEDULE Papa

S-P

SUBSTANCES DANGEROUS WHEN WET (COLLECTABLE ARTICLES)

General comments		Wear suitable protective clothing and self-contained breathing apparatus.
Spillage on deck	Packages (small spillage)	Contain and collect spillage if practicable. Dispose of overboard.
	Cargo Transport Units (large spillage)	
Spillage under deck	Packages (small spillage)	Provide adequate ventilation. Do not enter space without self-contained breathing apparatus.
	Cargo Transport Units (large spillage)	Contain and collect spillages if practicable. Dispose of overboard.
Special cases: UN 3257, UN 3258 UN 3316 UN 3363, UN 3548		Hot substance. No hazard when cool. If FIRST AID KIT, collect articles and repack. Substances might be spilled when the articles or machinery are damaged. Undamaged articles can be collected. Take care of hazardous properties according to transport documents or radio for expert ADVICE.

SPILLAGE SCHEDULE Quebec

S-Q

OXIDIZING SUBSTANCES

General comments		<p>Wear suitable protective clothing and self-contained breathing apparatus.</p> <p>Avoid all sources of ignition (e.g. naked lights, unprotected light bulbs, electric hand tools, friction). Wear non-sparking footwear.</p> <p>May ignite combustible material (e.g. wood, paper, clothing).</p> <p>Stop leak if practicable.</p>
Spillage on deck	Packages (small spillage)	Wash overboard with copious quantities of water. Keep clear of effluent.
	Cargo Transport Units (large spillage)	
Spillage under deck	Packages (small spillage)	<p>Do not enter space without self-contained breathing apparatus.</p> <p><i>If dry</i>, contain and collect spillage if practicable. Dispose of overboard.</p> <p><i>If wet</i>, use inert absorbent material. Do not use combustible material.</p> <p><i>If liquid</i>, wash down to the bottom of the hold, using copious quantities of water. Pump overboard.</p> <p>Dispose of overboard.</p>
	Cargo Transport Units (large spillage)	<p>Provide adequate ventilation.</p> <p>Do not enter space without self-contained breathing apparatus.</p> <p><i>If dry</i>, contain and collect spillage if practicable. Dispose of overboard.</p> <p><i>If wet</i>, use inert absorbent material. Do not use combustible material.</p> <p><i>If liquid</i>, wash down to the bottom of the hold, using copious quantities of water. Pump overboard.</p> <p>Dispose of overboard.</p>
Special cases: UN 3544		<p>Substances might be spilled when the articles are damaged.</p> <p>Undamaged articles can be collected</p>

SPILLAGE SCHEDULE Romeo

S-R

ORGANIC PEROXIDES

General comments		<p>Wear suitable protective clothing and self-contained breathing apparatus.</p> <p>Contact of substance (or vapour) with eyes may cause blindness within minutes.</p> <p>Avoid all sources of ignition (e.g. naked lights, unprotected light bulbs, electric hand tools, friction). Wear non-sparking footwear.</p> <p>Stop leak if practicable.</p> <p>Substances covered by this schedule are liable to explode by exposure to heat or ignition.</p> <p>In case of <i>smoke evolution</i>, see appropriate FIRE SCHEDULE.</p> <p>Radio for expert ADVICE or contact manufacturer.</p>
Spillage on deck	Packages (small spillage)	<p>Wash overboard with copious quantities of water. Keep clear of effluent.</p> <p>Collect damaged or leaking receptacles and dispose of overboard.</p> <p>Handle with care.</p>
	Cargo Transport Units (large spillage)	
Spillage under deck	Packages (small spillage)	<p>Not applicable. According to the IMDG Code, under deck stowage not allowed. Radio for expert ADVICE.</p>
	Cargo Transport Units (large spillage)	
Special cases: UN 3545		<p>Substances might be spilled when the articles are damaged.</p> <p>Undamaged articles can be collected.</p>

SPILLAGE SCHEDULE Sierra

(Part 1 of 2)

S–S

RADIOACTIVE MATERIAL

General comments		<p>Evacuate compartment or downwind area of non-essential personnel.</p> <p>Provide respiratory protection to personnel in downwind area.</p> <p>For ships carrying radiation monitoring equipment, measure radiation levels. In this case, assess the extent of contamination and resultant radiation level of the package, the adjacent areas and, if necessary, all other material which has been carried in the conveyance.</p> <p>Define a zone for restricted entry. Personnel should not enter this zone without suitable protective clothing and self-contained breathing apparatus.</p> <p>Limit entry of personnel to the restricted zone for the shortest time possible.</p> <p>Cover liquid spill with inert absorbent materials, if available. Cover powder spills with plastic sheet or tarpaulin to minimize spread.</p> <p>If exposure of personnel is suspected, clean body and hair with warm water and soap; discharge resultant washings directly overboard.</p> <p>Record the names of potentially exposed persons. Ensure medical examination of these persons after reaching any medical staff.</p> <p>Emergency procedures, if established for the ship or the specific cargo by relevant authorities or the shipper, should be followed.</p> <p>For ships carrying radiation monitoring equipment, continue monitoring the radiation levels. Radio for expert ADVICE.</p>
Spillage on deck	Packages (small spillage)	<p>Wash spillages overboard with copious quantities of water. Keep clear of effluent.</p> <p>Packages damaged or leaking radioactive contents may be removed to an acceptable restricted access interim location. Isolate and sheet over. Do not remove packages from restricted access zone until approved by the competent authority.</p>
	Cargo Transport Units (large spillage)	<p>Let released gas escape. Keep clear. Use water spray to protect bridge, living quarters and personnel from precipitation of vapours (water curtain).</p> <p>Absorb liquid spillage, where practicable, using absorbent material. Isolate and sheet over.</p> <p>Packages damaged or leaking radioactive contents may be removed to an acceptable restricted access interim location. Isolate and sheet over. Do not remove packages from restricted access zone until approved by the competent authority.</p> <p>Wash residues of liquids or solids overboard with copious quantities of water (use spray nozzles). Do not allow water to enter receptacles.</p>
Spillage under deck	Packages (small spillage)	<p>Provide adequate ventilation.</p> <p>Let released gas escape, keep clear. Where a ventilation system is used, particular attention should be taken in order to prevent radioactive vapours or fumes entering occupied areas of the ship, e.g. living quarters, machinery spaces, working areas.</p> <p>Keep solids dry.</p> <p>Absorb liquid spillage, where practicable, using inert absorbent material. Isolate and sheet over.</p> <p>Packages damaged or leaking radioactive contents may be removed to an acceptable restricted access interim location. Isolate and sheet over. Do not remove packages from restricted access zone until approved by the competent authority.</p> <p>Keep working period of emergency team in space as short as possible.</p>
	Cargo Transport Units (large spillage)	<p>Do not enter space. Radio for expert ADVICE.</p> <p><i>If liquid, or vapour is developing:</i> Where a ventilation system is used, particular attention should be taken in order to prevent radioactive vapours entering occupied areas of the ship, e.g. living quarters, machinery spaces, working areas. Use water spray to protect bridge, living quarters and personnel from precipitation of vapours evolving from the hold (water curtain).</p>

SPILLAGE SCHEDULE Sierra (continued)

(Part 2 of 2)

**S-S
RADIOACTIVE MATERIAL**

<p>Special cases: UN 2977, UN 2978, UN 3507</p>	<p>Avoid contact, even when wearing protective clothing. Keep clear of evolving vapours. Even short-time inhalation of small quantities of vapour can cause breathing difficulties. Bear in mind that gases are heavier than air. Measures should be taken to prevent leaking gases from penetrating into any other part of the ship. Keep bridge and living quarters upwind. Protect crew and living quarters against corrosive and toxic vapours by using water spray to drive vapours away. Do not enter space without protective equipment. Keep clear. Radio for expert ADVICE.</p>
<p>UN 2919, UN 3331</p>	<p>For radioactive material, <i>transported under special arrangement</i>, use special precautions, operational controls or emergency procedures as specifically designated by the competent authorities in their approval certificates and declared by the shipper in its transport documents.</p>
<p>Subsidiary labels class 4.2 or class 4.3</p>	<p>These are pyrophoric substances, water will ignite the material. DO NOT USE WATER. Radio for expert ADVICE.</p>
<p>Re-stowing of packages UN 2977, UN 3324, UN 3325, UN 3326, UN 3327, UN 3328, UN 3329, UN 3330, UN 3331</p>	<p>Check package labels and transport documents to determine whether packages contain fissile material. Prior to any re-stowing of these packages, radio for expert ADVICE.</p>
<p>UN 3332, UN 3333</p>	<p>If a special form radioactive material is identified as being outside its packaging, do not touch. Stay away and radio for expert ADVICE.</p>

SPILLAGE SCHEDULE Tango

S-T

DANGEROUS GOODS WITH BIOHAZARD

General comments		<p>Wear suitable protective clothing and self-contained breathing apparatus.</p> <p>Avoid handling leaking or damaged packages or keep handling to a minimum.</p> <p>Inform the public health, veterinary or other competent authority if persons or the marine environment might have been exposed. A competent authority to which actual or suspected leakage is reported should notify the authorities of any countries in which the goods may have been handled, including countries of transit.</p> <p>Radio for expert ADVICE.</p> <p>Notify consignor/consignee.</p>
Spillage on deck	Packages (small spillage)	<p>Stop leak if practicable.</p> <p>Collect potentially contaminated packages or equipment. Isolate and sheet over.</p> <p>Wash spillage or residues overboard with copious quantities of water. Keep clear of effluent.</p>
	Cargo Transport Units (large spillage)	<p>Clean contaminated area thoroughly using bleach-like products (like sodium hypochlorite 1-6% solution or Javel water). Keep clear of effluent.</p>
Spillage under deck	Packages (small spillage)	Do not enter space.
	Cargo Transport Units (large spillage)	
Special cases: None.		

SPILLAGE SCHEDULE Uniform

(Part 1 of 2)

S-U

GASES (FLAMMABLE, TOXIC OR CORROSIVE)

General comments		<p>Spaces and areas where leakages or spillages have occurred should be evacuated downwind immediately.</p> <p>Take care: Flames may be invisible. Leaking gas may be extremely cold.</p> <p>Measures should be taken to prevent leaking gases from penetrating into any other part of the ship. Bear in mind that some gases are heavier than air or may otherwise accumulate in lower or non-ventilated parts of the ship. Ensure that there is no smoking or any other open fire on board unless the leak has been closed and all spaces have been ventilated. Particular attention should be taken in order to prevent gases drifting into occupied areas of the ship, e.g. living quarters, machinery spaces, working areas.</p> <p>Wear protective clothing suitable for gas protection and self-contained breathing apparatus.</p> <p>Avoid all sources of ignition (e.g. naked lights, unprotected light bulbs, electric hand tools, friction). Wear non-sparking footwear.</p> <p>Even short inhalation of small quantities of gas can cause breathing difficulties. Keep clear of evolving gases. Avoid all skin contact.</p> <p>Let <i>spilt liquefied gas</i> evaporate. When in contact with cold liquefied gases, most materials become brittle and are likely to break without warning. Avoid all contact, even when wearing protective clothing. If practicable, protect ship's superstructure with copious quantities of water. Do not direct water jet onto the spill.</p>
Spillage on deck	Packages (small spillage)	Let gas dissipate. Keep clear.
	Cargo Transport Units (large spillage)	<p>Let gas dissipate. Keep bridge and living quarters upwind.</p> <p>Otherwise, protect crew and living quarters against flammable or toxic gases by using water spray to drive gases away (water curtain).</p> <p><i>Spilt liquefied gas</i>: Use water jets from as far as practicable to accelerate evaporation, not directing them straight onto the spill.</p>
Spillage under deck	Packages (small spillage)	<p>Do not enter space. Provide adequate ventilation.</p> <p>Where a ventilation system is used, particular attention should be taken in order to prevent gases penetrating into other areas of the ship.</p> <p>Let gas evaporate. Keep clear. Radio for expert ADVICE.</p> <p>Check atmosphere before entering (toxicity and explosion hazard). Do not enter space without self-contained breathing apparatus.</p>
	Cargo Transport Units (large spillage)	<p>Do not enter space. Provide adequate ventilation.</p> <p>Where a ventilation system is used, particular attention should be taken in order to prevent gases drifting into other areas of the ship.</p> <p>Keep bridge and living quarters upwind.</p> <p>Otherwise, protect crew and living quarters against flammable or toxic gases by using water spray to drive gases away (water curtain).</p> <p>If practicable, use water spray to avoid ignition of flammable gases in the space. Radio for expert ADVICE.</p> <p>Check atmosphere before entering (toxicity and explosion hazard). Do not enter deck without self-contained breathing apparatus.</p>

SPILLAGE SCHEDULE Uniform (confirmed)

(Part 2 of 2)

S-U

GASES (FLAMMABLE, TOXIC OR CORROSIVE)

Special cases: UN 1001, UN 3374	Heated or roughly handled receptacles may explode even after several hours of being removed from external sources of heat. Cool for several hours by using water.
UN 1614	The gas is absorbed in a porous inert material, but will evaporate if the receptacle is damaged.
UN 3501	A flammable liquid, paste or powder may be expelled if the package is ruptured. Also consult SPILLAGE SCHEDULES S-D or S-G, as appropriate.
UN 3504	A flammable or toxic liquid, paste or powder may be expelled if the package is ruptured. Also consult SPILLAGE SCHEDULES S-D, S-G or S-A, as appropriate.
UN 3505	A flammable or corrosive liquid, paste or powder may be expelled if the package is ruptured. Also consult SPILLAGE SCHEDULES S-C or S-G, as appropriate.
UN 3537, UN 3539	Gases might be released when the articles are damaged. Undamaged articles can be collected and repacked.

SPILLAGE SCHEDULE Victor

S-V

GASES (NON-FLAMMABLE, NON-TOXIC)

General comments		<p>Measures should be taken to prevent leaking gases from penetrating into any other part of the ship. Bear in mind that some gases are heavier than air or may otherwise accumulate in lower or non-ventilated parts of the ship. Particular attention should be taken in order to prevent gases drifting into occupied areas of the ship, e.g. living quarters, machinery spaces, working areas. Leaking gas may be extremely cold.</p> <p>Wear suitable protective clothing and self-contained breathing apparatus (suffocation hazard).</p> <p>Let <i>spilt liquefied gas</i> evaporate. When in contact with cold liquefied gases, most materials become brittle and are likely to break without warning. Avoid all contact, even when wearing protective clothing. If practicable, protect ship's superstructure with copious quantities of water. Do not direct water jet onto the spill.</p>
Spillage on deck	Packages (small spillage)	Let gas dissipate. Keep clear.
	Cargo Transport Units (large spillage)	<p>Let gas dissipate.</p> <p><i>Spilt liquefied gas</i>: Use water jets from as far as practicable to accelerate evaporation, not directing them straight onto the spill.</p> <p>Keep clear of evolving gases.</p>
Spillage under deck	Packages (small spillage)	<p>Provide adequate ventilation.</p> <p>Stop leak if practicable. Otherwise, let gas evaporate. Keep clear.</p> <p>Check atmosphere before entering space (suffocation hazard). Do not enter space without self-contained breathing apparatus.</p>
	Cargo Transport Units (large spillage)	<p>Provide adequate ventilation.</p> <p>Stop leak if practicable. Otherwise, let gas evaporate. Keep clear.</p> <p><i>Spilt liquefied gas</i>: Use water jets from as far as practicable to accelerate evaporation, not directing them straight onto the spill.</p> <p>Check atmosphere before entering space (suffocation hazard). Do not enter space without self-contained breathing apparatus.</p>
Special cases:		
UN 2990, UN 3072		No suffocation hazard. Collect articles and repack.
UN 3502		A toxic liquid, paste or powder may be expelled if the package is ruptured. Also consult SPILLAGE SCHEDULE S-A.
UN 3503		A corrosive liquid, paste or powder may be expelled if the package is ruptured. Also consult SPILLAGE SCHEDULES S-C or S-G, as appropriate.
UN 3538		<p>Gases might be released when the articles are damaged.</p> <p>Undamaged articles can be collected and repacked.</p>

SPILLAGE SCHEDULE Whisky

S–W

OXIDIZING GASES

General comments		<p>Areas containing leakages or spillages should be evacuated downwind immediately. These gases may ignite combustible material and enhance fire.</p> <p>Take care: Flames may be invisible. Leaking gas may be extremely cold.</p> <p>Measures should be taken to prevent leaking gases from penetrating into any other part of the ship.</p> <p>Ensure that there is no smoking or any other open fire on board unless the leak has been closed and all spaces have been ventilated. Particular attention should be taken in order to prevent gases drifting into occupied areas of the vessel, e.g. living quarters, machinery spaces, working areas.</p> <p>Wear suitable protective clothing and self-contained breathing apparatus.</p> <p>Avoid all sources of ignition (e.g. naked lights, unprotected light bulbs, electric hand tools, friction). Wear non-sparking footwear.</p> <p>Even short inhalation of small quantities of gas can cause breathing difficulties. Keep clear of evolving gases. Avoid all skin contact.</p> <p>Let <i>spilt liquefied gas</i> evaporate. When in contact with cold liquefied gases, most materials become brittle and are likely to break without warning. Avoid all contact, even when wearing protective clothing. If practicable, protect ship's superstructure with copious quantities of water. Do not direct water jet onto the spill.</p>
Spillage on deck	Packages (small spillage)	Let gas evaporate. Keep clear.
	Cargo Transport Units (large spillage)	<p>Let gas evaporate.</p> <p>Keep bridge and living quarters upwind.</p> <p>Otherwise, protect crew and living quarters against flammable or toxic gases by using water spray to drive gases away (water curtain).</p> <p><i>Spilt liquefied gas</i>: Use water jets from as far as practicable to accelerate evaporation, not directing them straight onto the spill.</p>
Spillage under deck	Packages (small spillage)	<p>Do not enter space.</p> <p>Provide adequate ventilation.</p> <p>Where a ventilation system is used, particular attention should be observed in order to prevent gases penetrating into other areas of the ship.</p> <p>Let gas evaporate. Keep clear.</p> <p>Radio for expert ADVICE.</p> <p>Check atmosphere before entering space (toxicity and explosion hazard). Do not enter space without self-contained breathing apparatus.</p>
	Cargo Transport Units (large spillage)	<p>Do not enter space.</p> <p>Provide adequate ventilation.</p> <p>Where a ventilation system is used, particular attention should be observed in order to prevent gases drifting into other areas of the ship.</p> <p>Keep bridge and living quarters upwind.</p> <p>Otherwise, protect crew and living quarters against gases by using water spray to drive gases away (water curtain).</p> <p>If practicable, use water spray to avoid ignition of gases in the space.</p> <p>Radio for expert ADVICE.</p>
Special cases: UN 1072, UN 1073		<p>This is concentrated oxygen. No inhalation hazard after a short distance from a leak.</p> <p>No skin irritation hazard.</p>

SPILLAGE SCHEDULE X-Ray

S-X

EXPLOSIVE ITEMS AND ARTICLES

General comments		Avoid all sources of ignition (e.g. naked lights, unprotected light bulbs, electric hand tools). <i>Electrostatic hazard:</i> Electric charge may ignite ammunition. Keep spilled material away from generators of static electricity (e.g. mobile phones, friction of synthetic polymers like PVC gloves). Wear non-sparking footwear.
Spillage on deck	Packages (small spillage)	<i>Articles:</i> Sweep or pick up articles. If the articles remain intact but appear damaged, separate out and radio for expert ADVICE. <i>Spilled substance:</i> Keep wet. Wash spillage overboard with copious quantities of water.
	Cargo Transport Units (large spillage)	
Spillage under deck	Packages (small spillage)	<i>Articles:</i> Sweep or pick up articles. If the articles remain intact but appear damaged, separate and radio for expert ADVICE. <i>Spilled substance:</i> Keep wet. Collect spillage where practicable. Dispose of overboard.
	Cargo Transport Units (large spillage)	
Special cases: None.		

SPILLAGE SCHEDULE Yankee

S–Y

EXPLOSIVE CHEMICALS

General comments		<p>Avoid all sources of ignition (e.g. naked lights, unprotected light bulbs, electric hand tools). Stop leak if practicable.</p> <p><i>Electrostatic hazard:</i> Electric charge may ignite ammunition. Keep spilled material away from generators of static electricity (e.g. mobile phones, friction of synthetic polymers like PVC gloves). Wear non-sparking footwear.</p> <p>Some explosive mixtures are stabilized in such a way that water will separate explosives from the stabilizer, thus creating a higher risk. The explosive component becomes very sensitive to shock and heat.</p> <p>Radio for expert ADVICE.</p>
Spillage on deck	Packages (small spillage)	<p><i>Articles:</i> Sweep or pick up articles. If the articles remain intact but appear damaged, separate out and ask for expert ADVICE. Wetted articles should be jettisoned.</p> <p><i>Spilled substance:</i> Keep it under water. Wash spillages overboard with copious quantities of water.</p>
	Cargo Transport Units (large spillage)	
Spillage under deck	Packages (small spillage)	<p><i>Articles:</i> Sweep or pick up articles. If the articles remain intact but appear damaged, separate out and radio for expert ADVICE. Wetted articles should be jettisoned.</p> <p><i>Spilled substance:</i> Keep it under water. Collect spillages where practicable. Dispose of overboard.</p>
	Cargo Transport Units (large spillage)	
Special cases: None.		

SPILLAGE SCHEDULE Zulu

S-Z

TOXIC EXPLOSIVES

General comments		<p>Wear suitable protective clothing and self-contained breathing apparatus.</p> <p>Even short inhalation of small quantities of gas can cause breathing difficulties or lead to severe poisoning.</p> <p>Avoid all sources of ignition (e.g. naked lights, unprotected light bulbs, electric hand tools).</p> <p><i>Electrostatic hazard:</i> Electric charge may ignite ammunition. Keep spilled material away from generators of static electricity (e.g. mobile phones, friction of synthetic polymers like PVC gloves). Wear non-sparking footwear.</p> <p>Particular attention should be taken in order to prevent developing gases drifting into occupied areas of the ship, e.g. living quarters, machinery, working areas.</p> <p>Keep bridge and living quarters upwind. Otherwise, protect crew and living quarters against gases by using water spray to drive gases away (water curtain).</p> <p>Radio for expert ADVICE.</p>
Spillage on deck	Packages (small spillage)	<p>Let vapours dissipate, keep clear.</p> <p><i>Articles:</i> Sweep or pick up articles. If the articles remain intact but appear damaged, separate out and ask for expert ADVICE.</p>
	Cargo Transport Units (large spillage)	<p><i>Spilled substance:</i> Keep wet. Wash spillage overboard with copious quantities of water. Keep clear of effluent.</p>
Spillage under deck	Packages (small spillage)	<p>Do not enter space without self-contained breathing apparatus. Check atmosphere before entering. Let vapours dissipate, keep clear.</p> <p><i>Articles:</i> Sweep or pick up articles. If the articles remain intact but appear damaged, separate out and ask for expert ADVICE.</p>
	Cargo Transport Units (large spillage)	<p><i>Spilled substance:</i> Keep wet. Collect spillages where practicable. Dispose of overboard.</p>
Special cases: None.		

Index

Each current UN substance identification number (UN number) is allocated to EmS Fire and Spillage Schedules as shown below. Underlined EmS codes (special cases) indicate a substance, material or article for which additional advice is given in the emergency response procedures.

UN No.	EmS Fire	EmS Spill	UN No.	EmS Fire	EmS Spill	UN No.	EmS Fire	EmS Spill
0004	F-B	S-Y	0066	F-B	S-X	0135	F-B	S-Y
0005	F-B	S-X	0070	F-B	S-X	0136	F-B	S-X
0006	F-B	S-X	0072	F-B	S-Y	0137	F-B	S-X
0007	F-B	S-X	0073	F-B	S-X	0138	F-B	S-X
0009	F-B	S-X	0074	F-B	S-Y	0143	F-B	S-Z
0010	F-B	S-X	0075	F-B	S-Y	0144	F-B	S-Y
0012	F-B	S-X	0076	F-B	S-Z	0146	F-B	S-Y
0014	F-B	S-X	0077	F-B	S-Z	0147	F-B	S-Y
0015	F-B	S-X	0078	F-B	S-Y	0150	F-B	S-Y
0016	F-B	S-X	0079	F-B	S-Y	0151	F-B	S-Y
0018	<u>F-B</u>	S-Z	0081	F-B	S-Y	0153	F-B	S-Y
0019	<u>F-B</u>	S-Z	0082	F-B	S-Y	0154	F-B	S-Y
0020	<u>F-B</u>	S-Z	0083	F-B	S-Y	0155	F-B	S-Y
0021	<u>F-B</u>	S-Z	0084	F-B	S-Y	0159	F-B	S-Y
0027	F-B	S-Y	0092	F-B	S-X	0160	F-B	S-Y
0028	F-B	S-Y	0093	F-B	S-X	0161	F-B	S-Y
0029	F-B	S-X	0094	F-B	S-Y	0167	F-B	S-X
0030	F-B	S-X	0099	F-B	S-X	0168	F-B	S-X
0033	F-B	S-X	0101	F-B	S-X	0169	F-B	S-X
0034	F-B	S-X	0102	F-B	S-X	0171	F-B	S-X
0035	F-B	S-X	0103	F-B	S-X	0173	F-B	S-X
0037	F-B	S-X	0104	F-B	S-X	0174	F-B	S-X
0038	F-B	S-X	0105	F-B	S-X	0180	F-B	S-X
0039	F-B	S-X	0106	F-B	S-X	0181	F-B	S-X
0042	F-B	S-X	0107	F-B	S-X	0182	F-B	S-X
0043	F-B	S-X	0110	F-B	S-X	0183	F-B	S-X
0044	F-B	S-X	0113	F-B	S-Y	0186	F-B	S-X
0048	F-B	S-X	0114	F-B	S-Y	0190	F-B	S-X
0049	F-B	S-X	0118	F-B	S-Y	0191	F-B	S-X
0050	F-B	S-X	0121	F-B	S-X	0192	F-B	S-X
0054	F-B	S-X	0124	F-B	S-X	0193	F-B	S-X
0055	F-B	S-X	0129	F-B	S-Y	0194	F-B	S-X
0056	F-B	S-X	0130	F-B	S-Y	0195	F-B	S-X
0059	F-B	S-X	0131	F-B	S-X	0196	F-B	S-X
0060	F-B	S-X	0132	F-B	S-Y	0197	F-B	S-X
0065	F-B	S-X	0133	F-B	S-Y	0204	F-B	S-X

UN No.	EmS Fire	EmS Spill	UN No.	EmS Fire	EmS Spill	UN No.	EmS Fire	EmS Spill
0207	F-B	S-Y	0280	F-B	S-X	0334	F-B	S-X
0208	F-B	S-Y	0281	F-B	S-X	0335	F-B	S-X
0209	F-B	S-Y	0282	F-B	S-Y	0336	F-B	S-X
0212	F-B	S-X	0283	F-B	S-X	0337	F-B	S-X
0213	F-B	S-Y	0284	F-B	S-X	0338	F-B	S-X
0214	F-B	S-Y	0285	F-B	S-X	0339	F-B	S-X
0215	F-B	S-Y	0286	F-B	S-X	0340	F-B	S-Y
0216	F-B	S-Y	0287	F-B	S-X	0341	F-B	S-Y
0217	F-B	S-Y	0288	F-B	S-X	0342	F-B	S-Y
0218	F-B	S-Y	0289	F-B	S-X	0343	F-B	S-Y
0219	F-B	S-Y	0290	F-B	S-X	0344	F-B	S-X
0220	F-B	S-Y	0291	F-B	S-X	0345	F-B	S-X
0221	F-B	S-X	0292	F-B	S-X	0346	F-B	S-X
0222	F-B	S-Y	0293	F-B	S-X	0347	F-B	S-X
0224	F-B	S-Z	0294	F-B	S-X	0348	F-B	S-X
0225	F-B	S-X	0295	F-B	S-X	0349	F-B	S-X
0226	F-B	S-Y	0296	F-B	S-X	0350	F-B	S-X
0234	F-B	S-Z	0297	F-B	S-X	0351	F-B	S-X
0235	F-B	S-Y	0299	F-B	S-X	0352	F-B	S-X
0236	F-B	S-Y	0300	F-B	S-X	0353	F-B	S-X
0237	F-B	S-X	0301	<u>F-B</u>	S-Z	0354	F-B	S-X
0238	F-B	S-X	0303	F-B	S-X	0355	F-B	S-X
0240	F-B	S-X	0305	F-B	S-Y	0356	F-B	S-X
0241	F-B	S-X	0306	F-B	S-X	0357	F-B	S-Y
0242	F-B	S-X	0312	F-B	S-X	0358	F-B	S-Y
0243	F-B	S-X	0313	F-B	S-X	0359	F-B	S-Y
0244	F-B	S-X	0314	F-B	S-X	0360	F-B	S-X
0245	F-B	S-X	0315	F-B	S-X	0361	F-B	S-X
0246	F-B	S-X	0316	F-B	S-X	0362	F-B	S-X
0247	F-B	S-X	0317	F-B	S-X	0363	F-B	S-X
0248	<u>F-B</u>	S-Y	0318	F-B	S-X	0364	F-B	S-X
0249	<u>F-B</u>	S-Y	0319	F-B	S-X	0365	F-B	S-X
0250	F-B	S-X	0320	F-B	S-X	0366	F-B	S-X
0254	F-B	S-X	0321	F-B	S-X	0367	F-B	S-X
0255	F-B	S-X	0322	F-B	S-X	0368	F-B	S-X
0257	F-B	S-X	0323	F-B	S-X	0369	F-B	S-X
0266	F-B	S-Y	0324	F-B	S-X	0370	F-B	S-X
0267	F-B	S-X	0325	F-B	S-X	0371	F-B	S-X
0268	F-B	S-X	0326	F-B	S-X	0372	F-B	S-X
0271	F-B	S-X	0327	F-B	S-X	0373	F-B	S-X
0272	F-B	S-X	0328	F-B	S-X	0374	F-B	S-X
0275	F-B	S-X	0329	F-B	S-X	0375	F-B	S-X
0276	F-B	S-X	0330	F-B	S-X	0376	F-B	S-X
0277	F-B	S-X	0331	F-B	S-Y	0377	F-B	S-X
0278	F-B	S-X	0332	F-B	S-Y	0378	F-B	S-X
0279	F-B	S-X	0333	F-B	S-X	0379	F-B	S-X

UN No.	EmS Fire	EmS Spill	UN No.	EmS Fire	EmS Spill	UN No.	EmS Fire	EmS Spill
0380	F-B	S-X	0429	F-B	S-X	0475	F-B	S-Y
0381	F-B	S-X	0430	F-B	S-X	0476	F-B	S-Y
0382	F-B	S-X	0431	F-B	S-X	0477	F-B	S-Y
0383	F-B	S-X	0432	F-B	S-X	0478	F-B	S-Y
0384	F-B	S-X	0433	F-B	S-Y	0479	F-B	S-Y
0385	F-B	S-Y	0434	F-B	S-X	0480	F-B	S-Y
0386	F-B	S-Y	0435	F-B	S-X	0481	F-B	S-Y
0387	F-B	S-Y	0436	F-B	S-X	0482	F-B	S-Y
0388	F-B	S-Y	0437	F-B	S-X	0483	F-B	S-Y
0389	F-B	S-Y	0438	F-B	S-X	0484	F-B	S-Y
0390	F-B	S-Y	0439	F-B	S-X	0485	F-B	S-Y
0391	F-B	S-Y	0440	F-B	S-X	0486	F-B	S-X
0392	F-B	S-Y	0441	F-B	S-X	0487	F-B	S-X
0393	F-B	S-Y	0442	F-B	S-X	0488	F-B	S-X
0394	F-B	S-Y	0443	F-B	S-X	0489	F-B	S-Y
0395	F-B	S-X	0444	F-B	S-X	0490	F-B	S-Y
0396	F-B	S-X	0445	F-B	S-X	0491	F-B	S-X
0397	F-B	S-X	0446	F-B	S-X	0492	F-B	S-X
0398	F-B	S-X	0447	F-B	S-X	0493	F-B	S-X
0399	F-B	S-X	0448	F-B	S-Y	0494	F-B	S-X
0400	F-B	S-X	0449	F-B	S-X	0495	F-B	S-Y
0401	F-B	S-Y	0450	F-B	S-X	0496	F-B	S-Y
0402	F-B	S-Y	0451	F-B	S-X	0497	F-B	S-Y
0403	F-B	S-X	0452	F-B	S-X	0498	F-B	S-Y
0404	F-B	S-X	0453	F-B	S-X	0499	F-B	S-Y
0405	F-B	S-X	0454	F-B	S-X	0500	F-B	S-X
0406	F-B	S-Y	0455	F-B	S-X	0501	F-B	S-Y
0407	F-B	S-Y	0456	F-B	S-X	0502	F-B	S-X
0408	F-B	S-X	0457	F-B	S-X	0503	F-B	S-X
0409	F-B	S-X	0458	F-B	S-X	0504	F-B	S-Y
0410	F-B	S-X	0459	F-B	S-X	0505	F-B	S-X
0411	F-B	S-Y	0460	F-B	S-X	0506	F-B	S-X
0412	F-B	S-X	0461	F-B	S-X	0507	F-B	S-X
0413	F-B	S-X	0462	F-B	S-X	0508	F-B	S-Y
0414	F-B	S-X	0463	F-B	S-X	0509	F-B	S-Y
0415	F-B	S-X	0464	F-B	S-X	0510	F-B	S-X
0417	F-B	S-X	0465	F-B	S-X	1001	<u>F-D</u>	<u>S-U</u>
0418	F-B	S-X	0466	F-B	S-X	1002	F-C	S-V
0419	F-B	S-X	0467	F-B	S-X	1003	<u>F-C</u>	S-W
0420	F-B	S-X	0468	F-B	S-X	1005	F-C	S-U
0421	F-B	S-X	0469	F-B	S-X	1006	F-C	S-V
0424	F-B	S-X	0470	F-B	S-X	1008	F-C	S-U
0425	F-B	S-X	0471	F-B	S-X	1009	F-C	S-V
0426	F-B	S-X	0472	F-B	S-X	1010	F-D	S-U
0427	F-B	S-X	0473	F-B	S-Y	1011	F-D	S-U
0428	F-B	S-X	0474	F-B	S-Y	1012	F-D	S-U

UN No.	EmS Fire	EmS Spill	UN No.	EmS Fire	EmS Spill	UN No.	EmS Fire	EmS Spill
1013	F-C	S-V	1071	F-D	S-U	1135	F-E	S-D
1016	F-D	S-U	1072	<u>F-C</u>	<u>S-W</u>	1136	F-E	<u>S-E</u>
1017	F-C	S-U	1073	<u>F-C</u>	<u>S-W</u>	1139	F-E	<u>S-E</u>
1018	F-C	S-V	1075	<u>F-D</u>	S-U	1143	F-E	S-D
1020	F-C	S-V	1076	F-C	S-U	1144	F-E	S-D
1021	F-C	S-V	1077	F-D	S-U	1145	F-E	S-D
1022	F-C	S-V	1078	F-C	S-V	1146	F-E	S-D
1023	F-D	S-U	1079	F-C	S-U	1147	F-E	S-D
1026	F-D	S-U	1080	F-C	S-V	1148	F-E	S-D
1027	F-D	S-U	1081	F-D	S-U	1149	F-E	S-D
1028	F-C	S-V	1082	F-D	S-U	1150	F-E	S-D
1029	F-C	S-V	1083	F-D	S-U	1152	F-E	S-D
1030	F-D	S-U	1085	F-D	S-U	1153	F-E	S-D
1032	F-D	S-U	1086	F-D	S-U	1154	F-E	S-C
1033	F-D	S-U	1087	F-D	S-U	1155	F-E	S-D
1035	F-D	S-U	1088	F-E	S-D	1156	F-E	S-D
1036	F-D	S-U	1089	F-E	S-D	1157	F-E	S-D
1037	F-D	S-U	1090	F-E	S-D	1158	F-E	S-C
1038	<u>F-D</u>	S-U	1091	F-E	S-D	1159	F-E	S-D
1039	F-D	S-U	1092	F-E	S-D	1160	F-E	S-C
1040	F-D	S-U	1093	F-E	S-D	1161	F-E	S-D
1041	F-D	S-U	1098	F-E	S-D	1162	<u>F-E</u>	S-C
1043	F-C	S-V	1099	F-E	S-D	1163	F-E	S-C
1044	F-C	S-V	1100	F-E	S-D	1164	F-E	S-D
1045	F-C	S-W	1104	F-E	S-D	1165	F-E	S-D
1046	F-C	S-V	1105	F-E	S-D	1166	F-E	S-D
1048	F-C	S-U	1106	F-E	S-C	1167	F-E	S-D
1049	F-D	S-U	1107	F-E	S-D	1169	F-E	S-D
1050	F-C	S-U	1108	F-E	S-D	1170	F-E	S-D
1051	F-E	S-D	1109	F-E	S-D	1171	F-E	S-D
1052	F-C	S-U	1110	F-E	S-D	1172	F-E	S-D
1053	F-D	S-U	1111	F-E	S-D	1173	F-E	S-D
1055	F-D	S-U	1112	F-E	S-D	1175	F-E	S-D
1056	F-C	S-V	1113	F-E	S-D	1176	F-E	S-D
1057	F-D	S-U	1114	F-E	S-D	1177	F-E	S-D
1058	F-C	S-V	1120	F-E	S-D	1178	F-E	S-D
1060	F-D	S-U	1123	F-E	S-D	1179	F-E	S-D
1061	F-D	S-U	1125	F-E	S-C	1180	F-E	S-D
1062	F-C	S-U	1126	F-E	S-D	1181	F-E	S-D
1063	F-D	S-U	1127	F-E	S-D	1182	F-E	S-C
1064	F-D	S-U	1128	F-E	S-D	1183	F-G	S-O
1065	F-C	S-V	1129	F-E	S-D	1184	F-E	S-D
1066	F-C	S-V	1130	F-E	S-E	1185	F-E	S-D
1067	F-C	S-W	1131	F-E	S-D	1188	F-E	S-D
1069	F-C	S-U	1133	F-E	S-D	1189	F-E	S-D
1070	<u>F-C</u>	S-W	1134	F-E	S-D	1190	F-E	S-D

UN No.	EmS Fire	EmS Spill	UN No.	EmS Fire	EmS Spill	UN No.	EmS Fire	EmS Spill
1191	F-E	S-D	1250	<u>F-E</u>	S-C	1314	F-A	S-I
1192	F-E	S-D	1251	F-E	S-C	1318	F-A	S-I
1193	F-E	S-D	1259	F-E	S-D	1320	F-B	S-J
1194	F-E	S-D	1261	F-E	S-D	1321	F-B	S-J
1195	F-E	S-D	1262	F-E	S-E	1322	F-B	S-J
1196	F-E	S-C	1263	F-E	<u>S-E</u>	1323	F-G	S-G
1197	F-E	S-D	1264	F-E	S-D	1324	F-A	S-I
1198	F-E	S-C	1265	F-E	S-D	1325	F-A	S-G
1199	F-E	S-D	1266	F-E	S-D	1326	F-A	S-J
1201	F-E	S-D	1267	F-E	S-E	1327	F-A	S-I
1202	F-E	S-E	1268	F-E	S-E	1328	F-A	S-G
1203	F-E	S-E	1272	F-E	S-E	1330	F-A	S-I
1204	F-E	S-D	1274	F-E	S-D	1331	F-A	S-I
1206	F-E	S-D	1275	F-E	S-D	1332	F-A	S-G
1207	F-E	S-D	1276	F-E	S-D	1333	F-G	S-P
1208	F-E	S-D	1277	F-E	S-C	1334	F-A	S-G
1210	F-E	S-D	1278	F-E	S-D	1336	F-B	S-J
1212	F-E	S-D	1279	F-E	S-D	1337	F-B	S-J
1213	F-E	S-D	1280	F-E	S-D	1338	F-A	S-G
1214	F-E	S-C	1281	F-E	S-D	1339	F-G	S-G
1216	F-E	S-D	1282	F-E	S-D	1340	F-G	S-N
1218	F-E	S-D	1286	F-E	S-E	1341	F-A	S-G
1219	F-E	S-D	1287	F-E	S-D	1343	F-G	S-G
1220	F-E	S-D	1288	F-E	S-E	1344	F-B	S-J
1221	F-E	S-C	1289	F-E	S-C	1345	F-A	S-I
1222	F-E	S-D	1292	F-E	S-D	1346	F-A	S-G
1223	F-E	S-E	1293	F-E	S-D	1347	F-B	S-J
1224	F-E	S-D	1294	F-E	S-D	1348	F-B	S-J
1228	F-E	S-D	1295	F-G	<u>S-Q</u>	1349	F-B	S-J
1229	F-E	S-D	1296	F-E	S-C	1350	F-A	S-G
1230	F-E	S-D	1297	F-E	S-C	1352	F-A	S-J
1231	F-E	S-D	1298	<u>F-E</u>	S-C	1353	F-A	S-I
1233	F-E	S-D	1299	F-E	S-E	1354	F-B	S-J
1234	F-E	S-D	1300	F-E	S-E	1355	F-B	S-J
1235	F-E	S-C	1301	F-E	S-D	1356	F-B	S-J
1237	F-E	S-D	1302	F-E	S-D	1357	F-B	S-J
1238	F-E	S-C	1303	F-E	S-D	1358	F-G	S-J
1239	F-E	S-D	1304	F-E	S-D	1360	F-G	S-N
1242	F-G	S-O	1305	F-E	S-C	1361	F-A	S-J
1243	F-E	S-D	1306	F-E	S-D	1362	F-A	S-J
1244	F-E	S-C	1307	F-E	S-D	1363	F-A	S-J
1245	F-E	S-D	1308	F-E	S-D	1364	F-A	S-J
1246	F-E	S-D	1309	F-G	S-G	1365	F-A	S-J
1247	F-E	S-D	1310	F-B	S-J	1369	F-A	S-J
1248	F-E	S-D	1312	F-A	S-I	1372	F-A	S-J
1249	F-E	S-D	1313	F-A	S-I	1373	F-A	S-J

UN No.	EmS Fire	EmS Spill	UN No.	EmS Fire	EmS Spill	UN No.	EmS Fire	EmS Spill
1374	F-A	S-J	1423	F-G	S-N	1479	F-A	S-Q
1376	F-G	S-P	1426	F-G	S-O	1481	F-H	S-Q
1378	F-H	S-M	1427	F-G	S-O	1482	F-H	S-Q
1379	F-A	S-J	1428	F-G	S-N	1483	F-G	S-Q
1380	F-G	S-L	1431	F-A	S-L	1484	F-H	S-Q
1381	<u>F-A</u>	S-J	1432	F-G	S-N	1485	F-H	S-Q
1382	F-A	S-J	1433	F-G	S-N	1486	F-A	S-Q
1383	F-G	S-M	1435	F-G	S-O	1487	F-A	S-Q
1384	F-A	S-J	1436 I	<u>F-G</u>	S-O	1488	F-A	S-Q
1385	F-A	S-J	1436 II	F-G	S-O	1489	F-H	S-Q
1386	F-A	S-J	1436	F-G	S-O	1490	F-H	S-Q
1387	F-A	S-J	1437	F-A	S-G	1491	F-G	S-Q
1389	F-G	S-N	1438	F-A	S-Q	1492	F-A	S-Q
1390	F-G	S-O	1439	F-H	S-Q	1493	F-A	S-Q
1391	F-G	S-N	1442	F-H	S-Q	1494	F-H	S-Q
1392	F-G	S-N	1444	F-A	S-Q	1495	F-H	S-Q
1393	F-G	S-N	1445	F-H	S-Q	1496	F-H	S-Q
1394	F-G	S-N	1446	F-A	S-Q	1498	F-A	S-Q
1395	F-G	S-N	1447	F-H	S-Q	1499	F-A	S-Q
1396	F-G	S-O	1448	F-H	S-Q	1500	F-A	S-Q
1397	F-G	S-N	1449	F-G	S-Q	1502	F-H	S-Q
1398	F-G	S-N	1450	F-H	S-Q	1503	F-H	S-Q
1400	F-G	S-O	1451	F-A	S-Q	1504	F-G	S-Q
1401	F-G	S-O	1452	F-H	S-Q	1505	F-A	S-Q
1402 I	<u>F-G</u>	S-N	1453	F-H	S-Q	1506	F-H	S-Q
1402 II	F-G	S-N	1454	F-A	S-Q	1507	F-A	S-Q
1403	F-G	S-N	1455	F-H	S-Q	1508	F-H	S-Q
1404	F-G	S-O	1456	F-H	S-Q	1509	F-G	S-Q
1405	F-G	S-N	1457	F-G	S-Q	1510	F-H	S-Q
1407	F-G	S-N	1458	F-H	S-Q	1511	F-A	S-Q
1408	F-G	S-N	1459	F-H	S-Q	1513	F-H	S-Q
1409 I	<u>F-G</u>	S-L	1461	F-H	S-Q	1514	F-H	S-Q
1409 II	F-G	S-L	1462	F-H	S-Q	1515	F-H	S-Q
1410	F-G	S-M	1463	F-A	S-Q	1516	F-G	S-Q
1411	F-G	S-M	1465	F-A	S-Q	1517	F-B	S-J
1413	F-G	S-O	1466	F-A	S-Q	1541	F-A	S-A
1414	F-G	S-N	1467	F-A	S-Q	1544	F-A	S-A
1415	<u>F-G</u>	S-N	1469	F-A	S-Q	1545	F-E	S-D
1417	F-G	S-N	1470	F-H	S-Q	1546	F-A	S-A
1418 I	F-G	S-O	1471	F-H	S-Q	1547	F-A	S-A
1418 II	F-G	S-O	1472	F-G	S-Q	1548	F-A	S-A
1418 III	F-G	S-O	1473	F-H	S-Q	1549	F-A	S-A
1419	F-G	S-N	1474	F-A	S-Q	1550	F-A	S-A
1420	F-G	S-L	1475	F-H	S-Q	1551	F-A	S-A
1421	F-G	S-L	1476	F-G	S-Q	1553	F-A	S-A
1422	F-G	S-L	1477	F-A	S-Q	1554	F-A	S-A

UN No.	EmS Fire	EmS Spill	UN No.	EmS Fire	EmS Spill	UN No.	EmS Fire	EmS Spill
1555	F-A	S-A	1606	F-A	S-A	1660	F-C	S-W
1556	F-A	S-A	1607	F-A	S-A	1661	F-A	S-A
1557	F-A	S-A	1608	F-A	S-A	1662	F-A	S-A
1558	F-A	S-A	1611	F-A	S-A	1663	F-A	S-A
1559	F-A	S-A	1612	F-C	S-U	1664	F-A	S-A
1560	F-A	S-A	1613	F-A	S-A	1665	F-A	S-A
1561	F-A	S-A	1614	F-A	<u>S-U</u>	1669	F-A	S-A
1562	F-A	S-A	1616	F-A	S-A	1670	F-A	S-A
1564	F-A	S-A	1617	F-A	S-A	1671	F-A	S-A
1565	F-A	S-A	1618	F-A	S-A	1672	F-A	S-A
1566	F-A	S-A	1620	F-A	S-A	1673	F-A	S-A
1567	F-G	S-G	1621	F-A	S-A	1674	F-A	S-A
1569	F-E	S-D	1622	F-A	S-A	1677	F-A	S-A
1570	F-A	S-A	1623	F-A	S-A	1678	F-A	S-A
1571	F-B	S-J	1624	F-A	S-A	1679	F-A	S-A
1572	F-A	S-A	1625	F-A	S-A	1680	F-A	S-A
1573	F-A	S-A	1626	F-A	S-A	1683	F-A	S-A
1574	F-A	S-A	1627	F-A	S-A	1684	F-A	S-A
1575	F-A	S-A	1629	F-A	S-A	1685	F-A	S-A
1577	F-A	S-A	1630	F-A	S-A	1686	F-A	S-A
1578	F-A	S-A	1631	F-A	S-A	1687	F-A	S-A
1579	F-A	S-A	1634	F-A	S-A	1688	F-A	S-A
1580	F-A	S-A	1636	F-A	S-A	1689	F-A	S-A
1581	F-C	S-U	1637	F-A	S-A	1690	F-A	S-A
1582	F-C	S-U	1638	F-A	S-A	1691	F-A	S-A
1583	F-A	S-A	1639	F-A	S-A	1692	F-A	S-A
1585	F-A	S-A	1640	F-A	S-A	1693	F-A	S-A
1586	F-A	S-A	1641	F-A	S-A	1694	F-A	S-A
1587	F-A	S-A	1642	F-A	S-A	1695	F-E	S-C
1588	F-A	S-A	1643	F-A	S-A	1697	F-A	S-A
1589	F-C	S-U	1644	F-A	S-A	1698	F-A	S-A
1590	F-A	S-A	1645	F-A	S-A	1699	F-A	S-A
1591	F-A	S-A	1646	F-A	S-A	1700	F-A	S-G
1593	F-A	S-A	1647	F-A	S-A	1701	F-A	S-A
1594	F-A	S-A	1648	F-E	S-D	1702	F-A	S-A
1595	F-A	S-B	1649	F-A	S-A	1704	F-A	S-A
1596	F-A	S-A	1650	F-A	S-A	1707	F-A	S-A
1597	F-A	S-A	1651	F-A	S-A	1708	F-A	S-A
1598	F-A	S-A	1652	F-A	S-A	1709	F-A	S-A
1599	F-A	S-A	1653	F-A	S-A	1710	F-A	S-A
1600	F-A	S-A	1654	F-A	S-A	1711	F-A	S-A
1601	F-A	S-A	1655	F-A	S-A	1712	F-A	S-A
1602	F-A	S-A	1656	F-A	S-A	1713	F-A	S-A
1603	F-E	S-D	1657	F-A	S-A	1714	F-G	S-N
1604	F-E	S-C	1658	F-A	S-A	1715	F-E	S-C
1605	F-A	S-A	1659	F-A	S-A	1716	F-A	S-B

UN No.	EmS Fire	EmS Spill	UN No.	EmS Fire	EmS Spill	UN No.	EmS Fire	EmS Spill
1717	F-E	S-C	1767	F-E	S-C	1816	F-E	S-C
1718	F-A	S-B	1768	F-A	S-B	1817	F-A	S-B
1719	F-A	S-B	1769	F-A	S-B	1818	F-A	S-B
1722	F-E	S-C	1770	F-A	S-B	1819	F-A	S-B
1723	F-E	S-C	1771	F-A	S-B	1823	F-A	S-B
1724	F-E	S-C	1773	F-A	S-B	1824	F-A	S-B
1725	F-A	S-B	1774	F-A	S-B	1825	F-A	S-B
1726	F-A	S-B	1775	F-A	S-B	1826 II	F-A	S-B
1727	F-A	S-B	1776	F-A	S-B	1826 I	F-A	S-Q
1728	F-A	S-B	1777	F-A	S-B	1827	F-A	S-B
1729	F-A	S-B	1778	F-A	S-B	1828	F-A	S-B
1730	F-A	S-B	1779	F-E	S-C	1829	F-A	S-B
1731	F-A	S-B	1780	F-A	S-B	1830	F-A	S-B
1732	F-A	S-B	1781	F-A	S-B	1831	F-A	S-B
1733	F-A	S-B	1782	F-A	S-B	1832	F-A	S-B
1736	F-A	S-B	1783	F-A	S-B	1833	F-A	S-B
1737	F-A	S-B	1784	F-A	S-B	1834	F-A	S-B
1738	F-A	S-B	1786	F-A	S-B	1835	F-A	S-B
1739	F-A	S-B	1787	F-A	S-B	1836	F-A	S-B
1740	F-A	S-B	1788	F-A	S-B	1837	F-A	S-B
1741	F-C	S-U	1789	F-A	S-B	1838	F-A	S-B
1742	F-A	S-B	1790	F-A	S-B	1839	F-A	S-B
1743	F-A	S-B	1791	F-A	S-B	1840	F-A	S-B
1744	F-A	S-B	1792	F-A	S-B	1841	F-A	S-B
1745	F-A	S-B	1793	F-A	S-B	1843	F-A	S-A
1746	F-A	S-B	1794	F-A	S-B	1845	F-C	S-V
1747	F-E	S-C	1796 I	F-A	S-Q	1846	F-A	S-A
1748	F-H	S-Q	1796 II	F-A	S-B	1847	F-A	S-B
1749	F-C	S-W	1798	F-A	S-B	1848	F-A	S-B
1750	F-A	S-B	1799	F-A	S-B	1849	F-A	S-B
1751	F-A	S-B	1800	F-A	S-B	1851	F-A	S-A
1752	F-A	S-B	1801	F-A	S-B	1854	F-G	S-M
1753	F-A	S-B	1802	F-H	S-Q	1855	F-G	S-M
1754	F-A	S-B	1803	F-A	S-B	1856	F-A	S-J
1755	F-A	S-B	1804	F-A	S-B	1857	F-A	S-J
1756	F-A	S-B	1805	F-A	S-B	1858	F-C	S-V
1757	F-A	S-B	1806	F-A	S-B	1859	F-C	S-U
1758	F-A	S-B	1807	F-A	S-B	1860	F-D	S-U
1759	F-A	S-B	1808	F-A	S-B	1862	F-E	S-D
1760	F-A	S-B	1809	F-A	S-B	1863	F-E	S-E
1761	F-A	S-B	1810	F-A	S-B	1865	F-E	S-D
1762	F-A	S-B	1811	F-A	S-B	1866	F-E	S-E
1763	F-A	S-B	1812	F-A	S-A	1868	F-A	S-G
1764	F-A	S-B	1813	F-A	S-B	1869	F-G	S-G
1765	F-A	S-B	1814	F-A	S-B	1870	F-G	S-O
1766	F-A	S-B	1815	F-E	S-C	1871	F-A	S-G

UN No.	EmS Fire	EmS Spill	UN No.	EmS Fire	EmS Spill	UN No.	EmS Fire	EmS Spill
1872	F-A	S-Q	1945	F-A	S-I	2002	F-A	S-J
1873	F-A	S-Q	1950	F-D	S-U	2004	F-G	S-M
1884	F-A	S-A	1951	F-C	S-V	2006	F-A	S-G
1885	F-A	S-A	1952	F-C	S-V	2008	F-G	S-M
1886	F-A	S-A	1953	F-D	S-U	2009	F-G	S-M
1887	F-A	S-A	1954	F-D	S-U	2010	F-G	S-O
1888	F-A	S-A	1955	F-C	S-U	2011	F-G	S-N
1889	F-A	S-B	1956	F-C	S-V	2012	F-G	S-N
1891	F-A	S-A	1957	F-D	S-U	2013	F-G	S-N
1892	F-A	S-A	1958	F-C	S-V	2014	F-H	S-Q
1894	F-A	S-A	1959	F-D	S-U	2015	F-H	S-Q
1895	F-A	S-A	1961	F-D	S-U	2016	F-A	S-A
1897	F-A	S-A	1962	F-D	S-U	2017	F-A	S-B
1898	F-A	S-B	1963	F-C	S-V	2018	F-A	S-A
1902	F-A	S-B	1964	F-D	S-U	2019	F-A	S-A
1903	F-A	S-B	1965	<u>F-D</u>	S-U	2020	F-A	S-A
1905	F-A	S-B	1966	<u>F-D</u>	S-U	2021	F-A	S-A
1906	F-A	S-B	1967	F-C	S-U	2022	F-A	S-B
1907	F-A	S-B	1968	F-C	S-V	2023	F-E	S-D
1908	F-A	S-B	1969	F-D	S-U	2024	F-A	S-A
1911	F-D	S-U	1970	F-C	S-V	2025	F-A	S-A
1912	F-D	S-U	1971	F-D	S-U	2026	F-A	S-A
1913	F-C	S-V	1972	<u>F-D</u>	S-U	2027	F-A	S-A
1914	F-E	S-D	1973	F-C	S-V	2028	F-A	S-B
1915	F-E	S-D	1974	F-C	S-V	2029	F-E	<u>S-C</u>
1916	F-E	S-D	1975	F-C	S-W	2030	F-A	S-B
1917	F-E	S-D	1976	F-C	S-V	2031 I	F-A	S-Q
1918	F-E	S-E	1977	F-C	S-V	2031 II*	F-A	S-Q
1919	F-E	S-D	1978	F-D	S-U	2031 II†	F-A	S-B
1920	F-E	S-E	1982	F-C	S-V	2032	F-A	S-Q
1921	F-E	S-D	1983	F-C	S-V	2033	F-A	S-B
1922	F-E	S-C	1984	F-C	S-V	2034	F-D	S-U
1923	F-A	S-J	1986	F-E	S-D	2035	F-D	S-U
1928	F-G	S-L	1987	F-E	S-D	2036	F-C	S-V
1929	F-A	S-J	1988	F-E	S-D	2037	F-D	S-U
1931	F-A	S-J	1989	F-E	S-D	2038	F-A	S-A
1932	F-G	S-L	1990	F-A	S-A	2044	F-D	S-U
1935	F-A	S-A	1991	F-E	S-D	2045	F-E	S-D
1938	F-A	S-B	1992	F-E	S-D	2046	F-E	S-D
1939	F-A	S-B	1993	F-E	<u>S-E</u>	2047	F-E	S-D
1940	F-A	S-B	1994	F-E	S-D	2048	F-E	S-D
1941	F-A	S-A	1999	F-E	S-E	2049	F-E	S-D
1942	F-H	S-Q	2000	F-A	S-I	2050	F-E	S-D
1944	F-A	S-I	2001	F-A	S-I	2051	F-E	S-C

* Applies to NITRIC ACID other than red fuming, with at least 65% but with not more than 70% nitric acid.

† Applies to NITRIC ACID other than red fuming, with less than 65% nitric acid.

UN No.	EmS Fire	EmS Spill	UN No.	EmS Fire	EmS Spill	UN No.	EmS Fire	EmS Spill
2052	F-E	S-E	2217	F-A	S-J	2272	F-A	S-A
2053	F-E	S-D	2218	F-E	S-C	2273	F-A	S-A
2054	F-E	S-C	2219	F-E	S-D	2274	F-A	S-A
2055	F-E	S-D	2222	F-E	S-D	2275	F-E	S-D
2056	F-E	S-D	2224	F-A	S-A	2276	F-E	S-C
2057	F-E	S-D	2225	F-A	S-B	2277	F-E	S-D
2058	F-E	S-D	2226	F-A	S-B	2278	F-E	S-D
2059	F-E	S-D	2227	F-E	S-D	2279	F-A	S-A
2067	F-H	S-Q	2232	F-A	S-A	2280	F-A	S-B
2071	F-H	S-Q	2233	F-A	S-A	2281	F-A	S-A
2073	F-C	S-U	2234	F-E	S-D	2282	F-E	S-D
2074	F-A	S-A	2235	F-A	S-A	2283	F-E	S-D
2075	F-A	S-A	2236	F-A	S-A	2284	F-E	S-D
2076	F-A	S-B	2237	F-A	S-A	2285	F-E	S-D
2077	F-A	S-A	2238	F-E	S-D	2286	F-E	S-D
2078	F-A	S-A	2239	F-A	S-A	2287	F-E	S-D
2079	F-A	S-B	2240	F-A	S-B	2288	F-E	S-D
2187	F-C	S-V	2241	F-E	S-D	2289	F-A	S-B
2188	F-D	S-U	2242	F-E	S-D	2290	F-A	S-A
2189	F-D	S-U	2243	F-E	S-D	2291	F-A	S-A
2190	F-C	S-W	2244	F-E	S-D	2293	F-E	S-D
2191	F-C	S-U	2245	F-E	S-D	2294	F-A	S-A
2192	F-D	S-U	2246	F-E	S-D	2295	F-E	S-D
2193	F-C	S-V	2247	F-E	S-E	2296	F-E	S-D
2194	F-C	S-U	2248	F-E	S-C	2297	F-E	S-D
2195	F-C	S-U	2249	F-E	S-D	2298	F-E	S-D
2196	F-C	S-U	2250	F-A	S-A	2299	F-A	S-A
2197	F-C	S-U	2251	F-E	S-D	2300	F-A	S-A
2198	F-C	S-U	2252	F-E	S-D	2301	F-E	S-D
2199	F-D	S-U	2253	F-A	S-A	2302	F-E	S-D
2200	F-D	S-U	2254	F-A	S-I	2303	F-E	S-D
2201	F-C	S-W	2256	F-E	S-D	2304	F-A	S-H
2202	F-D	S-U	2257	F-G	S-N	2305	F-A	S-B
2203	F-D	S-U	2258	F-E	S-C	2306	F-A	S-A
2204	F-D	S-U	2259	F-A	S-B	2307	F-A	S-A
2205	F-A	S-A	2260	F-E	S-C	2308	F-A	S-B
2206	F-A	S-A	2261	F-A	S-A	2309	F-E	S-D
2208	F-H	S-Q	2262	F-A	S-B	2310	F-E	S-D
2209	F-A	S-B	2263	F-E	S-D	2311	F-A	S-A
2210	F-G	S-L	2264	F-E	S-C	2312	F-A	S-A
2211	F-A	S-I	2265	F-E	S-D	2313	F-E	S-D
2212	F-A	S-A	2266	F-E	S-C	2315	F-A	S-A
2213	F-A	S-G	2267	F-A	S-B	2316	F-A	S-A
2214	F-A	S-B	2269	F-A	S-B	2317	F-A	S-A
2215	F-A	S-B	2270	F-E	S-C	2318	F-A	S-J
2216	F-A	S-J	2271	F-E	S-D	2319	F-E	S-D

UN No.	EmS Fire	EmS Spill	UN No.	EmS Fire	EmS Spill	UN No.	EmS Fire	EmS Spill
2320	F-A	S-B	2370	F-E	S-D	2418	F-C	S-U
2321	F-A	S-A	2371	F-E	S-D	2419	F-D	S-U
2322	F-A	S-A	2372	F-E	S-D	2420	F-C	S-U
2323	F-E	S-D	2373	F-E	S-D	2421	F-C	S-W
2324	F-E	S-D	2374	F-E	S-D	2422	F-C	S-V
2325	F-E	S-D	2375	F-E	S-D	2424	F-C	S-V
2326	F-A	S-B	2376	F-E	S-D	2426	F-H	S-Q
2327	F-A	S-B	2377	F-E	S-D	2427	F-H	S-Q
2328	F-A	S-A	2378	F-E	S-D	2428	F-H	S-Q
2329	F-E	S-D	2379	F-E	S-C	2429	F-H	S-Q
2330	F-E	S-E	2380	F-E	S-D	2430	F-A	S-B
2331	F-A	S-B	2381	F-E	S-D	2431	F-A	S-A
2332	F-E	S-D	2382	F-E	S-D	2432	F-A	S-A
2333	F-E	S-D	2383	F-E	S-C	2433	F-A	S-A
2334	F-E	S-D	2384	F-E	S-D	2434	F-A	S-B
2335	F-E	S-D	2385	F-E	S-D	2435	F-A	S-B
2336	F-E	S-D	2386	F-E	S-C	2436	F-E	S-D
2337	F-E	S-D	2387	F-E	S-D	2437	F-A	S-B
2338	F-E	S-D	2388	F-E	S-D	2438	F-E	S-C
2339	F-E	S-D	2389	F-E	S-D	2439	F-A	S-B
2340	F-E	S-D	2390	F-E	S-D	2440	F-A	S-B
2341	F-E	S-D	2391	F-E	S-D	2441	F-G	S-M
2342	F-E	S-D	2392	F-E	S-D	2442	F-A	S-B
2343	F-E	S-D	2393	F-E	S-D	2443	F-A	S-B
2344	F-E	S-D	2394	F-E	S-D	2444	F-A	S-B
2345	F-E	S-D	2395	F-E	S-C	2446	F-A	S-A
2346	F-E	S-D	2396	F-E	S-D	2447	F-A	S-M
2347	F-E	S-D	2397	F-E	S-D	2448	F-A	S-H
2348	F-E	S-D	2398	F-E	S-D	2451	F-C	S-W
2350	F-E	S-D	2399	F-E	S-C	2452	F-D	S-U
2351	F-E	S-D	2400	F-E	S-D	2453	F-D	S-U
2352	F-E	S-D	2401	F-E	S-C	2454	F-D	S-U
2353	F-E	S-C	2402	F-E	S-D	2456	F-E	S-D
2354	F-E	S-D	2403	F-E	S-D	2457	F-E	S-D
2356	F-E	S-D	2404	F-E	S-D	2458	F-E	S-D
2357	F-E	S-C	2405	F-E	S-D	2459	F-E	S-D
2358	F-E	S-D	2406	F-E	S-D	2460	F-E	S-D
2359	F-E	S-C	2407	F-E	S-C	2461	F-E	S-D
2360	F-E	S-D	2409	F-E	S-D	2463	F-G	S-O
2361	F-E	S-C	2410	F-E	S-D	2464	F-A	S-Q
2362	F-E	S-D	2411	F-E	S-D	2465	F-A	S-Q
2363	F-E	S-D	2412	F-E	S-D	2466	F-G	S-Q
2364	F-E	S-D	2413	F-E	S-D	2468	F-A	S-Q
2366	F-E	S-D	2414	F-E	S-D	2469	F-H	S-Q
2367	F-E	S-D	2416	F-E	S-D	2470	F-A	S-A
2368	F-E	S-E	2417	F-C	S-U	2471	F-A	S-A

UN No.	EmS Fire	EmS Spill	UN No.	EmS Fire	EmS Spill	UN No.	EmS Fire	EmS Spill
2473	F-A	S-A	2531	F-A	S-B	2602	F-C	S-V
2474	F-A	S-A	2533	F-A	S-A	2603	F-E	S-D
2475	F-A	S-B	2534	F-D	S-U	2604	F-E	S-C
2477	F-E	S-D	2535	F-E	S-C	2605	F-E	S-D
2478	F-E	S-D	2536	F-E	S-D	2606	F-E	S-D
2480	F-E	S-D	2538	F-A	S-G	2607	F-E	S-D
2481	F-E	S-D	2541	F-E	S-E	2608	F-E	S-D
2482	F-E	S-D	2542	F-A	S-A	2609	F-A	S-A
2483	F-E	S-D	2545	F-G	S-M	2610	F-E	S-C
2484	F-E	S-D	2546	F-G	S-M	2611	F-E	S-D
2485	F-E	S-D	2547	F-G	S-Q	2612	F-E	S-D
2486	F-E	S-D	2548	F-C	S-W	2614	F-E	S-D
2487	F-E	S-D	2552	F-A	S-A	2615	F-E	S-D
2488	F-E	S-D	2554	F-E	S-D	2616	F-E	S-D
2490	F-A	S-A	2555	F-B	S-J	2617	F-E	S-D
2491	F-A	S-B	2556	F-B	S-J	2618	F-E	S-D
2493	F-E	S-C	2557	F-B	S-J	2619	F-E	S-C
2495	F-A	S-Q	2558	F-E	S-D	2620	F-E	S-D
2496	F-A	S-B	2560	F-E	S-D	2621	F-E	S-D
2498	F-E	S-D	2561	F-E	S-D	2622	F-E	S-D
2501	F-A	S-A	2564	F-A	S-B	2623	F-A	S-I
2502	F-E	S-C	2565	F-A	S-B	2624	F-G	S-O
2503	F-A	S-B	2567	F-A	S-A	2626	F-A	S-Q
2504	F-A	S-A	2570	F-A	S-A	2627	F-A	S-Q
2505	F-A	S-A	2571	F-A	S-B	2628	F-A	S-A
2506	F-A	S-B	2572	F-A	S-A	2629	F-A	S-A
2507	F-A	S-B	2573	F-H	S-Q	2630	F-A	S-A
2508	F-A	S-B	2574	F-A	S-A	2642	F-A	S-A
2509	F-A	S-B	2576	F-A	S-B	2643	F-A	S-A
2511	F-A	S-B	2577	F-A	S-B	2644	F-A	S-A
2512	F-A	S-A	2578	F-A	S-B	2645	F-A	S-A
2513	F-A	S-B	2579	F-A	S-B	2646	F-A	S-A
2514	F-E	S-D	2580	F-A	S-B	2647	F-A	S-A
2515	F-A	S-A	2581	F-A	S-B	2648	F-A	S-A
2516	F-A	S-A	2582	F-A	S-B	2649	F-A	S-A
2517	F-D	S-U	2583	F-A	S-B	2650	F-A	S-A
2518	F-A	S-A	2584	F-A	S-B	2651	F-A	S-A
2520	F-E	S-D	2585	F-A	S-B	2653	F-A	S-A
2521	F-E	S-D	2586	F-A	S-B	2655	F-A	S-A
2522	F-A	S-A	2587	F-A	S-A	2656	F-A	S-A
2524	F-E	S-D	2588	F-A	S-A	2657	F-A	S-A
2525	F-A	S-A	2589	F-E	S-D	2659	F-A	S-A
2526	F-E	S-C	2590	F-A	S-A	2660	F-A	S-A
2527	F-E	S-D	2591	F-C	S-V	2661	F-A	S-A
2528	F-E	S-D	2599	F-C	S-V	2664	F-A	S-A
2529	F-E	S-C	2601	F-D	S-U	2667	F-A	S-A

UN No.	EmS Fire	EmS Spill	UN No.	EmS Fire	EmS Spill	UN No.	EmS Fire	EmS Spill
2668	F-A	S-A	2729	F-A	S-A	2788	F-A	S-A
2669	F-A	S-A	2730	F-A	S-A	2789	F-E	S-C
2670	F-A	S-B	2732	F-A	S-A	2790	F-A	S-B
2671	F-A	S-A	2733	F-E	S-C	2793	F-G	S-J
2672	F-A	S-B	2734	F-E	S-C	2794	F-A	S-B
2673	F-A	S-A	2735	F-A	S-B	2795	F-A	S-B
2674	F-A	S-A	2738	F-A	S-A	2796	F-A	S-B
2676	F-D	S-U	2739	F-A	S-B	2797	F-A	S-B
2677	F-A	S-B	2740	F-E	S-C	2798	F-A	S-B
2678	F-A	S-B	2741	F-H	S-Q	2799	F-A	S-B
2679	F-A	S-B	2742	F-E	S-C	2800	F-A	S-B
2680	F-A	S-B	2743	F-E	S-C	2801	F-A	S-B
2681	F-A	S-B	2744	F-E	S-C	2802	F-A	<u>S-B</u>
2682	F-A	S-B	2745	F-A	S-B	2803	F-A	S-B
2683	F-E	S-C	2746	F-A	S-B	2805	F-G	S-N
2684	F-E	S-C	2747	F-A	S-A	2806	F-A	S-O
2685	F-E	S-C	2748	F-A	S-B	2809	F-A	<u>S-B</u>
2686	F-E	S-C	2749	F-E	<u>S-D</u>	2810	F-A	S-A
2687	F-A	S-G	2750	F-A	S-A	2811	F-A	S-A
2688	F-A	S-A	2751	F-A	S-B	2813 I	<u>F-G</u>	S-N
2689	F-A	S-A	2752	F-E	S-D	2813 II	F-G	S-N
2690	F-A	S-A	2753	F-A	S-A	2813 III	F-G	S-N
2691	F-A	S-B	2754	F-A	S-A	2814	F-A	S-T
2692	F-A	S-B	2757	F-A	S-A	2815	F-A	S-B
2693	F-A	S-B	2758	F-E	S-D	2817	F-A	S-B
2698	F-A	S-B	2759	F-A	S-A	2818	F-A	S-B
2699	F-A	S-B	2760	F-E	S-D	2819	F-A	S-B
2705	F-A	S-B	2761	F-A	S-A	2820	F-A	S-B
2707	F-E	S-D	2762	F-E	S-D	2821	F-A	S-A
2709	F-E	S-D	2763	F-A	S-A	2822	F-A	S-A
2710	F-E	S-D	2764	F-E	S-D	2823	F-A	S-B
2713	F-A	S-A	2771	F-A	S-A	2826	F-E	S-C
2714	F-A	S-I	2772	F-E	S-D	2829	F-A	S-B
2715	F-A	S-I	2775	F-A	S-A	2830	F-G	S-N
2716	F-A	S-A	2776	F-E	S-D	2831	F-A	S-A
2717	F-A	S-I	2777	F-A	S-A	2834	F-A	S-B
2719	F-H	S-Q	2778	F-E	S-D	2835	F-G	S-O
2720	F-A	S-Q	2779	F-A	S-A	2837	F-A	S-B
2721	F-H	S-Q	2780	F-E	S-D	2838	F-E	S-D
2722	F-A	S-Q	2781	F-A	S-A	2839	F-A	S-A
2723	F-H	S-Q	2782	F-E	S-D	2840	F-E	S-D
2724	F-A	S-Q	2783	F-A	S-A	2841	F-E	S-D
2725	F-A	S-Q	2784	F-E	S-D	2842	F-E	S-D
2726	F-A	S-Q	2785	F-A	S-A	2844	F-G	S-N
2727	F-A	S-Q	2786	F-A	S-A	2845	F-G	S-M
2728	F-A	S-Q	2787	F-E	S-D	2846	F-G	S-M

UN No.	EmS Fire	EmS Spill	UN No.	EmS Fire	EmS Spill	UN No.	EmS Fire	EmS Spill
2849	F-A	S-A	2921	F-A	S-G	2995	F-E	S-D
2850	F-E	S-E	2922	F-A	S-B	2996	F-A	S-A
2851	F-A	S-B	2923	F-A	S-B	2997	F-E	S-D
2852	F-B	S-J	2924	F-E	S-C	2998	F-A	S-A
2853	F-A	S-A	2925	F-A	S-G	3005	F-E	S-D
2854	F-A	S-A	2926	F-A	S-G	3006	F-A	S-A
2855	F-A	S-A	2927	F-A	S-B	3009	F-E	S-D
2856	F-A	S-A	2928	F-A	S-B	3010	F-A	S-A
2857	F-C	S-V	2929	F-E	S-D	3011	F-E	S-D
2858	F-G	S-G	2930	F-A	S-G	3012	F-A	S-A
2859	F-A	S-A	2931	F-A	S-A	3013	F-E	S-D
2861	F-A	S-A	2933	F-E	S-D	3014	F-A	S-A
2862	F-A	S-A	2934	F-E	S-D	3015	F-E	S-D
2863	F-A	S-A	2935	F-E	S-D	3016	F-A	S-A
2864	F-A	S-A	2936	F-A	S-A	3017	F-E	S-D
2865	F-A	S-B	2937	F-A	S-A	3018	F-A	S-A
2869	F-A	S-B	2940	F-A	S-J	3019	F-E	S-D
2870	F-G	S-M	2941	F-A	S-A	3020	F-A	S-A
2871	F-A	S-A	2942	F-A	S-A	3021	F-E	S-D
2872	F-A	S-A	2943	F-E	S-D	3022	F-E	S-D
2873	F-A	S-A	2945	F-E	S-C	3023	F-E	S-D
2874	F-A	S-A	2946	F-A	S-A	3024	F-E	S-D
2875	F-A	S-A	2947	F-E	S-D	3025	F-E	S-D
2876	F-A	S-A	2948	F-A	S-A	3026	F-A	S-A
2878	F-G	S-G	2949	F-A	S-B	3027	F-A	S-A
2879	F-A	S-B	2950	F-G	S-O	3028	F-A	S-B
2880	F-H	S-Q	2956	F-B	S-G	3048	F-A	S-A
2881	F-G	S-M	2965	F-G	S-O	3054	F-E	S-D
2900	F-A	S-T	2966	F-A	S-A	3055	F-A	S-B
2901	F-C	S-W	2967	F-A	S-B	3056	F-E	S-D
2902	F-A	S-A	2968	F-G	<u>S-L</u>	3057	F-C	S-U
2903	F-E	S-D	2969	F-A	S-A	3064	F-E	S-D
2904	F-A	S-B	2977	<u>F-I</u>	<u>S-S</u>	3065	F-E	S-D
2905	F-A	S-B	2978	<u>F-I</u>	<u>S-S</u>	3066	F-A	S-B
2907	F-A	S-J	2983	F-E	S-D	3070	F-C	S-V
2908	F-I	S-S	2984	F-H	S-Q	3071	F-E	S-D
2909	F-I	S-S	2985	<u>F-E</u>	S-C	3072	F-A	<u>S-V</u>
2910	F-I	S-S	2986	F-E	S-C	3073	F-E	S-C
2911	F-I	S-S	2987	F-A	S-B	3077	F-A	S-F
2912	F-I	S-S	2988	F-G	S-N	3078	F-G	S-O
2913	F-I	S-S	2989	F-A	S-G	3079	F-E	S-D
2915	F-I	S-S	2990	F-A	S-V	3080	F-E	S-D
2916	F-I	S-S	2991	F-E	S-D	3082	F-A	S-F
2917	F-I	S-S	2992	F-A	S-A	3083	F-C	S-W
2919	F-I	<u>S-S</u>	2993	F-E	S-D	3084	F-A	S-Q
2920	F-E	S-C	2994	F-A	S-A	3085	F-A	S-Q

UN No.	EmS Fire	EmS Spill	UN No.	EmS Fire	EmS Spill	UN No.	EmS Fire	EmS Spill
3086	F-A	S-Q	3130 I	<u>F-G</u>	S-N	3165	F-E	S-C
3087	F-A	S-Q	3130 II	F-G	S-N	3166 (for gases)	F-D	S-U
3088	F-A	S-J	3131 I	<u>F-G</u>	S-L	3166 (for liquids)	F-E	S-E
3089	F-G	S-G	3131 II	F-G	S-L	3167	F-D	S-U
3090	F-A	S-I	3131 III	F-G	S-L	3168	F-D	S-U
3091	F-A	S-I	3132 I	<u>F-G</u>	S-N	3169	F-C	S-U
3092	F-E	S-D	3132 II	F-G	S-N	3170	F-G	S-P
3093	F-A	S-Q	3132 III	F-G	S-N	3171	F-A	S-I
3094	F-G	S-L	3133	F-G	S-L	3172	F-A	S-A
3095	F-A	S-N	3134 I	<u>F-G</u>	S-N	3174	F-A	S-J
3096	F-G	S-L	3134 II	F-G	S-N	3175	F-A	S-I
3097	F-A	S-Q	3134 III	F-G	S-N	3176	F-A	S-H
3098	F-A	S-Q	3135 I	<u>F-G</u>	S-N	3178	F-A	S-G
3099	F-A	S-Q	3135 II	F-G	S-N	3179	F-A	S-G
3100	F-A	S-Q	3135 III	F-G	S-N	3180	F-A	S-G
3101	F-J	S-R	3136	F-C	S-V	3181	F-A	S-I
3102	F-J	S-R	3137	F-G	S-Q	3182	F-A	S-G
3103	F-J	S-R	3138	<u>F-D</u>	S-U	3183	F-A	S-J
3104	F-J	S-R	3139	F-A	S-Q	3184	F-A	S-J
3105	F-J	S-R	3140	F-A	S-A	3185	F-A	S-J
3106	F-J	S-R	3141	F-A	S-A	3186	F-A	S-J
3107	F-J	S-R	3142	F-A	S-A	3187	F-A	S-J
3108	F-J	S-R	3143	F-A	S-A	3188	F-A	S-J
3109	F-J	S-R	3144	F-A	S-A	3189	F-G	S-J
3110	F-J	S-R	3145	F-A	S-B	3190	F-A	S-J
3111	F-F	S-R	3146	F-A	S-A	3191	F-A	S-J
3112	F-F	S-R	3147	F-A	S-B	3192	F-A	S-J
3113	F-F	S-R	3148 I	<u>F-G</u>	S-N	3194	F-G	S-M
3114	F-F	S-R	3148 II	F-G	S-N	3200	F-G	S-M
3115	F-F	S-R	3148 III	F-G	S-N	3205	F-A	S-J
3116	F-F	S-R	3149	F-H	S-Q	3206	F-A	S-J
3117	F-F	S-R	3150	F-D	S-U	3208 I	<u>F-G</u>	S-N
3118	F-F	S-R	3151	F-A	S-A	3208 II	F-G	S-N
3119	F-F	S-R	3152	F-A	S-A	3208 III	F-G	S-N
3120	F-F	S-R	3153	F-D	S-U	3209 I	<u>F-G</u>	S-N
3121	F-G	S-L	3154	F-D	S-U	3209 II	F-G	S-N
3122	F-A	S-Q	3155	F-A	S-A	3209 III	F-G	S-N
3123	F-G	S-N	3156	<u>F-C</u>	S-W	3210	F-H	S-Q
3124	F-A	S-J	3157	<u>F-C</u>	S-W	3211	F-H	S-Q
3125	F-G	S-N	3158	F-C	S-V	3212	F-H	S-Q
3126	F-A	S-J	3159	F-C	S-V	3213	F-H	S-Q
3127	F-A	S-J	3160	<u>F-D</u>	S-U	3214	F-H	S-Q
3128	F-A	S-J	3161	F-D	S-U	3215	F-A	S-Q
3129 I	<u>F-G</u>	S-N	3162	F-C	S-U	3216	F-A	S-Q
3129 II	F-G	S-N	3163	F-C	S-V			
3129 III	F-G	S-N	3164	F-C	S-V			

UN No.	EmS Fire	EmS Spill	UN No.	EmS Fire	EmS Spill	UN No.	EmS Fire	EmS Spill
3218	F-A	S-Q	3264	F-A	S-B	3310	F-C	S-W
3219	F-A	S-Q	3265	F-A	S-B	3311	F-C	S-W
3220	F-C	S-V	3266	F-A	S-B	3312	<u>F-D</u>	S-U
3221	F-J	S-G	3267	F-A	S-B	3313	F-A	S-J
3222	F-J	S-G	3268	<u>F-B</u>	S-X	3314	F-A	S-I
3223	F-J	S-G	3269	F-E	S-D	3315	F-A	S-A
3224	F-J	S-G	3270	F-A	S-I	3316	F-A	<u>S-P</u>
3225	F-J	S-G	3271	F-E	S-D	3317	F-B	S-J
3226	F-J	S-G	3272	F-E	S-D	3318	F-C	S-U
3227	F-J	S-G	3273	F-E	S-D	3319	F-B	S-J
3228	F-J	S-G	3274	F-E	S-C	3320	F-A	S-B
3229	F-J	S-G	3275	F-E	S-D	3321	F-I	S-S
3230	F-J	S-G	3276	F-A	S-A	3322	F-I	S-S
3231	F-F	S-K	3277	F-A	S-B	3323	F-I	S-S
3232	F-F	S-K	3278	F-A	S-A	3324	F-I	<u>S-S</u>
3233	F-F	S-K	3279	F-E	S-D	3325	F-I	<u>S-S</u>
3234	F-F	S-K	3280	F-A	S-A	3326	F-I	<u>S-S</u>
3235	F-F	S-K	3281	F-A	S-A	3327	F-I	<u>S-S</u>
3236	F-F	S-K	3282	F-A	S-A	3328	F-I	<u>S-S</u>
3237	F-F	S-K	3283	F-A	S-A	3329	F-I	<u>S-S</u>
3238	F-F	S-K	3284	F-A	S-A	3330	F-I	<u>S-S</u>
3239	F-F	S-K	3285	F-A	S-A	3331	F-I	<u>S-S</u>
3240	F-F	S-K	3286	F-E	S-C	3332	<u>F-I</u>	<u>S-S</u>
3241	F-J	S-G	3287	F-A	S-A	3333	<u>F-I</u>	<u>S-S</u>
3242	F-J	S-G	3288	F-A	S-A	3336	F-E	S-D
3243	F-A	S-A	3289	F-A	S-B	3337	F-C	S-V
3244	F-A	S-B	3290	F-A	S-B	3338	F-C	S-V
3245	F-A	S-T	3291	F-A	S-T	3339	F-C	S-V
3246	F-A	S-B	3292	F-G	S-P	3340	F-C	S-V
3247	F-A	S-Q	3293	F-A	S-A	3341	F-A	S-J
3248	F-E	S-D	3294	F-E	S-D	3342	F-A	S-J
3249	F-A	S-A	3295	F-E	S-D	3343	F-E	S-Y
3250	F-A	S-B	3296	F-C	S-V	3344	F-B	S-J
3251	F-F	S-G	3297	F-C	S-V	3345	F-A	S-A
3252	F-D	S-U	3298	F-C	S-V	3346	F-E	S-D
3253	F-A	S-B	3299	F-C	S-V	3347	F-E	S-D
3254	F-A	S-M	3300	F-D	S-U	3348	F-A	S-A
3255	F-A	S-M	3301	F-A	S-J	3349	F-A	S-A
3256	F-E	S-D	3302	F-A	S-A	3350	F-E	S-D
3257	F-A	<u>S-P</u>	3303	F-C	S-W	3351	F-E	S-D
3258	F-A	<u>S-P</u>	3304	F-C	S-U	3352	F-A	S-A
3259	F-A	S-B	3305	F-D	S-U	3354	F-D	S-U
3260	F-A	S-B	3306	F-C	S-W	3355	F-D	S-U
3261	F-A	S-B	3307	F-C	S-W	3356	F-H	S-Q
3262	F-A	S-B	3308	F-C	S-U	3357	F-E	S-Y
3263	F-A	S-B	3309	<u>F-D</u>	S-U	3358	F-D	S-U

UN No.	EmS Fire	EmS Spill	UN No.	EmS Fire	EmS Spill	UN No.	EmS Fire	EmS Spill
3359	F-A	<u>S-D</u>	3399 II	F-G	S-N	3448	F-A	S-A
3360	F-A	S-I	3399 III	F-G	S-N	3449	F-A	S-A
3361	F-A	S-B	3400	F-A	S-J	3450	F-A	S-A
3362	F-E	S-C	3401	F-G	S-N	3451	F-A	S-A
3363	F-A	<u>S-P</u>	3402	F-G	S-N	3452	F-A	S-A
3364	F-B	S-J	3403	F-G	S-L	3453	F-A	S-B
3365	F-B	S-J	3404	F-G	S-L	3454	F-A	S-A
3366	F-B	S-J	3405	F-H	S-Q	3455	F-A	S-B
3367	F-B	S-J	3406	F-H	S-Q	3456	F-A	S-B
3368	F-B	S-J	3407	F-H	S-Q	3457	F-A	S-A
3369	F-B	S-J	3408	F-H	S-Q	3458	F-A	S-A
3370	F-B	S-J	3409	F-A	S-A	3459	F-A	S-A
3371	F-E	S-D	3410	F-A	S-A	3460	F-A	S-A
3373	F-A	S-T	3411	F-A	S-A	3462	F-A	S-A
3374	<u>F-D</u>	<u>S-U</u>	3412	F-A	S-B	3463	F-E	S-C
3375	F-H	S-Q	3413	F-A	S-A	3464	F-A	S-A
3376	F-B	S-J	3414	F-A	S-A	3465	F-A	S-A
3377	F-A	S-Q	3415	F-A	S-A	3466	F-A	S-A
3378	F-A	S-Q	3416	F-A	S-A	3467	F-A	S-A
3379	F-E	S-Y	3417	F-A	S-G	3468	F-D	S-U
3380	F-B	S-J	3418	F-A	S-A	3469	F-E	S-C
3381	F-A	S-A	3419	F-A	S-B	3470	F-E	S-C
3382	F-A	S-A	3420	F-A	S-B	3471	F-A	S-B
3383	F-E	S-D	3421	F-A	S-B	3472	F-A	S-B
3384	F-E	S-D	3422	F-A	S-A	3473	F-E	S-D
3385	F-G	S-N	3423	F-A	S-B	3474	F-B	S-J
3386	F-G	S-N	3424	F-A	S-A	3475	F-E	S-E
3387	F-A	S-Q	3425	F-A	S-B	3476	F-G	S-P
3388	F-A	S-Q	3426	F-A	S-A	3477	F-A	S-B
3389	F-A	S-B	3427	F-A	S-A	3478	F-D	S-U
3390	F-A	S-B	3428	F-A	S-A	3479	F-D	S-U
3391	F-G	S-M	3429	F-A	S-A	3480	F-A	S-I
3392	F-G	S-M	3430	F-A	S-A	3481	F-A	S-I
3393	F-G	S-M	3431	F-A	S-A	3482	F-G	S-N
3394	F-G	S-M	3432	F-A	S-A	3483	F-E	S-D
3395 I	<u>F-G</u>	S-N	3434	F-A	S-A	3484	F-E	<u>S-C</u>
3395 II	F-G	S-N	3436	F-A	S-A	3485	F-H	S-Q
3395 III	F-G	S-N	3437	F-A	S-A	3486	F-H	S-Q
3396 I	<u>F-G</u>	S-N	3438	F-A	S-A	3487	F-H	S-Q
3396 II	F-G	S-N	3439	F-A	S-A	3488	F-E	S-D
3396 III	F-G	S-N	3440	F-A	S-A	3489	F-E	S-D
3397 I	<u>F-G</u>	S-N	3441	F-A	S-A	3490	F-G	S-N
3397 II	F-G	S-N	3442	F-A	S-A	3491	F-G	S-N
3397 III	F-G	S-N	3443	F-A	S-A	3494	F-E	S-E
3398 I	<u>F-G</u>	S-N	3444	F-A	S-A	3495	F-A	S-B
3398 II	F-G	S-N	3445	F-A	S-A	3496	F-A	S-I
3398 III	F-G	S-N	3446	F-A	S-A	3497	F-A	S-J
3399 I	<u>F-G</u>	S-N	3447	F-A	S-A	3498	F-A	S-B

UN No.	EmS Fire	EmS Spill	UN No.	EmS Fire	EmS Spill	UN No.	EmS Fire	EmS Spill
3499	F-A	S-I	3517	F-D	S-U	3534	F-F	S-K
3500	F-C	S-V	3518	<u>F-C</u>	S-W	3535	F-A	S-G
3501	<u>F-D</u>	<u>S-U</u>	3519	F-C	S-U	3535	F-A	S-G
3502	F-C	<u>S-V</u>	3520	F-C	S-W	3536	F-A	S-I
3503	F-C	<u>S-V</u>	3521	F-C	S-U	3537	F-D	S-U
3504	<u>F-D</u>	<u>S-U</u>	3522	F-D	S-U	3538	F-C	S-V
3505	<u>F-D</u>	<u>S-U</u>	3523	F-D	S-U	3539	F-C	S-U
3506	F-A	<u>S-B</u>	3524	F-C	S-U	3540	F-E	<u>S-D</u>
3507	<u>F-I</u>	<u>S-S</u>	3525	F-D	S-U	3541	F-A	<u>S-G</u>
3508	F-A	S-I	3526	F-D	S-U	3542	*	*
3510	F-D	S-U	3527	F-A	S-G	3543	F-G	<u>S-N</u>
3511	F-C	S-V	3528	F-E	S-E	3544	F-A	<u>S-Q</u>
3512	F-C	S-U	3529	F-D	S-U	3545	F-J	<u>S-R</u>
3513	<u>F-C</u>	S-W	3530	F-A	S-F	3546	F-A	<u>S-A</u>
3514	F-D	S-U	3531	F-J	S-G	3547	F-A	<u>S-B</u>
3515	<u>F-C</u>	S-W	3532	F-J	S-G	3548	F-A	<u>S-P</u>
3516	F-C	S-U	3533	F-F	S-K			

* F-G, S-M for pyrophoric substances, F-A, S-J for self-heating substances.

4 ALBERT EMBANKMENT
LONDON SE1 7SR
Telephone: +44 (0)20 7735 7611 Fax: +44 (0)20 7587 3210

MSC.1/Circ.1590
11 June 2018

**UNIFIED INTERPRETATION OF PARAGRAPH 13.3.5 OF THE IGC CODE
(AS AMENDED BY RESOLUTION MSC.370(93))**

1 The Maritime Safety Committee, at its ninety-ninth session (16 to 25 May 2018), with a view to providing more specific guidance on the expression "each dry-docking" in the context of testing of high-level alarms on liquefied gas tankers, approved the following unified interpretation of paragraph 13.3.5 of the International Code of the Construction and Equipment of Ships Carrying Liquefied Gases in Bulk (IGC Code) (as amended by resolution MSC.370(93)), prepared by the Sub-Committee on Carriage of Cargoes and Containers, at its fourth session:

**UNIFIED INTERPRETATION OF PARAGRAPH 13.3.5 OF THE IGC CODE
(AS AMENDED BY RESOLUTION MSC.370(93))**

Testing of high-level alarms

The expression "each dry-docking" is considered to be the survey of the outside of the ship's bottom required for the renewal of the Cargo Ship Safety Construction Certificate and/or the Cargo Ship Safety Certificate.

2 Member States are invited to use the above unified interpretation as guidance when applying the relevant provision of the IGC Code and to bring it to the attention of all parties concerned.

4 ALBERT EMBANKMENT
LONDON SE1 7SR
Telephone: +44 (0)20 7735 7611 Fax: +44 (0)20 7587 3210

MSC.1/Circ.1591
11 June 2018

UNIFIED INTERPRETATIONS OF THE IGF CODE

1 The Maritime Safety Committee, at its ninety-ninth session (16 to 25 May 2018), with a view to providing more specific guidance for the application of the relevant requirements of the International Code of Safety for Ships using Gases or other Low-flashpoint Fuels (IGF Code), approved unified interpretations of the Code, prepared by the Sub-Committee on Carriage of Cargoes and Containers, at its fourth session, as set out in the annex.

2 Member States are invited to use the annexed unified interpretations as guidance when applying relevant provisions of the IGF Code and to bring them to the attention of all parties concerned.

ANNEX

UNIFIED INTERPRETATIONS OF THE IGF CODE

1 Storage tanks loading limits higher than calculated using the reference temperature (paragraph 6.8.2)

The alternative loading limit option given under 6.8.2 is understood to be an alternative to 6.8.1 and should only be applicable when the calculated loading limit using the formulae in 6.8.1 gives a lower value than 95%.

2 Other rooms with high fire risk (paragraph 11.3.3)

The following "other rooms with high fire risk" should as a minimum be considered, but not be restricted to:

- .1 cargo spaces except cargo tanks for liquids with flashpoint above 60°C and except cargo spaces exempted in accordance with SOLAS regulations II-2/10.7.1.2 or II-2/10.7.1.4;
- .2 vehicle, ro-ro and special category spaces;
- .3 service spaces (high risk): galleys, pantries containing cooking appliances, saunas, paint lockers and store-rooms having areas of 4 m² or more, spaces for the storage of flammable liquids and workshops other than those forming part of the machinery space, as provided in SOLAS regulations II-2/9.2.2.4, II-2/9.2.3.3 and II-2/9.2.4; and
- .4 accommodation spaces of greater fire risk: saunas, sale shops, barber shops and beauty parlours and public spaces containing furniture and furnishing of other than restricted fire risk and having deck area of 50 m² or more, as provided in SOLAS regulation II-2/9.2.2.3.

3 Level indicator in the bilge well of tank connection spaces of independent liquefied gas storage tanks (paragraph 15.3.2)

The "level indicator" required by 15.3.2 of the IGF Code is understood to be required for the purposes of indicating an alarm status only; a level switch (float switch) is an instrument example considered to meet this requirement.

4 Testing of high level alarms (paragraph 15.4.2.3)

The expression "each dry-docking" refers to:

- .1 for cargo ships, the survey of the outside of the ship's bottom required for the renewal of the Cargo Ship Safety Construction Certificate and/or the Cargo Ship Safety Certificate; and
- .2 for passenger ships, the survey of the outside of the ship's bottom to be carried out according to paragraphs 5.10.1 and 5.10.2 of the *Survey Guidelines under the Harmonized System of Survey and Certification, (HSSC), 2017* (resolution A.1121(30), as may be amended).

4 ALBERT EMBANKMENT
LONDON SE1 7SR
Telephone: +44 (0)20 7735 7611 Fax: +44 (0)20 7587 3210

MSC.1/Circ.1594
25 May 2018

**AMENDMENTS TO THE INTERNATIONAL AERONAUTICAL
AND MARITIME SEARCH AND RESCUE (IAMSAR) MANUAL**

1 The Maritime Safety Committee (MSC), at its ninety-ninth session (16 to 25 May 2018), having been informed that the International Civil Aviation Organization (ICAO) had approved the amendments to the IAMSAR Manual prepared by the ICAO/IMO Joint Working Group on Harmonization of Aeronautical and Maritime Search and Rescue, and that they had been endorsed by the Sub-Committee on Navigation, Communications and Search and Rescue (NCSR) at its fifth session (19 to 23 February 2018), adopted the annexed amendments in accordance with the procedure laid down in the *Procedures for amending and updating the International Aeronautical and Maritime Search and Rescue (IAMSAR) Manual*, (resolution A.894(21), annex).

2 The Committee agreed that the amendments should become applicable on 1 July 2019.

ANNEX

AMENDMENTS¹ TO THE INTERNATIONAL AERONAUTICAL AND MARITIME SEARCH AND RESCUE (IAMSAR) MANUAL

AMENDMENTS TO IAMSAR MANUAL VOLUME I

CONTENTS

1.8 SAR and the 1949 Geneva Conventions and their Additional Protocols
Search and rescue (SAR) operations by maritime rescue services in time of
armed conflict

Appendix H National self-assessment on search and rescue system

Appendix O Sample template for a joint search and rescue exercise

ABBREVIATIONS AND ACRONYMS

ADS-B automatic dependent surveillance

ADT autonomous distress tracking

[...]

GADSS Global Aeronautical Distress and Safety System

[...]

Inmarsat an IMO recognized mobile satellite communication-service provider for the
GMDSS.

GLOSSARY

Aircraft tracking A process, established by the aircraft operator, that maintains
and updates, at standardized intervals, a ground-based record
of the four dimensional position (latitude, longitude, altitude and
time stamp) of individual aircraft in flight (ICAO Annex 6).

¹ Modifications from original text is shown in "strikeout" for deleted text and "grey shading" to highlight new insertions.

Aircraft operator	ICAO Annex 12 – <i>Search and Rescue</i> , "A person, organization or enterprise engaged in or offering to engage in an aircraft operation." This means (i) a person or company who, for compensation or hire, participates in the carriage by air transport of persons or property, or other aerial-work services using aircraft; commonly an "airline" or other type of air transport or services company and (ii) a person who owns or shares ownership of a general aviation aircraft that is used by them but not for commercial air transport purposes.
Air traffic service	A generic term meaning variously, flight information service, alerting service, air traffic advisory service, air traffic control service (area control service, approach control service or aerodrome control service).
Air traffic services unit	A generic term meaning variously, air traffic control unit, flight information centre or air traffic services reporting office.
Area remote from SAR facilities	An area within which there may be an extended SAR response time due to the incident location and/or environmental conditions.
Autonomous distress tracking	<p>The capability to transmit information from which the position of an aircraft in distress can be determined at least once every minute and which is resilient to failures of the aircraft's electrical power, navigation and communication systems.</p> <p><i>Note: this capability is described under "Location of an Aeroplane in Distress" in ICAO Annex 6, Part 1.</i></p>
IMO recognized mobile satellite service	Distress and safety communication service provided by a mobile satellite service recognized by the International Maritime Organization (IMO), for use in the GMDSS.
Mobile-satellite service	A radio communication service between mobile earth stations and one or more space stations, or between space stations used by this service; or between mobile earth stations by means of one or more space stations.

Chapter 1 – General system concept (changes MRO, ICRC)

1.3.3 Appendix M provides an overview of the relevant articles, annexes and chapters of the Convention on International Civil Aviation, the International Convention for the Safety of Life at Sea (SOLAS), and the International Convention on Maritime Search and Rescue and the Convention on International Civil Aviation.

[...]

1.5.7 Resources will be needed to gather performance data and review, analyse and recommend improvements in the SAR system and its operation. But even before a new system is started, a needs and capabilities analysis should be conducted. Chapters 5 and 6 will help with these efforts.

1.5.8 SAR cases, accidents, exercises and drills should be carefully assessed and potential improvements to the SAR system identified. Lessons identified in such cases, and other information of use to the SAR community, should be shared as appropriate at local, national, regional and/or international level. States should consider whether to make formal reports to IMO and/or ICAO. The International Maritime Rescue Federation also provides an information-sharing platform: see Appendix D "Information sources".

1.5.9 It is important to note the distinction between a "lesson identified" and a "lesson learned". Lessons from SAR events may be identified by SAR authorities, responders, investigation authorities and others involved. These lessons should be analysed and decisions made about what actions may be required as a result. Once actions are agreed, effort, resource and time are required to implement them. Only when the actions have been fully implemented can the lessons be said to have been learned.

1.5.810 Commitments of various agencies and States to support the SAR system are often documented in a variety of plans, agreements, memoranda of understanding, etc. [...]

(Renumber subsequent subparagraphs in this section)

[...]

Replace Section 1.8 as follows:

~~1.8~~ **SAR and the 1949 Geneva Conventions and their Additional Protocols**

~~1.8.1~~ In times of armed conflict, SAR services will normally continue to be provided in accordance with the Second Geneva Convention of 1949 (Geneva Convention for the Amelioration of the Condition of Wounded, Sick and Shipwrecked Members of Armed Forces at Sea, of 12 August 1949) and Additional Protocol I to the Conventions.

~~(a)~~ The SAR services recognized by their Administrations are afforded protection for their humanitarian missions so far as operational requirements permit. Such protection applies to coastal rescue craft, their personnel and fixed coastal SAR installations, including RCCs and RSCs as far as these centres are located in coastal areas and are used exclusively to coordinate search and rescue

~~operations. SAR personnel should be informed about their Administration's status regarding, and views on, implementation of the Second Geneva Convention and its Additional Protocol I.~~

- ~~(b) Chapter XIV of the International Code of Signals illustrates the different means of identification which shall be used to provide effective protection for rescue craft.~~
- ~~(c) The above-mentioned coastal installations should, in time of armed conflict, display the distinctive emblem (red cross or red crescent), according to regulations issued by their competent authorities.~~
- ~~(d) It is recommended that Parties to a conflict notify the other Parties with the name, description and locations (or area of activity) of their above-mentioned rescue craft and coastal installations in the area they are located.~~

1.8 Search and rescue operations (SAR) by maritime rescue services in time of armed conflict

Note – The guidance contained in section 1.8 has been prepared by the International Committee of the Red Cross.

1.8.1 The four Geneva Conventions of 1949 and their Additional Protocols of 1977 are the bedrock of international humanitarian law (IHL). IHL is a body of law underpinned by the principle of respect for the life and dignity of the individual in situations of armed conflict. The second of the four Geneva Conventions (GC II) concerns armed conflicts that take place wholly or in part at sea and extends this principle to the wounded, sick and shipwrecked members of the armed forces at sea. Recognizing the important role search and rescue operations play in implementing its provisions, GC II extends protection to small coastal rescue craft and fixed coastal rescue installations used by such craft, such as rescue coordination centres, repair boats, sickbays and hangars for their humanitarian mission, including for SAR operations concerning civilians.

1.8.2 Such craft and their associated fixed coastal rescue installations, when employed by a State that is party to a conflict (whether by its armed forces or by civilian governmental agencies) or by officially recognized lifeboat institutions (i.e. the institution must have been approved or authorized by a governmental authority or other public body to perform coastal rescue functions, which presupposes the existence of a legal or administrative framework in the State in which the lifeboat institution operates to provide for its prior approval or authorization in peacetime) **"shall be respected and protected, that is, may not be attacked, captured or otherwise prevented from performing their humanitarian tasks, so far as operational requirements permit"**.

1.8.3 In contrast to the protection owed to large hospital ships, the concession that coastal rescue craft must be respected and protected **"so far as operational requirements permit"**, allows for operational considerations by a reasonable commander to justify interference with a rescue craft by, for example, preventing them from performing their humanitarian tasks in a given sea area. However, the rules on the conduct of hostilities, as set out in Additional Protocol I of 1977 (API), apply in parallel and an attacker would not be absolved from the fundamental obligations to target only military objectives, to take all feasible precautions and to refrain from attacks that would be indiscriminate.

- 1.8.4** Neutral coastal rescue craft (i.e. craft of a State which is not a Party to an armed conflict between two or more other States) enjoy protection under other sources of international law and may also obtain special protection under GC II. Neutral vessels that agree to take on board and care for the wounded, sick and shipwrecked and to collect the dead "shall enjoy special protection and facilities to carry out such assistance".
- 1.8.5** The marking of coastal rescue craft in times of armed conflict is not constitutive of their protection but merely facilitates their identification by parties to the conflict. GC II provides that all exterior surfaces of the craft shall be white and that one or more dark red crosses or other emblems recognized by international humanitarian law, in particular the red crescent and the red crystal, shall be displayed on each side of the hull and on the horizontal surfaces. Although the Convention is silent on the marking of fixed coastal installations, it is reasonable that they may, in wartime, display the distinctive emblem of the red cross, the red crescent or the red crystal on a white background.
- 1.8.6** These traditional marking methods might not suffice to ensure the proper identification of protected vessels in view of modern techniques of naval warfare, such as long-fire and submarine capabilities. Under GC II, the parties to the conflict are encouraged to conclude special agreements on the "most modern methods available to facilitate the identification of hospital ships". There is no reason why agreements could not also be concluded for coastal rescue craft. Such agreements could be critical to ensure that protected craft are effectively identified by parties to the conflict, and given the protection to which they are entitled in order to carry out their humanitarian work.
- 1.8.7** GC II moreover requires that the parties to the conflict be notified of the names and characteristics of coastal rescue craft at least ten days before they are used in wartime. This requirement is dispensed with in API, although the parties are invited to inform each other of any details of such craft which will facilitate their identification and recognition. In addition, GC II provides that rescue craft employed by private lifeboat institutions must have received an official commission and provided with certificates from the responsible authorities stating that they have been under proper control. Furthermore, to benefit from the protection of GC II the rescue craft must not be used for any military purpose and must not hamper the movements of combatants. They must also afford relief and assistance to the wounded, sick and shipwrecked without distinction of nationality.

Chapter 2 – System components

[...]

2.5.2 The equipment needed by SRUs may be grouped as shown.

- (a) *Communications.* An SRU must have rapid and reliable means to communicate by voice or message with the SMC, the OSC if assigned, other SRUs, and the distressed persons. Chapter 4 has more information on SRU communications requirements.
- (b) *Mobility.* The effectiveness of a SAR service depends on the number, speed, location, and efficiency of the aircraft, vessels and land vehicles available.
- (c) *Supplies and survival equipment.* Supplies and survival equipment are carried by air and maritime SAR facilities to give aid to survivors and to facilitate their rescue. The type and number to be carried depend on the circumstances on scene. Maritime facilities and helicopters generally can deliver this equipment directly to survivors. Fixed-wing aircraft can deliver supplies to survivors if suitable landing areas exist nearby or if the supplies can be dropped at the scene. The packing of supplies and survival equipment should be adapted to the manner of delivery. Containers and packages of supplies and survival equipment should be strong, of a highly visible colour, waterproof and buoyant. The general nature of their contents should be clearly indicated in print in English and ~~two or more other~~ additional languages appropriate to the intended area of operation or using self-explanatory symbols, ~~and may also be indicated by colour-coded streamers~~ and pictograms as discussed in appendix B. Supplies and survival equipment requirements must be adapted to the circumstances of the SRR in which they are used.
- (d) *Other equipment.* Every SRU should have at its disposal maps, charts, plotting equipment, and information relevant to the SRR(s) in which it is likely to operate.

Chapter 3 – Training, qualification, certification and exercises

3.3.1 Exercises test and improve operational plans, provide learning experience and improve liaison and coordination skills. Exercises, conducted on a realistic basis, help to demonstrate and assess the true effectiveness of training and the operational efficiency and competence of the SAR service. Exercises will reveal deficiencies that may exist in SAR plans and enable them to be improved. It is safer to have shortcomings revealed by exercises rather than during actual operations. Appendix O provides a sample template to serve as a guide to assist a State to develop a SAR exercise with its local SAR supporting agencies as well as with one or more neighbouring States.

Chapter 4 – Communications

4.4.10 [...] There are also a variety of satellite systems used for navigation and for finding the search ~~objects~~ targets.

Chapter 5 – System management

[...]

5.1.7 Each State should assess its own responsibilities and requirements and then evaluate its abilities as a SAR service provider for both national and regional needs. Whether establishing a SAR system or conducting a periodic review of an established one, assessments provide a factual basis on which to make improvements. Such

assessments also help to gain continued support for SAR system funding, to obtain assistance from other agencies, or to justify procurement of additional resources. Appendix H contains a national self-assessment questionnaire which may be used to evaluate international and national SAR systems aligned to ICAO and IMO SAR obligations, to identify areas for improvement, and to assist SAR managers in assessing needs. The questionnaire may be used for conducting a periodic review of an established SAR system or as a support tool to guide the establishment of a SAR system.

[...]

5.4 Resources

Obtaining resources

[...]

5.4.5 In some circumstances there may be a need for immediate response to large numbers of persons in distress such that the capabilities normally available to the SAR authorities are inadequate. These are known as mass rescue operations: see chapter 6. SAR managers should plan to acquire the extra resources necessary for such operations by

- agreeing to share SAR facilities regionally and/or internationally;
- identifying additional SAR facilities locally, including shipping in the area; and
- identifying ways of providing support to persons in distress until they can be rescued.

[...]

Chapter 6 – Improving services

[...]

6.4 Cooperating to improve services ***Need for SAR managers to involve others***

Amend section 6.4 as follows:

- insert three paragraphs at the beginning (6.4.1 through 6.4.3);
- renumber prior paragraphs 6.4.1 and 6.4.2 into paragraphs 6.4.4 and 6.4.5;
- insert new paragraph 6.4.6 (in front of prior paragraph 6.4.3);
- renumber prior paragraph 6.4.3 to 6.4.7
- renumber prior paragraph 6.4.4 to 6.4.8
- insert new paragraph 6.4.9 (in front of prior paragraph 6.4.5)
- renumber prior paragraph 6.4.5 to 6.4.10
- renumber prior paragraph 6.4.6 to 6.4.11

6.4 Cooperating to improve services

Need for SAR managers to involve others

6.4.1 National and international expectations have greatly increased for SAR services to effectively and efficiently conduct SAR operations. News media, next of kin of victims and others provide constant attention to SAR incidents and loss of life, and are quick to question the competency of a response. Lessons learned from previous disasters and their respective SAR responses have demonstrated that effective cooperation and coordination between a State's SAR services and with other national SAR services is a critical component to any national SAR system.

6.4.2 A national SAR system is comprised of three components that form a triangle:

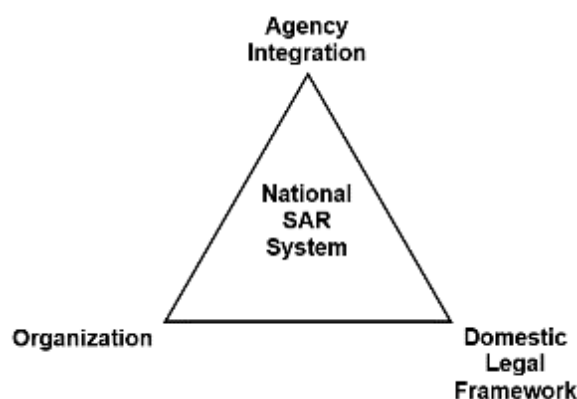

- Domestic Legal Framework: A State must have the domestic legal framework in place to implement a national SAR system to meet its international SAR commitments under the SOLAS Convention, the International Convention on Maritime Search and Rescue, and the Convention on International Civil Aviation. Within the domestic legal framework, States provide agency-specific legal authorities for the conduct of SAR.
- Organization: Built upon a State's domestic legal framework, national and agency-specific SAR organization, policy, and procedures must be developed and implemented. A national SAR system should be organized to promote the use of all available government agencies, industry stakeholders and volunteer organizations and resources to save lives. Funding and SAR resources must be made available to SAR authorities; training must be provided to ensure SAR planners and responders can effectively perform their assigned responsibilities.
- Agency integration: Agency Integration is perhaps the most critical component to any national SAR system. A State may have the domestic legal framework in place and have organized a national SAR system; however, if people, organizations and agencies are unwilling to work together to collaborate, cooperate, coordinate, manage and conduct SAR operations, then lives may be lost.

6.4.3 From a SAR system perspective, effective agency integration can be considered the willingness of people, agencies and organizations to work together within a national SAR system. Barriers to effective agency integration include:

- Agencies may be unwilling to share information and SAR resources. This is a particular concern between aeronautical and maritime SAR authorities: States may have fulfilled their international obligations concerning implementing a national SAR system, however, SAR agencies/organizations and personnel may be unwilling or unable to work together. This problem also occurs between a State's civil SAR authorities and the military. The unwillingness of civil and military authorities to coordinate and conduct SAR operations can hamper an effective SAR response.
- Narrowly and rigidly defined agency responsibilities are strictly adhered to. As a result, there may be an unwillingness to assist in the coordination and conduct of SAR operations if a particular response is considered to be outside the scope of an agency's normal responsibilities.
- Agencies are unwilling or reluctant to go through the process of improving SAR coordination, cooperation and response. Many may believe it is easier to keep the status quo rather than to improve a national SAR system.
- The belief that there may be a loss of power or position if an agency/organization begins to collaborate and cooperate on SAR operations.

6.4.14 Managers should understand...

6.4.25 SAR managers should associate with others to:

- ~~collaborate with and~~ develop teamwork with other SAR personnel, suppliers and support agencies and with SAR personnel and organizations of other States;
- improve communications and understanding between SAR organizations and other emergency response agencies, including mutual understanding of risk factors, response roles and capabilities, and operational terminology;
- do both short- and long- term planning for SAR services;
- focus on continuous improvement and error prevention to provide the best SAR services possible; and
- develop support of top management.

6.4.6 To minimize the lack of agency integration in a national SAR system, two factors should be considered:

- establishment of a national SAR coordinating committee.
- creation of a national SAR plan.

6.4.37 An effective process for SAR coordination is the establishment and use of SAR coordinating committees (SCCs) comprising SAR system stakeholders to provide a strategic, whole-of-government approach to national SAR system cooperation and coordination. These The SCC can be established at SAR agency, national or regional level, and, ideally, at all three levels. SAR agency SCCs should deal with local

operational SAR issues and have the ability to refer matters higher if required. Committees established at a national level may consider strategic SAR policy matters and should have the ability to take matters to their respective governments for consideration. Regional SCCs should be able to refer SAR matters of a regional nature to their incorporated national committees for consideration. The establishment of these SAR committees can improve and support the SAR system in a number of ways, including:

- develop and recommend national strategic policy to their respective governments;
- remove agency integration barriers by managing issues related to SAR policy, processes, organization, the sharing of best practices and lessons learned, as well as other areas to promote SAR cooperation;
- provide a standing forum for coordination of administrative and operational SAR matters;
- develop plans, policies, positions, manuals, etc., to:
 - resolve cross-agency jurisdictional issues;
 - develop joint solutions for SAR matters of common concern;
 - assign and coordinate SAR responsibilities;
 - develop and implement SAR requirements and standards;
 - establish agreements, requirements and/or guidelines for SAR services and others operating in areas remote from SAR facilities;
 - the SAR authorities should define areas remote from SAR facilities within their SRR as necessary;
 - the SAR authorities should identify conditions (e.g. weather, terrain, Seasonal icing, sea state, etc.) in areas remote from SAR facilities, for the purpose of providing unique processes and procedures including contingency plans;
- effectively use all available resources for SAR, including global, regional, national, private, commercial, and volunteer resources (such resources may include advice, communications facilities and databases, ship reporting systems, training, SAR facilities, search planning expertise, technical assistance, foreign language assistance, medical or fueling facilities, regulatory support and others);
- develop common equipment, facilities and procedures as appropriate;
- interface with other national and international organizations involved with emergency services;
- promote close cooperation and coordination between civilian and military authorities and organizations for the provision of effective SAR services;
- serve as a cooperative forum to exchange information and develop positions and policies of interest to more than one member agency;

- improve cooperation, communication and understanding among aeronautical, maritime and land SAR communities;
- determine ways to enhance overall effectiveness and efficiency of SAR services;
- promote safety programmes to help citizens avoid or cope with distress situations; and
- develop contingency plans for use of SAR resources during disasters.

6.4.48 A national SAR plan or a regional SAR agreement should establish an SCC. This provides the process for SAR cooperation and coordination. Participating organizations would include those directly involved with SAR and those in a supporting role.

6.4.9 The national SAR plan or a regional SAR agreement should also contain any written agreement, which involves the sharing of responsibilities when conducting SAR missions in areas remote from SAR facilities, and provide details on how responsibilities are assigned.

Renumber existing paragraphs:

6.4.5 to **6.4.10**

6.4.6 to **6.4.11**

[...]

6.5 Reducing response time

6.5.4 To improve SAR communications, SAR authorities should consider initiatives like the following:

- ensure that suitable national legislation and regulations are in place and support international aeronautical and maritime mobile service developments;
- reduce total communication facility shortfalls and costs by sharing facilities between organizations or States with similar needs, and to serve multiple units which are co-located, or which can be suitably connected;
- establish written communications maintenance plans, and written policies for communications procedures, reports, files and logs;
- use landline, cable, or microwave when possible for point-to-point or fixed communications;
- use the most efficient signal characteristics and control techniques commensurate with required reliability, speed, and traffic volume for long-range communications and line-of-sight techniques for short-range communications;
- provide compatible communications for civil and military facilities used for SAR to the maximum extent possible;
- provide equipment and personnel adequate to handle both operational communications and distress, urgency and safety communications;

- ensure that communications can be carried out rapidly with operating facilities, and that high-priority messages can be routed quickly;
- ensure that personnel from different organizations are able to understand each other's communications, especially matters concerning priority and risk;
- arrange for communications personnel to report observed frequency violations to enforcement authorities;
- establish communications reliability goals for the coverage areas and assess performance;
- institutionalize sufficient training for proper operation and administration of communication facilities;
- ensure that commercial proprietary information, such as ship reports for SAR, remains proprietary and used only for SAR or safety purposes, to help safeguard continued availability of this information;
- ensure that distress communications are always recognized and handled as a higher priority than logistic, administrative, training and routine operational communications;
- where practicable, enable SAR personnel to communicate directly with potential craft in distress, including aircraft, ships, fishing vessels, recreation vessels and other types of marine craft;
- provide comprehensive distress communications throughout SRRs, but especially along the coast and over land;
- use automation techniques and phone patch capabilities to keep resource needs reasonable as workloads increase;
- ensure that communications funding needs are included in SAR agency and SAR facility budget plans;
- address personnel qualification and replacement needs from both a SAR and communications perspective;
- prepare radio coverage charts;
- develop written test and casualty restoration procedures; and
- cooperate with other organizations to provide disaster-recovery sites for each other for crucial alerting posts, computer centres and RCCs.

[...]

6.5.5 The following are some measures which SAR authorities can help implement to improve the land portion of distress alerting:

- use dedicated circuits for land connection to RCCs from land facilities such as LESs, DSC coast stations, and MCCs and use switching and software arrangements to preserve message priority;

- in areas of unreliable landline operations, equip RCCs with ~~Inmarsat~~ IMO recognized mobile satellite service ground terminal stations or other means of mobile satellite communications to facilitate emergency communications between RCCs or to enable direct communications with aircraft (which are now more and more being fitted with satellite communication (satcom) equipment linked to LESs);
- upgrade circuits connecting RCCs with LESs and DSC coast stations using caller identification displays, where practicable, at the RCC for messages from vessels using ~~Inmarsat~~ an IMO recognized mobile satellite service or DSC-initiated radiotelephone; and
- provide appropriate computer software to automatically decode message contents not in plain language prior to delivery of distress alerts to the RCC and automatically retrieve supporting emergency data on distressed aircraft and vessels from available databases as soon as possible for delivery to the RCC.

[...]

6.6 Mass rescue operations

- 6.6.1** A mass rescue operation (MRO) is ~~one that involves~~ characterized by a need for immediate ~~assistance response~~ to large numbers of persons in distress such that capabilities normally available to SAR authorities are inadequate.
- 6.6.2** MROs ~~are required~~ occur less frequently than typical rescue efforts, but have high potential consequences. Flooding, earthquakes, terrorism, and large passenger aircraft or ship disasters are examples of scenarios that may involve the need for MROs. Extensive preparations and resources are required to conduct MROs successfully.
- 6.6.3** Such incidents might involve hundreds or thousands of persons in distress in remote and hostile environments. A large passenger ship collision, for example, could call for rescue of thousands of passengers and crew in poor weather and sea conditions, with many of the survivors having little ability to help themselves. Preparedness to mount a large and rapid response would be critical to preventing large-scale loss of lives.
- 6.6.4** MRO ~~plans incidents~~ and exercises are complex and challenging and ~~relatively complex~~. It is essential to plan for the effective use of additional resources, ~~Effective arrangements for use of national and often international resources~~ beyond those normally used for SAR ~~are essential~~. Preparations require substantial commitments and partnerships among SAR authorities, regulatory authorities, transportation companies, sources of military and commercial assistance and others, often at the international as well as the national level.
- 6.6.5** MROs often need to be carried out and coordinated within a broader emergency response context that may involve hazards mitigation, damage control and salvage operations, pollution control, complex traffic management, large-scale logistics, medical and coroner functions, accident-incident investigation, and intense public and political attention, etc. Efforts must often start immediately at an intense level and be sustainable for days or weeks.
- 6.6.6** SAR authorities should coordinate MRO plans with companies that operate aircraft and ships designed to carry large numbers of persons. Such companies should share in preparations to prevent MROs and to help ensure success if they become necessary.

6.6.7 What the News and social media reports may matter more than what SAR authorities services and operators do for in shaping of public opinion about MROs. There should be no unwarranted delays in providing information to the media. Information must be readily available, and freely exchanged among emergency service providers and shipping, airline or other primary companies involved.

6.6.8 Since opportunities to handle actual incidents involving mass rescues are rare and challenging, exercising MRO plans is particularly important.

6.6.9 It is the SAR Coordinator's responsibility to engage with response organizations and to coordinate the necessary MRO planning, or to ensure that it is coordinated by a nominated authority. It is with the SAR Coordinator that MRO preparation begins.

6.6.10 SAR managers' responsibilities in terms of MRO planning may be summarized as follows:

- Recognize the need for MRO preparation.
- Liaise with the SAR Coordinator and all organizations with a potential response role, to identify individual organizations' responsibilities and capabilities and to develop measures to mitigate shortfalls in overall MRO capability.
- Establish and support a coordinated planning process.
- Ensure that the planning includes the necessary additional SAR resource, including staffing, equipment, management, coordination and communications resources.
- Ensure that the planning includes the necessary training and testing regimes
- Ensure that any necessary legal provisions are in place.
- Ensure that sufficient funding is in place for the planning and preparation phases, and that policies are agreed that will ensure that any cost questions arising at the time of an MRO will not delay response.
- Ensure that the resulting plans are understood and agreed by all who will have to implement them, and that they are kept current.

6.6.11 The International Maritime Rescue Federation (IMRF) has developed detailed guidance on preparing for maritime MROs. This may be downloaded from www.imrfmro.org.

Appendix B

Supply colour coding and pictograms

1 Containers or packages containing survival equipment for dropping to survivors should have the general nature of their contents indicated by a colour code and by printed indication and self-explanatory symbols.

2 The colour identification of the contents of droppable containers and packages containing survival equipment should take the form of streamers coloured according to the following code:

RED: Medical supplies and first aid equipment.

BLUE: Food and water.

YELLOW: Blankets and protective clothing.

BLACK: Miscellaneous equipment such as stoves, axes, compasses, and cooking utensils.

32 Bands of suitable pictograms in retroreflective material should also be used. Pictograms are shown in figure B-1.

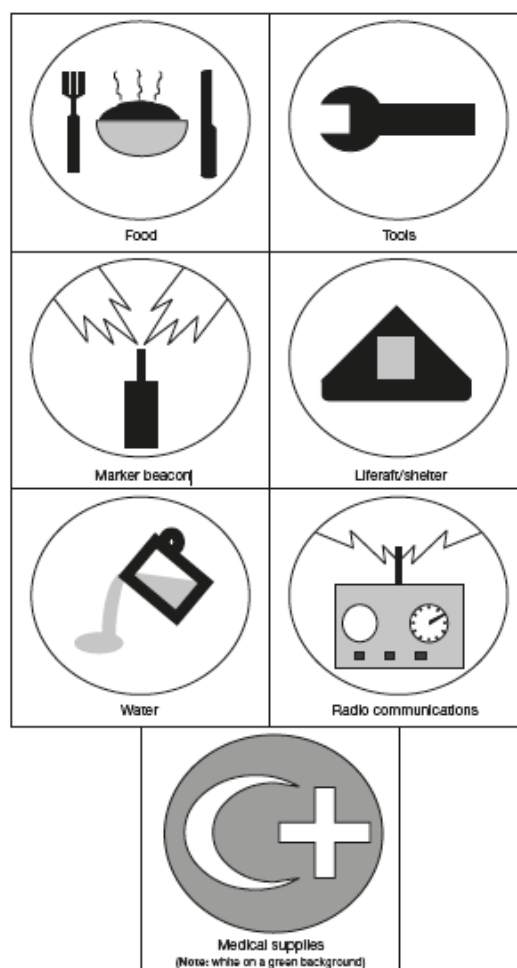

Figure B-1

Appendix D

Information sources

Add the following text to the end of the list of organizations in the Appendix:

In addition to providing help in obtaining the reference documents mentioned in this Manual, the International Maritime Rescue Federation (IMRF) shares information on SAR lessons identified and other information sourced from the SAR community.

Useful SAR information may be found at www.international-maritime-rescue.org and/or may be requested from, or supplied to, the IMRF at info@imrf.org.uk.

Appendix G

Mobile communication services

Amend as follows

[...]

- Insert new section G.6 and renumber subsequent sections accordingly

G.6 Global Aeronautical Distress and Safety System

G.6.1 The Global Aeronautical Distress and Safety System (GADSS) is a system of systems and procedures that will apply initially to commercial air transport operations, under ICAO Annex 6, Part 1 applicability. It may also extend to other civil air transport operations. The GADSS consists of the following main system components:

- aircraft tracking function;
- autonomous distress tracking (ADT) function;
- post flight localization and recovery function; and
- GADSS information management procedures.

The ADT function is applicable from 1 January 2021 for certain aircraft as described in G.6.3.

G.6.2 The objectives of the GADSS are to:

- ensure timely detection of aircraft in distress;
- initiate timely SAR actions;
- ensure tracking of aircraft in distress and timely and accurate location of end of flight;
- accurately direct SAR actions;
- enable efficient and effective SAR operations; and
- ensure timely retrieval of Flight Recorder Data.

G.6.3 The aircraft tracking capability will enhance the ability for RCCs to obtain information on an aircraft in an emergency situation but also to provide information on other aircraft in the area that may be able to assist, for example divert to a distress location, relay communications, etc.

Note: See ICAO Annex 6 — *Operation of Aircraft, Part I — International Commercial Air Transport — Aeroplanes* paragraph 3.5.1

3.5 AIRCRAFT TRACKING

(Applicable on and after 8 November 2018)

3.5.1 The operator shall establish an aircraft tracking capability to track aeroplanes throughout its area of operations.

Note.— *Guidance on aircraft tracking capabilities is contained in the Normal Aircraft Tracking Implementation Guidelines (Cir 347).*

3.5.2 **Recommendation.**— *The operator should track the position of an aeroplane through automated reporting at least every 15 minutes for the portion(s) of the in-flight operation(s) under the following conditions:*

a) *the aeroplane has a maximum certificated take-off mass of over 27 000 kg and a seating capacity greater than 19; and*

b) *where an ATS unit obtains aeroplane position information at greater than 15 minute intervals.*

Note.— *See Annex 11, Chapter 2, for coordination between the operator and air traffic services providers regarding position report messages.*

3.5.3 *The operator shall track the position of an aeroplane through automated reporting at least every 15 minutes for the portion(s) of the in-flight operation(s) that is planned in an oceanic area(s) under the following conditions:*

a) *the aeroplane has a maximum certificated take-off mass of over 45 500 kg and a seating capacity greater than 19; and*

b) *where an ATS unit obtains aeroplane position information at greater than 15 minute intervals.*

Note 1.— *Oceanic area, for the purpose of aircraft tracking, is the airspace which overlies waters outside the territory of a State.*

Note 2.— *See Annex 11, Chapter 2, for coordination between the operator and air traffic services providers regarding position report messages.*

3.5.4 *The operator shall establish procedures, approved by the State of the Operator, for the retention of aircraft tracking data to assist SAR in determining the last known position of the aircraft.*

G.4 Aircraft tracking is a core component of GADSS. The automated four-dimensional (latitude, longitude, altitude and time) position reports are to be transmitted at an interval of 15 minutes or less (recommended in all areas of operation and required in oceanic areas). Any missed aircraft position reports identified by the aircraft tracking system will be used in the provision of alerting service described in Annex 11 – *Air Traffic Services* Chapter 5.

G.5 Independent and separate from the aircraft tracking capability, ADT is used to provide distress alerting and identification of the location of an aircraft in distress with the aim of establishing, to a reasonable extent, the location of an accident site within a 6 NM radius. As per the Annex 6 standards referenced above, and as of 1 January 2021, new aircraft with a take-off mass greater than 27,000 kilograms will have an ADT capability. (The possibility to omit one of the two required ELTs when an ADT system is installed could act as an incentive to retrofit older aircraft.) ADT will use on board systems to broadcast aircraft position (latitude and longitude), or distinctive distress signals from which the aircraft position and time can be derived. The aircraft position information will be transmitted, without the need for flight crew action, at least once every minute, when an aircraft is in a distress condition.

G.6.6 When it is identified that an aircraft is considered to be in a state of emergency, the RCC will be alerted. The alerting process envisaged in the GADSS is consistent with the current ATS alerting service provisions of ICAO Annex 11 — *Air Traffic Services* and Annex 12 — *Search and Rescue*.

- If an ATS unit detects a distress condition it will notify the RCC and the operator.

- If the operator detects a distress condition it will notify the ATS unit who will in turn notify the RCC.

- If an ELT is activated the RCC will be notified via the Cospas-Sarsat system.

- If the RCC receives the information from other sources, the RCC will identify to which emergency phase the situation corresponds and shall apply the procedures applicable to that phase.

G.6.7 The sharing of GADSS alerting information requires global coverage and a global interoperable systems approach. Aircraft tracking and ADT alert information for aircraft emergency conditions needs to be made rapidly available to the aircraft operator, the appropriate ATS unit and RCC, and other designated recipients/stakeholders. Effective sharing of this information to the responsible stakeholders requires well defined, accurate and readily accessible global FIR and SRR data, plus reliable emergency 24-hour contact details for the aircraft operators, ATS units and RCC.

Appendix H

National self-assessment on search and rescue

- Replace existing Appendix H as follows:

National self-assessment on search and rescue **system**

This questionnaire may be used for:

- Conducting a periodic review of an established SAR system; or
- Guiding the establishment of a SAR system

The questionnaire is formatted to align with the six Chapters of IAMSAR Manual Vol I.

Explanation of Table Headings:

¹ = Question number aligned with Chapters of IAMSAR Manual Volume I

² = Examples of where assessor may find evidence

³ = Assessor decision based on evidence found

⁴ = Description of evidence and assessor suggestions for improving deficiencies

SAR System Being Assessed		Date	
Assessor Name		Assessor Title/Qualification	

Chapter 1 – General system concept

No	Question ¹	Action by Assessor ²	Evaluation ³	Remarks and Improvement Areas ⁴
1	<p>Is the Government party to the following Conventions:</p> <ul style="list-style-type: none"> .1 Convention on International Civil Aviation, 1944? .2 International Convention on Maritime Search and Rescue, 1979? .3 International Convention for the Safety of Life at Sea (SOLAS), 1974? .4 Convention on the High Seas, 1958? .5 United Nations Convention on the Law of the Sea (UNCLOS), 1982? 	<ul style="list-style-type: none"> • Review documented evidence of the establishment of the service which includes a legal framework 	<ul style="list-style-type: none"> <input type="checkbox"/> Satisfactory <input type="checkbox"/> Not satisfactory 	
2	<p>Has the State established an entity, which provides, on a 24-hour basis, search and rescue (SAR) services to ensure that assistance is rendered to persons in distress:</p> <ul style="list-style-type: none"> .1 Within its territory? .2 Within its search and rescue region(s) (SRR(s)), including both aeronautical and maritime SRRs where applicable? .3 If no, has the State arranged with another State or group of States to provide SAR services? 	<ul style="list-style-type: none"> • Review documented evidence of the establishment of the service which includes a legal framework 	<ul style="list-style-type: none"> <input type="checkbox"/> Satisfactory <input type="checkbox"/> Not satisfactory 	

No	Question ¹	Action by Assessor ²	Evaluation ³	Remarks and Improvement Areas ⁴
3	<p>Which government agencies have authority and responsibility for coordination of aeronautical SAR?</p> <p>.1 Where is this authority and responsibility described (law, regulation, agreement, etc.)?</p> <p>.2 Is the same agency responsible for coordinating aeronautical SAR over both land and sea?</p> <p>.3 If no, is there another agency with this authority and responsibility?</p>	<ul style="list-style-type: none"> • Review documented evidence of the establishment of the service which includes a legal framework • Review Aeronautical Information Publication (AIP) documenting SAR service 	<input type="checkbox"/> Satisfactory <input type="checkbox"/> Not satisfactory	
4	<p>Which government agencies have authority and responsibility for coordination of maritime SAR?</p> <p>.1 Where is this authority and responsibility described (law, regulation, agreement, etc.)?</p>	<ul style="list-style-type: none"> • Review documented evidence of the establishment of the service which includes a legal framework 	<input type="checkbox"/> Satisfactory <input type="checkbox"/> Not satisfactory	
5	<p>Has the State established an Aeronautical and/or Maritime Rescue Coordination Centre (RCC) or RCCs to coordinate aeronautical and maritime SAR operations in each of its SRRs?</p> <p>.1 Where separate aeronautical and maritime RCCs (ARCCs and MRCCs) serve the same area, does the State ensure that there is the closest practicable coordination between the centres?</p> <p>.2 Where separate Rescue Sub-Centres (RSCs) are established, do the RSCs effectively support the parent RCCs?</p>	<ul style="list-style-type: none"> • Review the legislation which establishes the RCCs/RSCs • Review actual SAR cases • When applicable, review the coordination process between ARCCs and MRCCs, and between RCCs and RSCs • Review the SAR organization 	<input type="checkbox"/> Satisfactory <input type="checkbox"/> Not satisfactory	

No	Question ¹	Action by Assessor ²	Evaluation ³	Remarks and Improvement Areas ⁴
6	<p>Where the State has responsibility for providing both aeronautical and maritime SAR services, has the State established a Joint RCC (JRCC) to coordinate both aeronautical and maritime SAR operations?</p> <p>.1 If no, has the State conducted an assessment of the merits of establishing a JRCC?</p>	<ul style="list-style-type: none"> • Review the legislation which establishes the JRCC • Review the SAR organization • Review JRCC assessment report 	<input type="checkbox"/> Satisfactory <input type="checkbox"/> Not satisfactory <input type="checkbox"/> Not applicable	
7	<p>Does the State ensure close cooperation between civil and military organizations for SAR operations?</p>	<ul style="list-style-type: none"> • Review documented evidence of the establishment of the service which includes a legal framework • Review actual SAR cases 	<input type="checkbox"/> Satisfactory <input type="checkbox"/> Not satisfactory	
8	<p>Does the State have a national SAR plan, which describes the roles of all government and non-government organizations which have resources that can support SAR?</p> <p>.1 Is there a formal national SAR coordinating committee to coordinate the actions of the organizations within the national SAR plan?</p> <p>.2 Does the State have plans and procedures for Mass Rescue Operations (MROs), On Scene Coordinator (OSC) and Aircraft Coordinator (ACO)?</p>	<ul style="list-style-type: none"> • Review documented evidence of the establishment of the plan(s) 	<input type="checkbox"/> Satisfactory <input type="checkbox"/> Not satisfactory	

No	Question ¹	Action by Assessor ²	Evaluation ³	Remarks and Improvement Areas ⁴
	.3 Does the State have plans and procedures for SAR in areas remote from SAR facilities?			
9	<p>Have there been any problems encountered when working with RCCs outside the State's SRR(s)?</p> <p>.1 If so, have steps been taken to solve these problems?</p>	<ul style="list-style-type: none"> • Review documented evidence 	<input type="checkbox"/> Satisfactory <input type="checkbox"/> Not satisfactory	9
10	<p>Have ICAO and IMO been provided with up-to-date information on your RCCs, RSCs, SAR resources and areas of responsibility, including:</p> <p>.1 national authority responsible for the search and rescue services;</p> <p>.2 location of the established rescue coordination centres or other centres providing search and rescue coordination, for the search and rescue region or regions and communications therein;</p> <p>.3 limits of search and rescue region or regions and the coverage provided by shore-based distress and safety communication facilities; and</p> <p>.4 principal types of available search and rescue units.</p>	<ul style="list-style-type: none"> • Review documented evidence including ICAO Electronic Regional Air Navigation Plan (eANP) and IMO Global Integrated Shipping Information System (GISIS). 	<input type="checkbox"/> Satisfactory <input type="checkbox"/> Not satisfactory	10

Chapter 2 – System components

No	Question ¹	Action by Assessor ²	Evaluation ³	Remarks and Improvement Areas ⁴
11	<p>Do the basic elements of SAR services include:</p> <ul style="list-style-type: none"> .1 a legal framework; .2 assignment of a responsible authority; .3 organized available resources; .4 communication facilities; .5 coordination and operational functions; and .6 processes to improve the services, including planning, domestic and international cooperative relationship and training? 	<ul style="list-style-type: none"> • Review existence of the basic elements, resources and facilities 	<ul style="list-style-type: none"> <input type="checkbox"/> Satisfactory <input type="checkbox"/> Not satisfactory 	
12	<ul style="list-style-type: none"> .1 Does the State have both aeronautical and maritime SAR regions (SRRs) or SAR subregions (SRSs) established? .2 Do the geographical limits of the State's aeronautical and maritime SRRs or SRSs coincide? .3 If the State has an aeronautical flight information region (FIR), does the aeronautical SRR have the same limits? 	<ul style="list-style-type: none"> • Review documented evidence of the establishment of the service which includes a legal framework • Review organizational structure 	<ul style="list-style-type: none"> <input type="checkbox"/> Satisfactory <input type="checkbox"/> Not satisfactory <input type="checkbox"/> Not applicable 	

No	Question ¹	Action by Assessor ²	Evaluation ³	Remarks and Improvement Areas ⁴
13	<p>.1 Have the aeronautical SRR or SRS limits been formally agreed to by neighbouring countries or jurisdictions?</p> <p>.2 Have the maritime SRR or SRS limits been formally agreed to by neighbouring countries or jurisdictions?</p> <p>.3 Are there any gaps, overlaps, or size or shape problems with national SRRs or SRSs?</p>	<ul style="list-style-type: none"> • Verify how the responsibility or authority has been delegated to another Contracting State or group of States 	<input type="checkbox"/> Satisfactory <input type="checkbox"/> Not satisfactory <input type="checkbox"/> Not applicable	
14	<p>Where aeronautical and maritime SRRs or SRSs overlap, are arrangements in place to ensure SAR operations can be coordinated effectively in the area of overlap between the RCCs responsible?</p>	<ul style="list-style-type: none"> • Verify how the responsibility or authority has been delegated to another entity or authority 	<input type="checkbox"/> Satisfactory <input type="checkbox"/> Not satisfactory <input type="checkbox"/> Not applicable	
15	<p>Do the State RCCs regularly work with each other and with other RCCs outside their regions?</p>	<ul style="list-style-type: none"> • Review documented evidence • Review actual SAR cases 	<input type="checkbox"/> Satisfactory <input type="checkbox"/> Not satisfactory	

No	Question ¹	Action by Assessor ²	Evaluation ³	Remarks and Improvement Areas ⁴
16	<p>Where separate aeronautical and maritime RCCs are established, do provisions exist for:</p> <p>.1 Aeronautical RCCs (ARCCs) to notify maritime RCCs (MRCCs) of aeronautical distress situations over the sea,</p> <p>.2 Which RCC will coordinate the incident if the aircraft ditches?</p> <p>.3 MRCCs to notify ARCCs of maritime distress situations including distress beacon activations?</p> <p>.4 ARCC(s) to assist MRCC(s) with aeronautical SAR support and MRCC(s) to assist ARCC(s) with maritime SAR support?</p>	<ul style="list-style-type: none"> • Review documented evidence 	<input type="checkbox"/> Satisfactory <input type="checkbox"/> Not satisfactory	
17	<p>Is each RCC and RSC suitably equipped to enable its staff to perform the required functions including:</p> <p>.1 communications equipment for processing of SAR alerts and coordinating SAR operations?</p> <p>.2 charts, means of recording, plotting and other applicable general office equipment?</p> <p>.3 library of SAR manuals, plans and reference material?</p> <p>.4 computer resources including databases, SAR management and planning software and internet access?</p>	<ul style="list-style-type: none"> • Review documented evidence 	<input type="checkbox"/> Satisfactory <input type="checkbox"/> Not satisfactory	

No	Question ¹	Action by Assessor ²	Evaluation ³	Remarks and Improvement Areas ⁴
18	Are RCC(s) or RSC(s) assigned to perform tasks in addition to SAR? If so, are arrangements in place to ensure that these tasks do not impact their ability to handle SAR responsibilities?	<ul style="list-style-type: none"> • Review documented evidence 	<input type="checkbox"/> Satisfactory <input type="checkbox"/> Not satisfactory	
19	Are emergency plans and recovery resources in place at all airports located near water for rescue of survivors in the water? .1 If yes, do these plans include both the airport authorities and RCCs?	<ul style="list-style-type: none"> • Review documented evidence 	<input type="checkbox"/> Satisfactory <input type="checkbox"/> Not satisfactory	
20	Do facilities that serve as alerting posts for receiving and responding to aeronautical and maritime distress information operate on a 24-hour basis?	<ul style="list-style-type: none"> • Review documented evidence 	<input type="checkbox"/> Satisfactory <input type="checkbox"/> Not satisfactory	
21	Has the State established procedures to be followed by RCCs and RSCs during emergency phases (uncertainty phase, alert phase and distress phase)?	<ul style="list-style-type: none"> • Review mechanism established to ensure effective implementation • Review RCC plans of operation 	<input type="checkbox"/> Satisfactory <input type="checkbox"/> Not satisfactory	
22	Does the State have a reliable 24-hour SAR Point of Contact (SPOC) for receiving, acknowledging and responding to GMDSS Alerts including Cospas-Sarsat distress beacon alerts?	<ul style="list-style-type: none"> • Review documented evidence 	<input type="checkbox"/> Satisfactory <input type="checkbox"/> Not satisfactory	

No	Question ¹	Action by Assessor ²	Evaluation ³	Remarks and Improvement Areas ⁴
23	Does each RCC or RSC have an operations manual which provides procedures and guidance material for handling all foreseeable SAR situations?	<ul style="list-style-type: none"> • Review documented evidence 	<input type="checkbox"/> Satisfactory <input type="checkbox"/> Not satisfactory	
24	Do RCC(s) and RSC(s) use international systems that assist SAR, e.g. Amver, Cospas-Sarsat, computer-assisted search planning?	<ul style="list-style-type: none"> • Review documented evidence 	<input type="checkbox"/> Satisfactory <input type="checkbox"/> Not satisfactory	
25	Can RCC(s) and RSC(s) monitor progress of a SAR response and adjust search planning if necessary?	<ul style="list-style-type: none"> • Review documented evidence 	<input type="checkbox"/> Satisfactory <input type="checkbox"/> Not satisfactory	
26	Are there established procedures to be followed by RCCs and RSCs in case of termination and suspension of the search and rescue operations?	<ul style="list-style-type: none"> • Review mechanism established to ensure effective implementation • Review RCC plans of operation 	<input type="checkbox"/> Satisfactory <input type="checkbox"/> Not satisfactory	
27	<p>Are there arrangements for the rapid use of SAR units and other available facilities to assist any aircraft or vessels or their occupants that are, or appear to be, in a state of emergency?</p> <p>.1 Are SAR units available that are capable of responding to all locations within the State's SRR(s)? Do SAR units carry IAMSAR Volume III?</p>	<ul style="list-style-type: none"> • Review documented evidence 	<input type="checkbox"/> Satisfactory <input type="checkbox"/> Not satisfactory	

No	Question ¹	Action by Assessor ²	Evaluation ³	Remarks and Improvement Areas ⁴
28a	<p>Are there SAR aircraft available which are equipped to:</p> <p>.1 communicate with other SAR units on scene, including marine units for overwater operations?</p> <p>.2 home on distress frequencies?</p> <p>.3 deliver SAR supplies whilst airborne, such as, for example, liferafts and SAR datum buoys?</p> <p>.4 retrieve survivors including medical evacuations?</p>	<ul style="list-style-type: none"> Review documented evidence 	<input type="checkbox"/> Satisfactory <input type="checkbox"/> Not satisfactory	
28b	<p>Are there marine SAR craft available which are equipped to:</p> <p>.1 communicate with other SAR units on scene, including aircraft?</p> <p>.2 home on distress frequencies?</p> <p>.3 deliver SAR supplies example SAR datum buoys?</p> <p>.4 retrieve survivors including medical evacuations?</p>		<input type="checkbox"/> Satisfactory <input type="checkbox"/> Not satisfactory	
29	<p>Does each RCC and RSC have full information about the capabilities (range, number of persons they could rescue, alert status, launch authority point of contact, etc.) for all the primary rescue units in their area of responsibility?</p>	<ul style="list-style-type: none"> Review documented evidence 	<input type="checkbox"/> Satisfactory <input type="checkbox"/> Not satisfactory	

No	Question ¹	Action by Assessor ²	Evaluation ³	Remarks and Improvement Areas ⁴
30	Can RCC(s) or RSC(s) request the deployment of all primary SAR units? .1 If not, does the coordination for use of SAR resources take place in a timely manner?	<ul style="list-style-type: none"> • Review documented evidence 	<input type="checkbox"/> Satisfactory <input type="checkbox"/> Not satisfactory	
31	Have voluntary SAR resources, including privately owned aircraft and boats, fishing vessels, industry-owned helicopters and boats and professional organizations been organized?	<ul style="list-style-type: none"> • Review documented evidence 	<input type="checkbox"/> Satisfactory <input type="checkbox"/> Not satisfactory	
32	Do RCCs and RSCs operation manuals include guidance on use of voluntary SAR resources?	<ul style="list-style-type: none"> • Review documented evidence 	<input type="checkbox"/> Satisfactory <input type="checkbox"/> Not satisfactory	
33	Do SAR units have special equipment for medical evacuations with trained personnel?	<ul style="list-style-type: none"> • Review documented evidence 	<input type="checkbox"/> Satisfactory <input type="checkbox"/> Not satisfactory	
34	Do SAR services cooperate with those responsible for investigating accidents and with those responsible for the care of those who suffered from the accident?	<ul style="list-style-type: none"> • Review documented evidence 	<input type="checkbox"/> Satisfactory <input type="checkbox"/> Not satisfactory	

Chapter 3 – Training, qualification, certification and exercises

No	Question ¹	Action by Assessor ²	Evaluation ³	Remarks and Improvement Areas ⁴
35	Does each RCC and RSC employ a sufficient workforce skilled in coordination and operational functions?	<ul style="list-style-type: none"> • Review mechanism established to ensure effective implementation • Review documented evidence 	<input type="checkbox"/> Satisfactory <input type="checkbox"/> Not satisfactory	
36	Does the State ensure that each RCC and, if appropriate, RSC, have written job descriptions for each of their staff?	<ul style="list-style-type: none"> • Review mechanism established to ensure effective implementation • Review job descriptions and confirm rational application 	<input type="checkbox"/> Satisfactory <input type="checkbox"/> Not satisfactory	
37	Does each RCC and, if appropriate, RSC, have an established training programme for their staff which includes regular appropriate SAR exercises? .1 Are training records or files maintained for all RCC staff?	<ul style="list-style-type: none"> • Review mechanism established to ensure effective implementation • Review documented training programme and verify if it includes, when applicable, initial, recurrent or specialized training • Review training schedule, SAR training syllabus, lesson plans 	<input type="checkbox"/> Satisfactory <input type="checkbox"/> Not satisfactory	

No	Question ¹	Action by Assessor ²	Evaluation ³	Remarks and Improvement Areas ⁴
38	<p>Do RCCs or RSCs have trained staff member to do the following:</p> <ul style="list-style-type: none"> .1 Carry out RCC communications and coordination functions? .2 Recognize the stages and phases of a SAR mission? .3 Determine search datum, search areas, and probability of success? .4 Account for aerospace and ocean drift? .5 Develop search action plans and rescue action plans? .6 Allocate and debrief resources? .7 Arrange air escorts, ships and other assistance for aircraft situations involving potential ditching? .8 Carry out international SAR obligations? 	<ul style="list-style-type: none"> • Review mechanism established to ensure effective implementation • Review documented evidence 	<ul style="list-style-type: none"> <input type="checkbox"/> Satisfactory <input type="checkbox"/> Not satisfactory 	

No	Question ¹	Action by Assessor ²	Evaluation ³	Remarks and Improvement Areas ⁴
39	<p>Does the State provide for regular training of its SAR system personnel and arrange appropriate SAR exercises?</p> <p>.1 Do crews of primary SAR units participate in regular SAR-related training or exercises?</p> <p>.2 Is there a formal planning and evaluation process for these exercises?</p> <p>.3 Do RCCs or RSCs carry out exercises involving other RCCs and RSCs and SAR units on a regular basis?</p> <p>.4 Does each element in the SAR organization regularly evaluate its staff training status and take steps to correct all identified training needs?</p>	<ul style="list-style-type: none"> • Review mechanism established to ensure effective implementation • Review documented evidence 	<input type="checkbox"/> Satisfactory <input type="checkbox"/> Not satisfactory	

Chapter 4 – Communications

No	Question ¹	Action by Assessor ²	Evaluation ³	Remarks and Improvement Areas ⁴
40	Do the RCC(s) and RSC(s) have rapid and reliable 24-hour means for communications with: .1 Other RCCs and RSCs? .2 Other civil/military agencies or facilities which support the SAR system such as Air Traffic Services units, Coast Radio Stations, SRUs, meteorology office, Cospas-Sarsat Mission Control Centre, alerting posts and other national emergency agencies and facilities?	<ul style="list-style-type: none"> • Review mechanism established to ensure effective implementation • Review documented evidence 	<input type="checkbox"/> Satisfactory <input type="checkbox"/> Not satisfactory	
41	Does the national communications system provide full coverage of the State and rapid, reliable 24-hour service?	<ul style="list-style-type: none"> • Review documented evidence 	<input type="checkbox"/> Satisfactory <input type="checkbox"/> Not satisfactory	
42	Do RCC(s) and RSC(s) have reliable radio communications capabilities covering their entire area(s) of responsibility for working with ships, aircraft and SAR units?	<ul style="list-style-type: none"> • Review documented evidence 	<input type="checkbox"/> Satisfactory <input type="checkbox"/> Not satisfactory	
43	Do RCC(s) or RSC(s) use satellite communications?	<ul style="list-style-type: none"> • Review documented evidence 	<input type="checkbox"/> Satisfactory <input type="checkbox"/> Not satisfactory	
44	Do RCC(s) and RSC(s) have reliable internet access?	<ul style="list-style-type: none"> • Review documented evidence 	<input type="checkbox"/> Satisfactory <input type="checkbox"/> Not satisfactory	

No	Question ¹	Action by Assessor ²	Evaluation ³	Remarks and Improvement Areas ⁴
45	Are RCC personnel involved in the conduct of external communications, including voice, reading and writing, proficient in the use of the English language?	<ul style="list-style-type: none"> • Review documented evidence 	<input type="checkbox"/> Satisfactory <input type="checkbox"/> Not satisfactory	
46	Which categories of aircraft and ships registered in the State are required to carry 406 MHz distress beacons?	<ul style="list-style-type: none"> • Review documented evidence 	<input type="checkbox"/> Satisfactory <input type="checkbox"/> Not satisfactory	
47	Are 406 MHz beacon registrations maintained in a database? .1 Is the database maintained for ELT, EPIRB and PLB 406 MHz distress beacons? .2 Is that database available on a 24-hour basis to SAR authorities?	<ul style="list-style-type: none"> • Review documented evidence 	<input type="checkbox"/> Satisfactory <input type="checkbox"/> Not satisfactory	
48	Has the State made arrangements for immediate distribution from the State's Cospas-Sarsat SPOC to the proper authorities for ELT, EPIRB and PLB distress beacon alerts?	<ul style="list-style-type: none"> • Review documented evidence 	<input type="checkbox"/> Satisfactory <input type="checkbox"/> Not satisfactory	
49	Is the Aeronautical Fixed Telecommunication Network (AFTN) or Aeronautical Fixed Network (AFN) co-located or readily accessible to the RCC(s) and RSC(s) 24-hours a day?	<ul style="list-style-type: none"> • Review documented evidence 	<input type="checkbox"/> Satisfactory <input type="checkbox"/> Not satisfactory	
50	Is the State implementing the provisions of the IMO Global Maritime Distress and Safety System (GMDSS)?	<ul style="list-style-type: none"> • Review documented evidence 	<input type="checkbox"/> Satisfactory <input type="checkbox"/> Not satisfactory	

No	Question ¹	Action by Assessor ²	Evaluation ³	Remarks and Improvement Areas ⁴
51	Do the RCC and RSC operations manuals include procedures for establishing communications with civil ships and aircraft?	<ul style="list-style-type: none"> • Review documented evidence 	<input type="checkbox"/> Satisfactory <input type="checkbox"/> Not satisfactory	
52	Do RCC(s) and RSC(s) have rapid access to aircraft and vessel tracking data to: <ul style="list-style-type: none"> .1 identify potential aircraft and vessels to divert to assist with a SAR response? .2 monitor the progress of SRUs during SAR missions? .3 provide historical tracking data on aircraft and vessels in distress? 	<ul style="list-style-type: none"> • Review documented evidence 	<input type="checkbox"/> Satisfactory <input type="checkbox"/> Not satisfactory	
53	Do ships and aircraft that are used for SAR have communications and electronic direction-finding capabilities covering all frequencies likely to be used?	<ul style="list-style-type: none"> • Review documented evidence 	<input type="checkbox"/> Satisfactory <input type="checkbox"/> Not satisfactory	
54	Do ships and aircraft that are used for SAR have accurate navigation systems?	<ul style="list-style-type: none"> • Review documented evidence 	<input type="checkbox"/> Satisfactory <input type="checkbox"/> Not satisfactory	
55	What means are used to notify RCC(s) or RSC(s) of a distress?	<ul style="list-style-type: none"> • Review documented evidence 	<input type="checkbox"/> Satisfactory <input type="checkbox"/> Not satisfactory	
56	What means are used to alert and inform SAR units of a distress, and to brief them to respond?	<ul style="list-style-type: none"> • Review documented evidence 	<input type="checkbox"/> Satisfactory <input type="checkbox"/> Not satisfactory	
57	Do all SAR units have mutually compatible communications?	<ul style="list-style-type: none"> • Review documented evidence 	<input type="checkbox"/> Satisfactory <input type="checkbox"/> Not satisfactory	

No	Question ¹	Action by Assessor ²	Evaluation ³	Remarks and Improvement Areas ⁴
58	<p>Is the State planning to improve communications or direction-finding/locating capabilities in any of the following areas?</p> <p>.1 Medium frequency (MF) .2 High frequency (HF) .3 VHF-FM .4 VHF-AM .5 UHF .6 Telephone, including mobile telephone .7 Satellite systems including tracking systems</p>	<ul style="list-style-type: none"> • Review mechanism established to ensure effective implementation • Review documented evidence 	<p><input type="checkbox"/> Satisfactory <input type="checkbox"/> Not satisfactory</p>	
59	<p>Do RCC(s) and RSC(s) have procedures for providing timely and competent medical assistance and advice to ships and other vessels at sea?</p>	<ul style="list-style-type: none"> • Review mechanism established to ensure effective implementation • Review documented evidence 	<p><input type="checkbox"/> Satisfactory <input type="checkbox"/> Not satisfactory</p>	

Chapter 5 – System Management

No	Question ¹	Action by Assessor ²	Evaluation ³	Remarks and Improvement Areas ⁴
60	<p>Which national agencies or organizations are responsible for:</p> <ul style="list-style-type: none"> .1 Aircraft registration and safety? .2 Air traffic services and safety? .3 Investigation of aviation accidents and incidents? .4 Maritime vessel registration and safety? .5 Investigation of maritime accidents and incidents? .6 Regulation and enforcement of radio frequency usage? .7 Serving as the national SAR Point Of Contact (SPOC) for receipt of Cospas-Sarsat alert data? .8 Personal Locator Beacon usage and alerts? .9 Satellite Emergency Notification Devices (SENDs) usage and alerts? .10 Land based SAR? .11 Managing national civil emergencies? .12 National defence? .13 Providing paid SAR resources? .14 Providing volunteer SAR resources? .15 State law enforcement? .16 Emergency medical advice and care? .17 Medical evacuations? .18 Supporting participation by ships in ship reporting systems, such as the Automated Mutual- assistance Vessel Rescue (Amver) system? .19 Liaison with SAR related international organizations including ICAO, IMO and Cospas-Sarsat? 	<ul style="list-style-type: none"> • Review mechanism established to ensure effective implementation • Review documented evidence 	<ul style="list-style-type: none"> <input type="checkbox"/> Satisfactory <input type="checkbox"/> Not satisfactory 	

No	Question ¹	Action by Assessor ²	Evaluation ³	Remarks and Improvement Areas ⁴
61	Has the State designated as SAR units elements of public or private services suitably located and equipped for SAR operations?	<ul style="list-style-type: none"> • Review mechanism established to ensure effective implementation • Review documented evidence 	<input type="checkbox"/> Satisfactory <input type="checkbox"/> Not satisfactory	
62	Does the State coordinate its SAR organization with those of neighbouring States?	<ul style="list-style-type: none"> • Review documented evidence of the establishment of the agreements concerning search and rescue among neighbouring States 	<input type="checkbox"/> Satisfactory <input type="checkbox"/> Not satisfactory	
63	Has each RCC in the State prepared detailed plans of operation for the conduct of SAR operations within its SRR?	<ul style="list-style-type: none"> • Review documented evidence 	<input type="checkbox"/> Satisfactory <input type="checkbox"/> Not satisfactory	
64	Does the State have formal SAR agreements for inter-agency coordination and for cooperation with neighbouring countries?	<ul style="list-style-type: none"> • Review documented evidence 	<input type="checkbox"/> Satisfactory <input type="checkbox"/> Not satisfactory	
65	Do RCC(s) and RSC(s) have procedures for coordinating with hospitals to receive all personnel evacuated due to medical emergencies?	<ul style="list-style-type: none"> • Review documented evidence 	<input type="checkbox"/> Satisfactory <input type="checkbox"/> Not satisfactory	
66	Have formal procedures been developed for providing medical assistance and advice and for making medical evacuation decisions?	<ul style="list-style-type: none"> • Review documented evidence 	<input type="checkbox"/> Satisfactory <input type="checkbox"/> Not satisfactory	

No	Question ¹	Action by Assessor ²	Evaluation ³	Remarks and Improvement Areas ⁴
67	Are there contingency plans in place for the continuation of SAR services in the event of the temporary unavailability of your RCC(s) and RSC(s), for example during RCC/RSC emergency evacuations, system outages or natural disasters?	<ul style="list-style-type: none"> • Review documented evidence 	<input type="checkbox"/> Satisfactory <input type="checkbox"/> Not satisfactory	
68	Does the State permit, subject to such conditions as may be prescribed by its own authorities, entry into its territory of SAR units of other States for the purpose of searching for, and the rescue of, survivors of aviation and maritime incidents and accidents?	<ul style="list-style-type: none"> • Review documented evidence 	<input type="checkbox"/> Satisfactory <input type="checkbox"/> Not satisfactory	
69	Does the State authorize its RCCs to provide, when requested, assistance to other States' RCCs, including assistance in the form of aircraft, vessels, or equipment?	<ul style="list-style-type: none"> • Review documented evidence 	<input type="checkbox"/> Satisfactory <input type="checkbox"/> Not satisfactory	
70	Has the State arranged for aircraft, vessels, local services and facilities which do not form part of the SAR organization to cooperate fully with the latter in SAR and to extend any possible assistance to the survivors of aviation and maritime accidents?	<ul style="list-style-type: none"> • Review documented evidence 	<input type="checkbox"/> Satisfactory <input type="checkbox"/> Not satisfactory	
71	Does each RCC have an established management plan for dealing with the media during SAR events?	<ul style="list-style-type: none"> • Review documented evidence 	<input type="checkbox"/> Satisfactory <input type="checkbox"/> Not satisfactory	

No	Question ¹	Action by Assessor ²	Evaluation ³	Remarks and Improvement Areas ⁴
72	Does the State send delegates to participate directly in meetings of ICAO and IMO that deal with SAR issues?	<ul style="list-style-type: none"> • Review documented evidence 	<input type="checkbox"/> Satisfactory <input type="checkbox"/> Not satisfactory	
73	How do SAR managers stay informed on decisions, and outcomes of meetings conducted by ICAO and IMO?	<ul style="list-style-type: none"> • Review documented evidence 	<input type="checkbox"/> Satisfactory <input type="checkbox"/> Not satisfactory	

Chapter 6 – Improving services

No	Question ¹	Action by Assessor ²	Evaluation ³	Remarks and Improvement Areas ⁴
74	<p>Is there a system in place for safety management and the continuous improvement of the State SAR system?</p> <p>.1 Is there a quality management system in place for the State's SAR services which includes a system with time frame for elimination of deficiencies identified?</p> <p>.2 Is there a safety management system in place for RCC/SAR operations?</p> <p>.3 Do the State's RCCs use a risk assessment process for SAR operations?</p>	<ul style="list-style-type: none"> • Review documented evidence • Confirm inspection procedures and inspection reports • Confirm mechanism/system with time frame for elimination of deficiencies identified. • Review list of deficiencies which have been identified by inspection and remedial action planned/taken 	<input type="checkbox"/> Satisfactory <input type="checkbox"/> Not satisfactory	
75	<p>Does the State maintain a statistical database on SAR events which assist with analysis of operational performance of RCCs/RSCs and the SAR system?</p>	<ul style="list-style-type: none"> • Review documented evidence 	<input type="checkbox"/> Satisfactory <input type="checkbox"/> Not satisfactory	
76	<p>Are debriefings of SAR operations conducted and are any lessons learned shared with others in the SAR system?</p>	<ul style="list-style-type: none"> • Review documented evidence 	<input type="checkbox"/> Satisfactory <input type="checkbox"/> Not satisfactory	
77	<p>Are complete records (sufficient to reconstruct the incident) maintained for all SAR events?</p>	<ul style="list-style-type: none"> • Review documented evidence 	<input type="checkbox"/> Satisfactory <input type="checkbox"/> Not satisfactory	

No	Question ¹	Action by Assessor ²	Evaluation ³	Remarks and Improvement Areas ⁴
78	Are SAR case records used to analyze and improve the SAR system?	<ul style="list-style-type: none"> • Review documented evidence 	<input type="checkbox"/> Satisfactory <input type="checkbox"/> Not satisfactory	
79	Do SAR case records satisfy legal requirements?	<ul style="list-style-type: none"> • Review documented evidence 	<input type="checkbox"/> Satisfactory <input type="checkbox"/> Not satisfactory	

Appendix M

National Responsibilities of Contracting States under international conventions

M.1 Aviation arrangements

M.1.1 The Convention on International Civil Aviation (Chicago Convention) provides a basis for international cooperation between Contracting States in the provision of international civil aviation SAR services. The Chapters, Articles and Annexes detail certain principles and arrangements in order that international civil aviation services may be developed in a safe and orderly manner, international air transport established on the basis of equality of opportunity and all such services operated soundly and economically. These apply to international aviation operations but they also typically form the basis for national arrangements that only apply within the national territory (land and territorial sea). RCCs should have procedures in place with their counterpart civil aviation authorities for advice regarding these aviation arrangements, if required.

M.1.2 The Convention Articles include the following:

Articles specific to search and rescue and aircraft emergencies are as follows:

Articles 1 and 2	Airspace and Sovereignty;
Article 12	Rules and Regulations;
Article 25	Search and Rescue;
Article 26	Accident and Incident Investigation;
Article 28	Air Navigation Facilities;
Article 31	Certificate of Airworthiness;
Article 32	Licences of Personnel; and
Article 68	Designation of Routes and Airports.

M.1.3 Details of the Articles are elaborated in Annexes to the Convention.

The Annexes that have a bearing on emergency situations involving aircraft are the following:

Annex 2	Rules of the Air;
Annex 3	Meteorological Services;
Annex 6	Operation of aircraft (commercial air transport and general aviation) and helicopters (details include ELT types and carriage requirements);
Annex 10	Communications (Volume III includes ELT specifications);
Annex 11	Air Traffic Services (including the responsibilities for search and rescue alerting and in-flight emergency response);

Annex 12	Search and Rescue;
Annex 13	Aircraft Accident Investigation;
Annex 14	Aerodrome and Heliport Design and Operations (including emergency planning with the RCC); and
Annex 17	Security and Unlawful Interference.

M.1.4 It should be noted that the Chicago Convention does not provide any minimum response standards or sanctions in relation to the non-provision of aviation search and rescue services but relies on Contracting States to provide a level of service commensurate with their perceived requirements and available resources. There is also an assumption that neighbouring countries will work together to achieve the common good.

M.2 Maritime arrangements

M.2.1 The International Convention for the Safety of Life at Sea (SOLAS) is generally regarded as the most important of all international treaties concerning the safety of merchant ships. Its first version was adopted in 1914. Chapters with specific information relevant to SAR include:

Chapter I – General Provisions Part A discusses the application of the SOLAS Convention and provides some key definitions. Unless expressly provided otherwise within SOLAS, it applies only to ships engaged on international voyages. The classes of ships to which each chapter applies are more precisely defined in each chapter. The SOLAS Convention applies to ships and may not apply to the term "vessels" which has a different meaning under IMO regulations.

Chapter III – Life-saving appliances and arrangements discusses lifeboats, liferafts and rescue boats. Passenger ships and cargo ships often do not have the same requirements. Regulation 6, *Communications*, discusses SAR locating devices which may be carried on survival craft.

Chapter IV – Radiocommunications covers all forms of maritime communications (to include SAR alerting, coordinating, locating signals) and is the basis for IMO's Global Maritime Distress and Safety System (GMDSS). Part B is *Undertakings by Contracting Governments* and Part C is *Ship requirements*.

Chapter V – Safety of Navigation, with certain exceptions listed, applies to all ships on all voyages. "All ships" is defined to mean any ship, vessel or craft irrespective of type and purpose. State vessels are one of the exceptions but it is a common practice by many States to have their ships meet the intent of the SOLAS Convention. Regulation 2 defines search and rescue service. Other regulations of particular interest to SAR include regulation 7 *Search and rescue services*, regulation 19-1 *Long-range identification and tracking of ships* (information is free of charge for SAR services of Contracting Governments), regulation 21, *International Code of Signals and IAMSAR Manual*, and regulation 33, *Distress situations: obligations and procedures* (for the master of a ship at sea and also Contracting Governments).

Chapter XIV – Safety measures for ships operating in polar waters makes mandatory the International Code for Ships Operating in Polar Waters (the Polar Code). The Polar Code requires the ship to have a Polar Water Operational Manual, and, its chapter 10 – Communication has information relevant to SAR.

- M.2.2** The International Convention on Maritime Search and Rescue, 1979, known as the SAR Convention 1979, is designed to provide a framework for carrying out search and rescue operations following accidents at sea.
- M.2.3** The SAR Convention, as amended, clarifies the responsibilities of Governments and puts emphasis on the regional organizational approach and coordination between maritime and aeronautical operations.
- M.2.4** Articles I to VIII of the SAR Convention discuss the general obligations of Parties under the Convention, and the obligations or rights of vessels provided for in other international instruments.
- M.2.5** The chapters and resolutions that have a bearing on the management of emergency incidents involving persons in distress at sea include the following:

- | | |
|------------------|--|
| Chapter 1 | Terms and definitions used |
| Chapter 2 | Organization and coordination of Search and Rescue services; |
| Chapter 3 | Cooperation between States; |
| Chapter 4 | Overview of Rescue Coordination Centre and Rescue Sub-Centre operating procedures; and |
| Chapter 5 | Operational requirements of ship reporting systems |

Appendix N

Sample contract between RCC and TMAs

- Amend Appendix N as follows:

[...]

3.2.1 Ships seeking medical advice will normally be put in contact with one of the maritime communications stations. Calls will then either be transferred or relayed to the TMAS. Requests for advice may therefore come to the TMAS:

- .1 directly from a ship via a transferred telephone call;
- .2 via a maritime communications station which has received a request for assistance from a ship by:
 - .1 radiotelephony (RTF);
 - .2 radio telex;
 - .3 fax/phone;
 - .4 ~~Inmarsat~~ IMO recognized mobile satellite service;
 - .5 email; or
 - .6 via the RCC

New Appendix O

- Add new appendix O as follows:
-

Sample template for a joint search and rescue exercise

O.1 Objectives

State the objectives of the joint SAREX and what participants want to achieve from it. SAREX can be in different formats; for example, Table Top SAREX which involves discussion and assists in understanding and testing of a plan, Simulation SAREX where simulators are used to create realism without physically deploying assets, Live or Full Scale SAREX where there is actual deployment of assets to create realism in the testing of the plan, and Command Post SAREX where the decision-making process is tested.

For example:

O.1.1 The objectives of the joint SAREX are:

- a) To provide improved search and rescue (SAR) cooperation between (participating agencies or State RCC) and (participating agencies or State RCC).
- b) To provide continuation training for personnel of SAR organizations from (participating agencies or State RCC) and (participating agencies or State RCC).
- c) To test the communication facilities and procedures between (participating agencies or State RCC) and (participating agencies or State RCC).; and
- d) To test and determine the effectiveness of the Search and Rescue Units (SRUs) of (participating agencies).

O.2 Date and timing of SAREX

State the agreed date and time for the joint SAREX. Have alternate or contingency plans in the event that a full scale SAREX cannot be conducted due to bad weather or any unforeseen circumstances. It is recommended that a pre-SAREX brief be conducted to ensure all participants understand their roles and the required actions to be taken. State the agreed time for a pre-SAREX brief to be carried out for all participants. States may conduct simultaneous pre-SAREX briefings at their own locations for their local participants. For standardization and to avoid confusion, it is recommended that all timing and dates used should be in UTC as there may be a difference in time and day for different States. After the SAREX, it is also recommended to conduct a de-brief for all participants.

For example:

O.2.1 Table Top SAREX or A Full Scale Exercise will be held between (participating agencies or State) and (participating agencies or State) on(day of the week, date/month/year) from (time in UTC) to (time in UTC).

O.2.2 In the event of bad weather, the Full Scale SAREX will be converted into a Table Top SAREX. The cut off time will be at (time in UTC).

O.2.3 A Pre-SAREX brief will be held on (day of the week, day/month/year) in (location of the pre-SAREX brief) commencing at (time in UTC).

O.2.4 A Post-SAREX de-Brief will be held on (day of the week, day/month/year) in (location of the de-brief) commencing at (time in UTC).

O.3 SCENARIO

Discussion and development of exercise scenario with participating State or States and agencies involved. Scenario created should be as realistic as possible to simulate a real incident. A fictitious flight plan or ship's passage plan can be included to provide additional information pertaining to the distressed aircraft/ship. Using fictitious names and/or callsigns for the distressed aircraft/ship and its airline/operator will avoid confusion on, for example, social media. Provide a fictitious manifest to indicate the number of people at risk.

For example:

O.3.1 At (time in UTC), a(type of aircraft/ship), (name/callsign of distressed aircraft/ship), departed from (point of departure) to (destination) with (persons on board). At (time in UTC), aircraft/ship declared "MAYDAY" due to (nature of emergency) at (location in Lat and Long or with reference to a prominent location known to all).(further details of the scenario, as required).

O.3.2 Other information, for example Pilot-in-command/Master's actions, equipment carried on board, description of aircraft/ship, etc.

O.4 Participating Organizations

Identify and list all participating agencies. As many responding agencies as possible should be included, both government and private. Air Navigation Service Provider, Aircraft Investigation Bureau, airlines, shipping companies, harbour authorities, etc. should be involved in a SAREX, as they would be directly involved in any real incident.

For example:

O.4.1 From (State: list participating local agencies, for example, RCC, Civil Aviation Authority, Air Force, Navy, etc.)

- 1)
- 2)
- 3)
- 4)
- 5)

From (State: list participating local agencies):

- 1)
- 2)
- 3)
- 5)
- 6)

O.5 **Deployment of exercise search and rescue facilities and callsigns**

State all the SAR facilities that will take part in the SAREX. It is recommended that SRU callsigns should be pre-fixed with the word "SAREX" to indicate that it is an exercise aircraft or surface vessel. This will help avoid confusion between a SAREX and a real incident. A callsign assigned to a particular SAR facility should not be changed and should be used throughout the exercise. Each SRU should have a unique callsign.

For example:

O.5.1 SRUs from (participating State) and their callsigns are as follows:

<u>Type of SRUs</u>	<u>Callsign</u>	<u>Remarks</u>
Fokker 50	SAREX 01	Search
C130	SAREX 02	Search
Dolphin Helicopter	SAREX 03	Search and Rescue
.....	SAREX.....
.....	SAREX.....
.....	SAREX.....

O.5.2 SRUs from (participating State) and their callsigns are as follows:

<u>Type of SRUs</u>	<u>Callsign</u>	<u>Remarks</u>
(Helicopter)	SAREX 04	Search and Rescue
(Ship)	SAREX 05	Search and Rescue
.....	SAREX....

O.6 Communications

State the agreed radio frequencies and other communications facilities to be used in the SAREX. List communication arrangements between the RCCs involved and between the RCCs and the SRUs and other mobile SAR facilities. It is recommended that a communication check be conducted between all parties before the SAREX to ensure serviceability of communication equipment. A standby day may be necessary if the communication check is not satisfactory.

For example:

O.6.1 The communications arrangement will be as follows:

a) Between (participating agency or State RCC) and (other agencies or participating State RCC)

Primary communication (radio frequencies, telephone numbers, etc.)

Secondary communication -

Standby communication -

b) Between (State RCC and SRUs)

Primary communication -kHz orMHz

Secondary communication kHz orMHz

Standby communication -kHz orMHz

O.6.2 A communication test between (participating agency or State RCC) and (the other participating agencies or State RCC) will be conducted prior to the SAREX. The test will be conducted on (day of the week, date/month/year) from (time in UTC) to (time in UTC).

O.6.3 In the case of an unsatisfactory communication test, another test will be conducted on (day of the week, date/month/year) from (time in UTC) to (time in UTC).

0.6.4 All messages pertaining to the exercise shall be prefixed and ended with the words "EXERCISE EXERCISE EXERCISE". Exercise participants **must not** use any internationally recognized Distress or Urgency Procedure words (for example, "Mayday", "Pan Pan") on radio or telephone systems. Radio communications procedure words should be replaced as follows:

Mayday - replace with "Mike Delta"

Pan Pan - replace with "Papa, Papa"

Securité - replace with "Sierra, Sierra"

This will help to avoid confusion between a SAREX and an actual SAR incident.

0.7 Search object

In a Full Scale SAREX, States should consider the deployment of a search object (including a locator beacon) to add realism to the exercise. This will enable participating SRUs to practice visual and/or electronic search techniques. The search object can be deployed at the proposed distress location at the SAREX start time. Search objects should be clearly marked as being deployed for exercise purposes.

For example:

7.1 A (description of the search object) will be provided by (one of the participating agencies) and will be deployed at (time in UTC) on(date of the SAREX) at the distress position.

7.2 The search target is marked with..... (for example, the word "SAREX").

8 Alerting and activation

State clearly the alert and activation processes for the SAREX, including which agency will initiate the distress phase and how the other participating agencies will be notified. In a joint SAREX, if the distress location is within the area of responsibility of a particular State, the State concerned should initiate the alerting and activation phase.

For example:

8.1 Since the distress location is within the area of responsibility of (State), (name) RCC will notify (participating agencies) to initiate joint SAR operations.

9 Search area

Discuss how to determine the search area and which RCC will do so. In a joint SAR effort, the RCCs involved can determine their own search areas and agree an overall area.

For example:

9.1 The respective SAR Mission Coordinators (SMCs) will work out a search area upon receipt of the distress location.

9.2 The SMCs shall discuss with each other and agree on a common search area.

9.3 If there is a great difference between the two search areas, the coordinating RCC shall decide on the most probable area and take the necessary action to promulgate the area as a restricted area for SAR operations accordingly.

10 Diplomatic clearance

In a joint SAREX, make necessary arrangements for applying for diplomatic clearance if State assets may be or are required to enter another State's territorial airspace or waters. The application process should be made known to all relevant participating agencies. If there is an agreement in place between participating States, then the agreed procedure should be followed. Provide information regarding the SRUs and particulars of the personnel on board. It is recommended that particulars of the SRUs be provided to the State(s) concerned prior to the SAREX. This will assist in the diplomatic clearance process.

For example:

10.1 (State) RCC will send a request to (State) for diplomatic clearance to allow (State's) SRUs to enter (State's) territorial airspace/waters.

10.2 To obtain diplomatic clearance the RCC shall provide the following particulars:

- a)** unique identifier of the SRU as required by local authorities;
- b)** type of aircraft or vessel;
- c)** name of Pilot in Command/Master;
- d)** names of crew on board (not required for sea asset);
- e)** area of operation; and
- f)** date and time of operation.

10.3 The details of the SRUs concerned shall be provided (days/weeks) before the exercise. Application for diplomatic clearances should be made through the normal channels in order to accelerate the diplomatic clearance process.

11 Search operations

Ensure the safe conduct of the SAREX, especially as regards the air assets. It is recommended that there should be one coordinating RCC providing instructions to SRUs prior to entering the search area. It is also recommended that an Aircraft Coordinator be deployed to provide instructions to aircraft during transit to and from the search area as well as within the search area. Assign one of the SRUs as the On Scene Coordinator, coordinating all the SAR facilities in the search area as well as providing an important communication link with the distressed aircraft/ship.

For example:

11.1 All SRUs shall report to the coordinating RCC or On Scene Coordinator prior to entering the search area and while conducting SAR operations in the search area to ensure safety and efficiency in the joint SAR effort. All aircraft involved must adhere to ATC instructions.

11.2 Non-exercise aircraft/surface vessels shall keep clear of the search area unless clearance has been obtained for them to transit through.

12 Rescue operations

Discuss how the rescue operation is to be executed. Live rescue operations provide training and testing opportunities. If personnel are deployed at the scene to simulate a rescue operation, it is recommended to have a safety boat in the vicinity to ensure that the operation is closely monitored and all safety procedures are adhered to. Each SRU will report to the coordinating RCC or On Scene Coordinator the number of survivors rescued and the state the survivors are in. This will assist in accounting for all at risk and whether immediate evacuation is required. If possible, recover the search object after the exercise: this will help avoid unnecessary subsequent SAR action. If recovery is not possible, make general broadcasts to warn of the object's location.

For example:

12.1 When the search object is sighted, the SRU shall inform the coordinating RCC. The RCC will disseminate the information to all other participants.

12.2 Recovery of the search object after the exercise will be undertaken by (agency responsible for recovering the search object).

12.3 Recovery of the search object after the exercise will be undertaken by (agency responsible for recovering the search object).

12.4 If the search object cannot be recovered, urgent safety information broadcast action will be taken by (agency responsible).

13 Emergency landing of participating aircraft

In a joint SAREX, make arrangements for participating aircraft to land in the event of an emergency.

For example:

13.1 (State's) aircraft participating in the SAREX will be given permission to land at (name of airport or airfield) if an emergency landing is required.

14 Termination or suspension of SAREX

State how and under what circumstances the SAREX will terminate. Make response arrangements in the event of a real incident occurring during the SAREX. Agree a code word or words which will be understood by all participating agencies and units. Once the code word is broadcast the SAREX will be converted into real SAR operations, at least for the duration of the real emergency.

For example:

14.1 The SAREX will be terminated when:

- a) all the Search and Rescue Units have returned to base; or
- b) the time for the SAREX has expired and no search object has been sighted.

The SAREX may be terminated or temporarily suspended when there is an actual emergency.

14.2 In the case of a real emergency, the exercise will be converted into a real SAR operation. The code words "**NO DUFF NO DUFF**" will be broadcast. All participating agencies and units will cease the exercise immediately and await instructions from the coordinating RCC.

14.3 The exercise may be resumed when the real emergency has been resolved, if the participating agencies agree. Resumption of the exercise will be notified to all participants by the coordinating RCC. Alternatively the real emergency may require the exercise to be terminated.

15 SAREX de-brief

Conduct of a SAREX de-brief is important as this is where the evaluation process of the exercise is presented by evaluation experts who observed the exercise, together with observations by people who actually participated in the exercise scenarios. This is the final step to identify weaknesses and good practices and development of recommendations for improvement. Agree on a date and venue to conduct a SAREX de-brief including all exercise participants.

For example:

15.1 SAREX Debrief will be held on (day of the week, date/month/year) commencing at (time in UTC).

15.2 The venue for the SAREX De-brief will be (name the venue and give its address).

16 SAREX Controllers/Evaluators/Observers

Name the personnel who will be involved in the SAREX as observers, evaluators and exercise controllers. Evaluators and controllers in particular must have SAR expertise so that they will understand what is to be evaluated and how to control the exercise to maximize its value.

For example:

16.1 Personnel involved in the SAREX as exercise controllers, evaluators and observers will be as follows:

..... (Agency) (name and role in the exercise)

..... (Agency) (name and role in the exercise)

..... (Agency) (name and role in the exercise)

17 Invitation to Observers

Agencies or States may consider inviting observers from other agencies or foreign countries or international organizations to attend and observe the SAREX. These personnel can provide valuable feedback for improvement to the system. Agree which State will do the invitations and who should be invited to attend.

For example:

17.1 Invitations to observers to observe the SAREX will be provided by (agency providing the invitation). Observers will be positioned at (venue(s) for observation of the SAREX) and will be escorted by officers of (agency or agencies providing escorts).

17.2 The following countries and organizations will be invited to attend:

a) (name of country or organization)

b) (name of country or organization)

c) (name of country or organization)

d) (name of country or organization)

18 News media coverage

*If there is provision for news media coverage of the SAREX, agree the necessary arrangements (spokespeople, drafting of press releases, etc.). During a SAREX, it is recommended that a joint information centre be set up as this will ease the burden on RCCs. Updates by RCCs are provided to one source thus ensuring the provision of timely, clear, accurate and consistent reports to the news media. This will provide a training opportunity in dissemination of **information in a real incident**.*

For example:

18.1 Information updates will be provided by the RCC(s) to a Joint Information Centre for reports/updates/press releases to the news media.

18.2 The Joint Information Centre will be established and staffed by the following agencies:

..... (name of agency)

..... (name of agency)

..... (name of agency)

18.3 If there is a requirement for a joint press release on the SAREX to be issued,(agency that will produce the draft) will draft the press release and forward it to (other participating agencies, as agreed) for concurrence before it is issued.

19 SAREX report

A SAREX report is important as it will serve as a permanent record of the exercise. Each element of the exercise should be recorded and lessons learnt during the exercise captured. Agree who should produce the SAREX Report for dissemination to all participating agencies and other interested parties.

For example:

19.1 (Insert Agency or State) will produce the SAREX Report with assistance from (the other participating agencies or State(s)). Photographs will be made available for the SAREX report.

19.2 A copy of the report will be sent to each of the following participating agencies, countries and international organizations.

a) (agency or country or international organization)

b) (agency or country or international organization)

c) (agency or country or international organization)

20 Venue for the next SAREX

It is good to plan for an annual joint SAREX with relevant agencies and/or neighbouring States. State the date and venue if possible for the next SAREX coordination meeting and the proposed SAREX type and date.

For example:

20.1 The next SAREX Coordination Meeting will be held at (venue) on (date/month/year).

20.2 The next SAREX is scheduled to be held on (date/month/year). It is proposed that this SAREX will be a (type) exercise

AMENDMENTS TO IAMSAR MANUAL VOLUME II

Document control

Contents

2.6 406 MHz distress beacons, - EPIRBs, **ELT** and PLBs

6.16 Search and rescue within areas remote from SAR facilities

Renumber subsequent sections in Chapter 6

Appendix T Checklists and guides for multiple aircraft SAR operations

Appendix U Mobile telecommunications device location process

Abbreviation and acronyms

ADS-B automatic dependent surveillance – broadcast

ADT autonomous distress tracking

[...]

GADSS Global Aeronautical Distress and Safety System

[...]

Inmarsat an IMO recognized mobile satellite communication-service provider for the GMDSS

[...]

TCAS Traffic Collision Avoidance System

Glossary

Aircraft operator	ICAO Annex 12 — <i>Search and Rescue</i> , "A person, organization or enterprise engaged in or offering to engage in an aircraft operation." This means (i) a person or company who, for compensation or hire, participates in the carriage by air transport of persons or property, or other aerial-work services using aircraft; commonly an "airline" or other type of air transport or services company and (ii) a person who owns or shares ownership of a general aviation aircraft that is used by them but not for commercial air transport purposes.
Aircraft tracking	A process, established by the aircraft operator, that maintains and updates, at standardized intervals, a ground-based record of the four dimensional position (latitude, longitude, altitude and time stamp) of individual aircraft in flight (ICAO Annex 6).
Air traffic service	A generic term meaning variously, flight information service, alerting service, air traffic advisory service, air traffic control service (area control service, approach control service or aerodrome control service).
Air traffic services unit	A generic term meaning variously, air traffic control unit, flight information centre or air traffic services reporting office.

Autonomous distress tracking	The capability to transmit information from which the position of an aircraft in distress can be determined at least once every minute and which is resilient to failures of the aircraft's electrical power, navigation and communication systems. <i>Note: this capability is described under "Location of an Aeroplane in Distress" in ICAO Annex 6, Part 1.)</i>
Forward-looking airborne radar (FLAR)	Any aircraft-mounted radar designed to detect targets search objects ...
Forward-looking infrared (FLIR)	An imaging system, mounted on board surface vessels or aircraft, designed to detect thermal energy (heat) emitted by targets search objects ...
IMO recognized mobile satellite service	Distress and safety communication service provided by a mobile satellite service recognized by the International Maritime Organization (IMO), for use in the GMDSS.
Mobile-satellite service	A radiocommunication service between mobile earth stations and one or more space stations, or between space stations used by this service; or between mobile earth stations by means of one or more space stations.

Chapter 1 – The search and rescue system

[...]

1.3 SAR resource

[...]

1.3.10 The Global Aeronautical Distress and Safety System (GADSS) is a system of systems and procedures that will apply initially to certain commercial air transport operations under ICAO Annex 6, Part 1 applicability. It may also extend to other civil air transport operations. The aircraft operator is required to establish an aircraft tracking capability to track their aircraft throughout its area of operations. A separate and independent autonomous distress tracking (ADT) system also forms part of the GADSS.

The ADT function is applicable from 1 January 2021 for certain aircraft as described in 1.3.12.

1.3.11 Aircraft tracking is a core component of GADSS. The automated four-dimensional (latitude, longitude, altitude and time) position reporting is to occur at an interval of 15 minutes or less (recommended in all areas of operation and required in oceanic areas). The objective is to reduce the time necessary to resolve the status of an aircraft or, when necessary, help locate an aircraft. If the aircraft operator confirms that Air Traffic Services obtains an aircraft position at 15 minute intervals or less using ATS surveillance, then the aircraft operator does not need to independently track their aircraft for that part of the flight within ATS surveillance.

1.3.12 As of 1 January 2021, new aircraft with a take-off mass greater than 27,000 kilograms will be fitted with ADT capability. ADT is used to identify the location of an aircraft in distress with the aim of establishing, to a reasonable extent, the location of an accident site within a 6 NM radius. ADT uses onboard systems to broadcast the aircraft position (latitude and longitude), or distinctive distress signals from which the aircraft position and time can be derived. The aircraft position information will be transmitted, without the need for flight crew action, at least once every minute, when an aircraft is in a distress condition.

1.3.13 When it is identified that an aircraft is considered to be in a state of emergency, the RCC will be alerted. The alerting process envisaged in the GADSS is consistent with the current ATS alerting service provisions of ICAO Annex 11 — *Air Traffic Services* and Annex 12 — *Search and Rescue*.

- if an ATS unit detects a distress condition it will notify the RCC and the operator;
- if the operator detects a distress condition it will notify the ATS unit who will in turn notify the RCC;
- if an ELT is activated the RCC will be notified via the Cospas-Sarsat system;
- if the RCC receives the information from other sources, the RCC will identify to which emergency phase the situation corresponds and shall apply the procedures applicable to that phase.

1.3.14 The sharing of GADSS alerting information requires global coverage and a global interoperable systems approach. Aircraft tracking and ADT alert information for aircraft emergency conditions needs to be rapidly distributed to the aircraft operator, responsible ATS unit and the responsible RCC. Effective sharing of this information to the responsible stakeholders requires well defined, accurate and readily accessible global FIR and SRR data, plus reliable emergency 24-hour contact details for the aircraft operators, ATS units and RCCs.

[...]

1.4.5 Appendix D, MEDICO or MEDEVAC checklist provides additional information, including guidance when full medical consultation may not be available.

1.6 SAR operations stages

Initial action

1.6.6 Once an RCC receives an initial report about persons or craft in distress, some immediate action often is appropriate pending receipt and evaluation of more complete information. RCCs usually have in their plans of operation a checklist of steps to accomplish for each type of incident with which the RCC expects that it may become involved.

1.6.7 After evaluating all available information and taking into account the degree of emergency, the SMC should declare the appropriate emergency phase and immediately inform all appropriate centres, personnel and facilities. Three emergency phases have been established for classifying incidents and to help in determining the actions to be taken for each incident. These are:

- uncertainty phase;
- alert phase; and
- distress phase.

- 1.6.8** The response to the emergency will depend on many factors, including the nature of the emergency, on-scene conditions, the number of people at risk and their likely survival times, and the capability of available SAR facilities. The SMC should assess the information available and, consulting with the commander of the craft in difficulty if possible and other responders as appropriate, determine the best course of action.
- 1.6.9** Having assessed the situation and decided an initial course of action, the SMC should communicate it efficiently to all responders and, if possible, to those at risk.
- 1.6.10** Depending on how the situation develops, the incident may have to be reclassified and/or response action changed. See chapter 3 for a complete discussion of initial action stage and emergency phases of a SAR incident. Emergency phases are only intended to be declared by an RCC, an RSC, or an ATS unit.
- 1.8.11** [...] mass rescue operations, and in appendix O in IAMSAR Manual Volume I, *Organization and Management*, with a sample template for a joint search and rescue exercise.

[re-number subsequent paragraphs]

1.10 Public relations

[...]

- 1.10.5** When a major incident occurs, such as with a large aircraft or cruise ship, hundreds of persons may be at risk, involving many nationalities. Such an incident may result in the need for mass rescue operations (MROs), which are discussed in chapter 6. In this situation, the RCC could become the focus of world attention. Such events will undoubtedly require the involvement of other emergency service providers and a concerted effort will be required by the RCC if a consistent and controlled message to the public is to be maintained. Actions by the RCC may include the following:
- request representatives from ~~involved emergency service providers~~ responding organizations (including the aircraft or ship operator, as appropriate) to help staff a joint media relations team;
 - select a spokesperson(s);
 - issue a regular press releases and social media updates, agreed, whenever possible, with the other responders;
 - make agreed information available on the Internet;
 - actively monitor media reports including social media to ensure correct information is being broadcast/published;
 - ~~call a~~ schedule joint press conferences;
 - prepare a room for the media; and
 - control media access to the RCC and in other operational areas as appropriate.

1.10.6 Other considerations for public relations and management of a major incident include the following points:

- (a) As soon as it is apparent to the RCC public relations staff that a major incident has occurred, informing the media will help establish the RCC as ~~the~~ a primary source of information. Be clear, concise, and informative. Do not speculate.
- (b) Establishing the nationalities of those at risk will assist in anticipating where media enquiries will come from, and will assist in reducing media enquiries from States whose citizens are not involved.
- (c) Scheduling regular media conferences and updates, including regular social media updates, can help reduce the volume of media enquiries and assist with maintenance of consistent and correct public information. Media updates should also take into account international time zone differences.
- ~~(e)~~ (d) Due consideration should be given to the language used with the media. Local and international interest in the SAR operation may require use of a common language or availability of translators.
- (e) Ensure that arrangements are in place to deal sensitively with enquiries from friends and families of those involved and, where possible, to update next of kin ahead of the media.
- (f) Assign appropriate personnel to manage information demands from government and other senior levels.

[...]

1.10.8 Additional information on planning and public and media relations is provided in chapter 6 with regard to mass rescue operations.

[...]

1.12 Decision and management support

[...]

1.12.3 See also chapter 3.8 Risk assessment.

Chapter 2 – Communications

[...]

2.5.8 SOLAS ships sailing beyond range of a VHF DSC coast radio station must also have an MF DSC (2,187.5 kHz) transmitter and watch receiver. If sailing beyond range of an MF DSC coast radio station, they must have ~~an Inmarsat~~ an IMO recognized mobile satellite service Ship Earth Station (SES) or an MF/HF DSC transmitter and watch receiver including narrow-band direct printing (NBDP). If operating outside ~~Inmarsat~~ coverage of the IMO recognized mobile satellite service fitted to a ship (e.g. i.e. in the polar areas), they must have the MF/HF DSC capability.

[...]

2.6 406 MHz distress beacons, - EPIRBs, ELT and PLBs

[...]

2.10.4 (a) The services available to mobile telecommunications devices are provided over terrestrial radio systems which are connected to computer servers which record the activity, cell site connection and general locality of the user. This formation provides data which is of use to Search and Rescue authorities who may need to identify the location of persons in actual or possible danger e.g. overdue vessel, aircraft or persons on land

2.10.4 (b) Persons who are in danger or overdue, might have use of an alerting and tracking mobile telephone app. The SMC should consider this possibility and make enquiries to try to discover and identify the app in use. Once this is achieved, it may be possible to contact the app provider, or emergency contact for the app user, or to obtain location and tracking information in other ways. An app is a computer program designed to run on a mobile device such as a smartphone or tablet computer.

2.10.5 When receiving an alert via mobile telephone, SAR personnel should obtain the following information:

- caller's complete mobile telephone number;
- caller's mobile service provider;
- roam number if needed to recall the user; - other means of available communications; and - an alternative point of contact;
- battery level and if they have a back-up power source; and
- ask caller if they use a mobile telephone tracking or emergency app. If yes, ask them what type of app it is and to activate the emergency alert or locating function.

2.10.5 (b) If an RCC receives a report of a missing or overdue person, the SMC should ask the informant if the missing person(s) uses a tracking and locating app. If yes, the SMC should ask for details about the type and name of the app.

[...]

2.10.12 [...] corroboration of any GNSS position. Appendix U provides a process to determine the location of a mobile communications device.

[...]

2.12.2 If they have the capabilities, vessels normally monitor any DSC distress frequency available, as well as MSI (NAVTEX, SafetyNET, etc.) and INMARSAT broadcasts. Most vessels monitor channel 16; when practicable, some ships may discontinue aural radio watches and depend more on alarms to make them aware of incoming distress traffic. Persons on board vessels or aircraft may also carry mobile telecommunications devices e.g. mobile telephones. These devices may be a means of communicating with them.

[...]

2.24.5 [...] Having a very precise GNSS search target object position is valuable, ...

2.24.6 Persons on board vessels or aircraft may have a mobile telecommunications device e.g. mobile telephone which, if within terrestrial mobile phone coverage, may provide general location information. The phone user may also have the capability to use an

emergency app which may provide tracking and alerting capabilities using the terrestrial mobile telecommunications system. If persons in danger are within their mobile telephone provider's coverage area, the app location or tracking data may provide current position, track history and/or last known position (LKP).

[...]

2.27 SAR operations communications

2.27.1 The SAR plan should publish the frequencies available for assignment as control, on-scene, monitoring, homing, and public relations channels. Use should be made of any existing communications facilities where practicable and all facilities should be regularly used or tested.

2.27.2 The SMC should select SAR-dedicated frequencies, inform the OSC, ACO or SAR facilities, and establish communications with adjacent RCCs and SAR facility parent agencies as appropriate. If multiple assets are assigned, the OSC should maintain communications with all maritime SAR facilities and the ACO with all aeronautical SAR facilities and both with the SMC; the OSC and ACO would communicate with each other as specified by the SMC. A primary and secondary frequency should be assigned for on-scene communications.

2.27.3 The OSC should be authorized to control communications on scene and ensure that reliable communications are maintained. SAR facilities normally report to the OSC and/or ACO on an assigned frequency. If a frequency shift is carried out, instructions should be provided about what to do if intended communications cannot be re-established on the new frequency. All SRUs should carry a copy of the International Code of Signals and the IMO Standard Marine Communication Phrases, which contains—contain internationally recognized communications information internationally recognized by aircraft, vessels, and survivors.

2.27.4 Additional information on communications planning for mass rescue operations is provided in chapter 6 and appendix C.

[...]

2.28.12 [...]...the last known position, search target object description, ...

[...]

2.28.16 (a) [...]...primary and secondary search targets objects, ...

[...]

2.34.1 Various forms of communication can be used for vessel tracking. Ship reporting systems can use voice reporting over VHF and HF, DSC and Inmarsat mobile satellite services (IMO recognized or other mobile service). Many ship reporting systems use Inmarsat-C polling or Inmarsat automated position reporting (APR). AIS uses a time-division multiple access (TDMA) scheme to share the VHF frequency, also known as the VHF Data Link (VDL). There are two dedicated frequencies used for AIS: AIS 1 (161.975 MHz) and AIS 2 (162.025 MHz). LRIT can employ any form of communication which meets the required functional specification, but most vessels use Inmarsat equipment to report every six hours to their data centre via a communications provider and application service provider. Vessel monitoring systems (VMS) can use various systems for tracking, including Inmarsat, Iridium and Argos.

[...]

- 2.36 (c)** Are there any ~~targets~~ search objects on radar or AIS in the direction of the SART?

Chapter 3 – Awareness and initial action

[...]

- 3.4.4** – telephone number of pilot in command or any other person on board; and
– any member of the crew or passengers known to make use of an emergency tracking or locating app.

[...]

3.5.2 [...]

- (f)** Conduct a communication search including obtaining information about any mobile telephone devices e.g. cell-phone, carried and locating and tracking apps used by persons on board.
- (g)** For ships...
- (h)** consider if any person on board has a mobile device and/or tracking and locating app and investigate access to this information which may provide track history and/or current location.

3.8 General considerations for the SMC

[...]

Urgency of response

- 3.8.5** The nature of the incident and the rate at which the situation may worsen usually determine the urgency of response. The SAR system should provide prompt and effective assistance to all incidents, particularly those involving grave or imminent danger.

[...] *[The remaining existing text in this paragraph contains remarks on urgency in "ordinary" SAR cases.]*

- 3.8.6** Initiating the response effectively is of vital importance. The SMC must be able to recognize the level of response that is, or may be, required, and notify all who may have to act. If in doubt it is usually better to alert potential responders early, even if the decision is made later that they are not needed. Time lost at the beginning of the response cannot be regained. But the SMC should also consider the impact of precautionary alerting on subsequent SRU availability. Crews kept on stand-by during designated rest periods will need earlier relief.

- 3.8.7** Passing on the alert and subsequent information to multiple recipients is best done by "cascading" it in various pre-planned streams, so that all who need to know are informed efficiently and without delay, and so that the RCC staff can focus on their part of the operation after initiating the information flow. It is good practice to use pre-prepared checklists of all who should be informed. Additional guidance on planning for mass rescue operations is provided in chapter 6.

[Renumber current 3.8.6 through 3.8.10 paragraphs]

3.8.1012 *New text added to end of renumbered 3.8.12 Flares:*

Information required from informants. To enable effective search planning the following additional questions need to be asked:

- (a) height of eye (for an informant on board a vessel or height above sea level for a person on land – this may have to be assessed by reference to a suitable map);
- (b) weather conditions in the area (visibility, rain, fog, mist, haze, low cloud);
- (c) *actions by vessels.* If the informant is on a vessel, ask them to immediately turn onto the heading of the flare sighting (if it is safe to do so) and proceed at slow speed in that direction whilst posting extra lookouts. If it is night time, to use searchlights and/or white flares (if available) to illuminate the area and/or indicate to any survivors that someone is looking for them.

Causes of erroneous flare sighting:

- military exercises e.g. dropping or firing of flares, aircraft afterburners, weapon firing;
- ship lights;
- offshore energy industry installation lights or flare stacks, etc.
- aids to Navigation (lights from buoys, etc.);
- ascending or descending aircraft (especially if there are airfields or airports near to or on the coast);
- fireworks displays;
- weapons ranges;
- fishing boat deck and working lights;
- meteor showers; and
- festivals using lanterns or other such lighting;

Points to note regarding erroneous sightings:

- the sky must be relatively clear for meteors and other objects entering the atmosphere to be seen;
- meteors move at high speed;
- suitable information on these activities should always be kept in the RCC for reference during the investigation of "flare" sighting reports;

- reports of "orange" flares are quite common. These reports may be caused by white flares seen from a distance. The fact that the air is full of airborne dust and other particulate matter causes white light from the flare to be distorted and this then can show as an orange colour;
- out-of-date distress flares can become discoloured. Informants should be questioned very carefully about the colour of any flare sighted; and
- the wake or streak from a meteorite is caused by the observer's retina retaining an "afterglow" effect.

Unattributed sightings. The term "unattributed flare sighting" does not necessarily mean that no one is in distress. It means that the source of the flare is unknown. If the source of a distress flare cannot be confirmed, it must be investigated to determine the cause of the sighting and ensure, with reasonable certainty that no vessel, aircraft or person is in distress.

Types of flares. There are generally three types of flares available and used for distress signalling:

- parachute flare: Widely available parachute distress flares are used by commercial ships, fishing vessels and small craft mariners;
- meteor flare: Rocket type (i.e. non-parachute) flare; and
- hand-held flare: Standard international distress flare used by commercial and recreational users. Hand-held flares will normally only be detectable by an observer as far as the physical horizon.

Range and bearing estimation techniques and range tables. Techniques to determine the range and bearing of pyrotechnic distress signals (with error factors) are in Appendix K (Determining Datum, Estimating Range and Bearing of Pyrotechnic Distress Signals), and associated height and range tables are in Appendix N (Pyrotechnic Distress Signals Minimum and Maximum Range Tables).

Risk assessment

3.8.4113 *SAR operations risks.* Safe and effective SAR operations depend on coordinated teamwork and sound judgement relating to risk assessment. Saving distressed persons and the safety of SAR personnel should be of equal concern to the SMC. Once SAR personnel are proficient in their duties, the team leader, e.g. pilot in command, captain, SMC, or OSC, must ensure that the personnel perform properly as a team with a common mission. Mishaps often follow a chain of errors that can start with mistakes made during SAR planning and lead to poor decisions during operations. Team safety is supported by keeping everyone informed, matching resource capabilities to tasks, detecting and avoiding errors early, following standard procedures, and adjusting to non-standard activities

- (a) All reasonable action should be taken to locate distressed persons, determine their status, and effect their rescue. However, the risks inherent in any SAR response must be considered against the chances for success and the safety of SAR personnel.

- (b) The search or rescue action plan provided by the SMC is guidance for the OSC and SAR facilities on scene. The OSC may adjust the action plan based on the situation on scene; however, when practicable, the OSC should only vary facility tasking after consultation with the SMC. SAR facilities should keep the OSC advised of any difficulties encountered.

3.8.14 Efficient response to incidents requires good situational awareness and effective communication processes between all parties involved. Dynamic risk assessment is required, with assessment of the safety level on scene based on the different threat factors identified.

3.8.15 This assessment should be repeated as necessary during the response. Changes in the threat factors and their severity indicate how the situation is evolving and thus provide important information for the responsible RCC and other organizations and participating units.

3.8.16
3.8.17

Chapter 4 – Search planning and evaluation concepts

4.2 Evaluating the situation

[...] *[Paragraph 4.2.1 discusses search criteria in general.]*

4.2.1 bis Accounting for everyone at risk requires great care in any SAR operation. This is particularly so in complex situations such as mass rescue operations (see chapter 6). In many cases, especially in the early stages of the SAR response, it may not be clear how many people are at risk, and accounting for everyone involved (including deployed responders) can be very difficult. It follows that search action will be needed wherever there is a risk that anyone involved will not be located quickly. The search should be continued until everyone has been accounted for or there is no longer hope of finding further survivors. The operational area should be carefully monitored and should be contained, to guard against people leaving it unnoticed. In maritime situations, units should be stationed down-drift.

[...]

Chapter 5 – Search Techniques and Operations

5.2 Selection of search facilities

5.2.1 The types and numbers of available search facilities, along with their calculated sweep width(s), determine how much search effort will be available at the scene. Small search efforts will result in correspondingly small probabilities of success, even when the effort is deployed in the most optimal fashion, and it will probably take longer to locate survivors. Since survival times may be limited and locating survivors almost always becomes more difficult as time passes, it may be necessary to seek additional search facilities early in the search planning process. It is usually preferable to use larger rather than smaller numbers of search facilities for the first few searches. By doing this, survivors are often located sooner rather than later, and the need for a much larger, prolonged search effort is avoided. No matter how many search facilities the search planner tries to obtain, it is unlikely that so many will be made available that they cannot be used effectively.

5.2.1 bis In some cases – mass rescue operations, for example: see chapter 6 – ongoing search action may be required while rescue operations are also under way. The SMC should carefully select appropriate facilities for each part of the operation. Some units will be better suited to rescue work and others better employed in search activity.

[...]

Briefing of air search personnel

5.15.2 Briefings should include all items detailed on the briefing form in appendix H and any other important information available, and should include:

[...]

– details of other SAR facilities engaged and their search or other operating areas;

[...]

Chapter 6 – Rescue planning and operations

[...]

6.1.2 In times of armed conflict, SAR services will normally continue to be provided in accordance with the Second Geneva Convention of 1949 (Geneva Convention for the Amelioration of the Condition of Wounded, Sick and Shipwrecked Members of the Armed Forces at Sea, of 12 August 1949) and Additional Protocol I to the Conventions.

- (a) The SAR services recognized by their Administrations are afforded protection for their humanitarian missions so far as operational requirements permit. Such protection applies to coastal rescue craft, their personnel, and fixed coastal SAR installations, including RCCs and RSCs as far as these centres are located in coastal areas and are used exclusively to coordinate search and rescue operations. SAR personnel should be informed about their Administration's status regarding, and views on the implementation of, the Second Geneva Convention and its Additional Protocol I.
- (b) Chapter XIV of the International Code of Signals illustrates the different means of identification that shall be used to provide effective protection for rescue craft.
- (c) The above-mentioned coastal installations should, in time of armed conflict, display the distinctive emblem (red cross, ~~or~~ red crescent or red crystal), according to regulations issued by their competent authorities.
- (d) It is recommended that Parties to a conflict notify the other Parties with the name, description and locations (or area of activity) of their above-mentioned rescue craft and coastal installations in the area they are located.

Note: The guidance in paragraph 6.1.2 above has been approved by the International Committee of the Red Cross. For further guidance, see Volume I, chapter 1.8.

[...]

6.3 Delivery of rescue personnel and equipment

6.3.1 Maritime SRUs are a reliable means of delivering supplies, equipment, and personnel to the scene of a distress. Equipment may include ~~bilge~~ portable pumps, towing equipment, fire-fighting equipment, and medical supplies. Personnel delivery ~~is usually limited to~~ may include firefighting, medical and/or salvage personnel or repair and support parties.

6.3.2 Air delivery of supplies, equipment, or personnel to the ~~distress~~ scene is ~~usually~~ the most expeditious method. Helicopters are particularly suitable for this purpose and are usually the primary means for delivering personnel. Personnel delivery by fixed-wing aircraft is limited to ~~pararescue personnel~~ specialists.

6.3.2bis MSC.1/Circ.1183 provides further guidance on the provision of external support as an aid to incident containment, and appendix G to this Volume includes further information on supplies and survival equipment.

[...]

6.4 Delivery of rescue personnel and equipment

[...]

6.4.3 Droppable containers and packages [...]

[...]

(b) The contents of each container or package should be clearly indicated in print in English and ~~two or more other~~ additional languages appropriate to the intended area of operation or using self-explanatory symbols, and may also be indicated by ~~colour-coded streamers and~~ pictograms discussed in appendix G, section G-7.

[...]

6.7 Rescue by aircraft

[...]

6.7.5 Helicopters can be used to rescue survivors by winching or by landing on a ship if a suitable location exists and the vessel is in a suitable condition. Water landings are possible when amphibious helicopters are used. Helicopters which are unable to perform a rescue may be used to drop supplies to survivors to sustain life until rescue can be effected. Inability to rescue may be due to a helicopter not having a rescue capability, on-scene conditions, or a situation where the number of survivors exceeds the helicopter's immediate rescue capacity. Due to their unique flying capabilities, ~~they~~ helicopters should be ~~used~~ considered for use for specialist rescue tasks ~~whenever possible~~. They are particularly suitable for rescues in heavy seas, ~~or~~ at locations where surface facilities are unable to operate, or for the rescue of individuals such as the severely injured or infirm whose presence is complicating a wider rescue operation. However, there are special concerns of which the SMC must be aware:
[...]

6.15 Mass rescue operations

MRO overview

6.15.1 A mass rescue operation (MRO) is ~~one that involves~~ characterized by a need for immediate ~~assistance response~~ to large numbers of persons in distress such that the capabilities normally available to SAR authorities are inadequate. It is therefore necessary to plan to enhance SAR capability in MROs. Three means of doing ~~so~~ this are to:

- agree to share SAR facilities regionally and/or internationally;

- identify additional SAR facilities locally, including shipping in the area; and
- extend survival time by providing support to persons in distress until they can be rescued.

Further information on the identification and selection of SAR facilities, and on the provision of supporting supplies and survival equipment, is included in appendix G.

6.15.2 MROs will bring together organizations, at sea and on land, who do not usually work together. It is vital that these organizations communicate effectively at all stages – before and after an MRO as well as during it. Effective communications communication begins long before any MRO, at the planning stage, and also includes post-incident analysis and identification of learning points to improve arrangements and processes based on the experience gained.

6.15.23 MROs are relatively rare, low-probability high-consequence events compared to normal SAR operations. But major incidents leading to the need for MROs have not been infrequent on a worldwide basis, and can occur anywhere at any time. The nature of such operations may be poorly understood due to limited chances to gain experience with major of such incidents involving MROs. It is therefore important to share, and to study, lessons learned identified in actual MROs and during the planning, training and testing phases of MRO preparation. See chapter 9 for further information on the sharing of lessons identified.

6.15.34 Flooding, earthquakes, terrorism, casualties emergencies in the offshore oil energy industry and accidents involving releases of hazardous materials are examples which, because of their magnitude scale, may require the application of the same resources as required for mass maritime or aeronautical rescue operations. There are many potential causes of MROs, and the risks should be analysed locally: but the effects are more important than the causes for response planning purposes.

6.15.4 5 The sequence of priority in major multi-mission incidents must be lifesaving first, generally followed by environmental protection, and then protection of property. Moral and legal obligations and public and political expectations require preparedness to carry out MROs safely and effectively should they become necessary. Since the need for MROs is relatively rare, it is difficult to gain practical experience to help deal with them. Types of potential MRO scenarios vary, but there are certain general principles that can be followed based on lessons of history.

6.15.56 Effective response to such major incidents requires immediate, well-planned and closely coordinated large-scale actions and use of resources from multiple organizations. The following are typical MRO demands:

- intense and sustained high priority lifesaving efforts may need to be carried out at the same time and place as major efforts to save protect the environment and property;
- huge amounts of information need to be readily available at the right times and places to support the response efforts and meet the needs of emergency responders, the news media, the public, and friends and families of the persons in distress, which who may number in the hundreds or thousands;

- many means of ~~communications~~ communication need to be available and interlinked amongst organizations at various levels to handle ~~huge amounts of this~~ information reliably for the duration of the response. (MRO communications are discussed in more detail later in this chapter);
- ~~a surge in the numbers~~ an increase in the number of competent staffing in all key organizations must be made available immediately and be sustainable for up to weeks at a time;
- equipment and logistics demands ~~jump~~ may increase to unprecedented levels; and
- successful MROs depend on the advance provision of flexible and all-level contingency plans. Intense integrated planning and operational efforts must also be carried out in real time throughout ~~actual~~ the rescue efforts.

6.15.67 All involved in the overall multi-agency, multi-jurisdiction, multi-mission and possibly international response to major incidents must clearly understand who is in charge, the respective roles of all involved, and how to interact with each other. SAR authorities may be responsible for all or part of the MRO functions, and must be able to coordinate their efforts ~~seamlessly~~ with other responders under the overall direction of another authority within or outside their own agency. It is therefore essential for as many potential MRO responders as practicable to plan and train together.

6.15.7.8 The broader response environment may involve activities such as:

- hazards mitigation;
- damage control and salvage operations;
- pollution control;
- complex traffic management;
- large-scale logistics efforts;
- medical and coroner functions;
- accident-incident investigation; and
- intense public and political attention.

6.15.89 MRO plans need to be part of and compatible with overall response plans for major incidents. Plans must typically allow for command, control and communications structures that can accommodate simultaneous air, sea and land operations.

6.15.1110 There ~~will often~~ may be resistance to paying the high price in terms of time, effort and funding that preparedness for major incidents entails, particularly as they are rare events. The ~~required~~ levels of cooperation, coordination, planning, resources and exercises required for preparedness are challenging and do not happen without the ~~requisite~~ active commitment of SAR authorities, regulatory authorities, transportation companies, sources of military and commercial assistance and others.

6.15.911 The consequences of poor preparations for MROs in terms of loss of life and other adverse results may be disastrous. Major incidents may involve hundreds or thousands of persons in distress in remote and hostile environments. A large passenger ship collision, a downed aircraft, or a terrorist incident could, for example, call for the immediate rescue of large numbers of passengers and crew in poor environmental conditions, with many of the survivors having little ability to help themselves.

- 6.15.4012** Preparedness to mount an extraordinarily large and rapid response is critical to preventing large-scale loss of lives. Such preparedness often depends on strong and visionary leadership and unusual levels of cooperation at the planning stage.
- 6.15.4213** MRO planning, preparations and exercises are essential since opportunities to handle actual incidents involving mass rescues are rare. Therefore the exercising of MRO plans is particularly important.
- 6.15.4314** Appendix C provides guidance on MRO exercise planning. MSC.1/Circ.1183 provides further guidance on the provision of external support as an aid to incident containment.
- 6.15.15** The International Maritime Rescue Federation (IMRF) has developed detailed guidance on preparing for maritime MROs. This may be downloaded from www.imrfmro.org.

General guidance for MROs

- 6.15.4416** For a situation involving large numbers ~~or~~ of persons in distress, on-scene responsibilities for ~~the~~ their safety of passengers and crew will be shared. ~~by the OSC and the craft's pilot in command or master, with the pilot or master assuming as much of this responsibility as possible before or after the aircraft or ship is abandoned.~~ On-scene responsibilities Responsibility for the safety of passengers and crew remain with the person in charge of the craft in distress while that person is still in command. During the rescue/recovery operation responsibilities for the safety of passengers and crew are shared by the person in charge of the craft in distress and the pilot in command or master of the rescue unit. The ~~pilot in command or master~~ commander of each rescue unit has responsibility for the safety of survivors while they are on board the rescue unit. The OSC and ACO have responsibilities relating to the safe coordination of SAR efforts on scene.
- ~~**6.15.15** Pilots and masters are responsible for manoeuvring the aircraft or ship as feasible and appropriate and also have overall responsibility for safety, medical care, communications, fire and damage control, maintaining order and providing general direction.~~
- 6.15.16** ~~17~~ Unless a ship appears to be in imminent danger of sinking, it is usually advisable for passengers and crew to remain on board as long as it is safe to do so. Recovery of people from survival craft at sea is a complex and potentially hazardous operation. Keeping people aboard a ship in distress may be safer in some circumstances. However, evacuation of a ship at sea takes time, especially if the ship is damaged. The ship's master may have to make the difficult decision to order the commencement of an evacuation without knowing whether or not it is absolutely necessary. The SMC must be ready to support the master's decision, by providing on-board support where necessary and possible, and SAR facilities on scene in case of evacuation. ~~(Regarding recovery techniques, IMO provides more information~~ guidance on the retrieval of people from the water and from survival craft in its *Pocket Guide to Recovery Techniques and in Volume III of this Manual*.~~)~~
- 6.15.17** ~~18~~ In the case of a downed aircraft, each incident is unique in deciding whether passengers people would be safer on board or should evacuate. ~~be assessed for each situation.~~ Usually, at sea, they should promptly evacuate the aircraft. ~~at sea.~~ ~~whereas on-~~ On land, this decision ~~must~~ will take into account the conditions of the aircraft and the environment, expected time to rescue survivors ~~or repair the aircraft,~~ and whether required survivor passenger care can be best provided inside the aircraft.

- 6.15.18** ~~19~~ The In an MRO an OSC will should normally be designated by an the SMC. An OSC may be able to handle certain communications on scene and with appropriate remote authorities to help free the pilot or master to retain the integrity of his or her craft. Where there is a pilot or master still in command of a craft in distress, the OSC acts in support of this person, However, these persons are themselves in need of assistance, and anything the OSC can do to help them should be considered, bearing in mind that the OSC's main duty is co-ordinating primary responsibility is to coordinate SAR facilities and rescue efforts under the SMC's general direction.
- 6.15.19** ~~20~~ Unnecessary communications with the master of a ship or pilot in command of an aircraft in distress must be minimized, and this should be taken into account in advance planning. ~~6.15.20~~ Exchanges of information during joint planning by use of SAR Plans of Cooperation for passenger ships, and by other agreed means, will reduce the need to ask the pilot or master for this information one or more times during a crisis. Persons or organizations that want Responders requiring this information should be directed to a source ashore or on the ground that is prepared to handle many potential requests; the response teams at the shipping company or the airline involved, for example.
- 6.15.21** High priority should be given to tracking and accounting for all persons involved in the operation – on board the distressed craft, and all lifeboats and rafts aboard survival craft and elsewhere. , and Efforts to keep them together will help in this regard. Availability of accurate manifests and accounting is critical. Search action should be carried out and the scene patrolled as a matter of course, to guard against people being overlooked.
- 6.15.22** The need to relocate survival craft and check for persons in them can waste valuable resources. One option is to sink survival craft once the persons in them have been rescued; If possible, survival craft should be recovered or sunk after the people in them have been retrieved, to avoid wasting valuable resource in checking empty craft subsequently. However, the potential that other survivors may find and need the craft should be considered before they are disposed of.
- 6.15.23** ~~Navy ships~~ Naval vessels and large passenger ships are often better equipped than other vessels types of vessel for retrieving survivors: people who have abandoned a ship or aircraft; but use of any such available ships should must be considered. Ship reporting systems for SAR may help identify commercial ships available to assist.
- 6.15.26** ~~24~~ If a ship with a large freeboard cannot safely retrieve survivors from the water or survival craft, it may be possible to first retrieve them onto small vessels, and then transfer them to progressively larger ones. ~~6.15.27~~ Depending on the circumstances, it may be safer to tow survival craft to shore without removing the occupants at sea. Lifeboats could be designed to support passengers for longer periods of time, and to be able to reach shore on their own from longer distances offshore. Consideration should also be given to passing survival equipment and supplies to people in distress, to sustain them until they can be rescued.
- 6.15.24** ~~25~~ Helicopter capabilities should be used if available, especially for retrieval of weak or immobile survivors. Aircraft may also be used to deliver equipment and supplies to sustain life pending rescue. ~~6.15.25~~ Shipping companies should be are encouraged to equip large passenger ships and possibly other types of their vessels with helicopter landing areas or clearly marked hoist-winch areas to facilitate direct transfers.

6.15.26 ~~Lifeboat crews should be trained in helicopter hoist operations. Crew members who may become involved in helicopter hoist operations, including survival craft and surface SAR unit crews, should be made familiar with the usual procedures. See "Vessel/helicopter operations" in Volume III. Lowering a rescue person from the helicopter to assist survivors may be viable.~~

6.15.28 ~~27~~ To the extent practicable, MROs should be coordinated by an SMC in an RCC, and the SAR element should always be so. However, depending on the magnitude, nature and complexity of an the incident, the rescue efforts overall response may be better coordinated by an appropriate operations centre higher within the SAR agency or another Government agency, so that the SMC can focus on the SAR effort. Considerations in this decision might include, among others:

- extensive and complex SAR workload for the RCC staff;
- extensive rescue support by organizations other than those commonly used for SAR;
- need for heavy-international diplomatic support; and
- serious problems in addition to potential loss of lives, such as environmental threats, terrorist actions, or national security issues.

If this approach is intended, it is essential that it is pre-planned, with full involvement of all parties, including the RCC staff, to avoid confusion at the time of an incident. The plan may, for example, provide for the RCC to maintain coordination of the SAR response while the higher operations centre handles the wider issues.

6.15.29 ~~28~~ The following factors should be considered in MRO planning:

- use of the Incident Command System (ICS) discussed below, or other effective means of handling coordinating multi-agency, multi-jurisdiction, multi-mission scenarios;
- identification and analysis of situations within the SRR that could potentially lead to the need for MROs, including scenarios that might involve cascading casualties or outages;
- mobilization and coordination of necessary SAR facilities, including those not normally available used for SAR services: see appendix G for further information;
- ability to activate plans immediately;
- call-up procedures for needed personnel;
- need for supplemental communications capabilities, possibly including the need for interpreters;
- dispatching use of liaison officers;
- activation of additional staff to augment, replace or sustain needed staffing levels;
- need for supplemental information technology and telecommunications facilities, in case of overload;

- best use of the air and surface SAR facilities available;
- recovery and transport of large numbers of survivors (including those unfit, injured or incapable) , ~~recovery of bodies, if necessary), accounting for survivors with suspected injuries, guarding against and caring for person with hypothermia, etc.;~~
- triage classification tools such as numbered and/or coloured cards or tags (see section 6.17);
- identification of potential landing sites;
- identification of potential places of safety (survivor reception centres);
- providing for survivors' needs, including medical needs, during the transfer to places of safety, guarding against hypothermia etc.;
- recovery and handling of bodies;
- a means of reliably accounting for everyone involved, including responders, survivors, crew, etc.;
- efficient and smooth handover from SAR facilities to shore/land response units at landing points / places of safety;
- care, assistance and further transfer of survivors once delivered to a place of safety and further transfer of bodies beyond their initial delivery point;
- activation of plans for notifying, managing and assisting the ~~media and families and friends of those involved in large numbers;~~
- activation of plans for working with the news and social media;
- control of access to the RCC and other sensitive facilities and locations;
- RCC backup and relocation plans, as appropriate; and
- ready availability to all potential users of plans, checklists, ~~and~~ flowcharts, etc.

6.15.3029 The ability of an RCC to continue to effectively coordinate the MRO and still handle its other SAR responsibilities may become overwhelmed, and another RCC/RSC or a higher other authority may need to ~~assist assume responsibility for their other responsibilities.~~

6.15.3130 With these possibilities in mind, MRO plans should provide for various degrees of response, along with criteria for determining which degree of response will be implemented. For example, as local SAR resources are exhausted (~~or from the outset~~), SAR resources may need to be obtained from distant national or international sources. These resources will need to be alerted at the outset, and may need to move forward so as to be ready when required.

6.15.3231 Experiences in responding to major incidents have resulted in the following practical guidance. Authorities should:

- plan how any agency receiving notification of an actual or potential mass rescue event can immediately alert the RCC, the responsible lead SAR agency and ~~conference call~~ other authorities that will potentially be involved, brief them, and enable immediate actions to be taken by all concerned (this will require identification of entities in each agency that can be contacted on a 24-hour basis, and that have authority to immediately initiate actions and commit resources);
- train all staff who will be involved;
- conduct exercises, to test both the above plans and the training;
- coordinate all search and rescue operations effectively from the very beginning;
- begin quickly with a high level of effort and stand down as appropriate rather than begin too late or with too little effort;
- ensure that MRO emergency plans address communications needs and interoperability ~~or interlinking~~;
- be prepared to use an Incident Command System (ICS) or equivalent when appropriate;
- ensure that air traffic, ~~and~~ air space and sea or land traffic can be and is controlled on and around the scene;
- assign additional liaison personnel on scene, as required;
- anticipate incident development and needs and act early;
- ensure that the scope of SAR plans and other emergency or disaster response plans, including company emergency response plans, are coordinated to reduce gaps, overlaps and confusion about the person in overall charge and the command, coordination and communication structures, and the procedures to be followed at various times and places;
- determine in advance how private resources can be appropriately used to supplement other SAR resources;
- use capable resources like ~~cruise~~ passenger ships for taking large numbers of survivors on board;
- control access to the scene, including access by the news media;
- retrieve and protect debris as evidence for follow-on investigation;
- put security plans in place to limit access to the RCC;
- arrange in advance to involve the Red Cross / Red Crescent, ~~chaplains~~, critical incident stress experts and other such support for human needs;

- identify senior agency spokespersons to protect the time of workers directly involved in the response and designate a senior official to provide information to families;
- clearly identify the point at which the SAR response (lifesaving) has ended and the focus shifts to investigation and recovery, noting that these may be parallel processes during a response;
- ensure that SAR plans provide for logistics and welfare support for large numbers of rescuers and survivors including pre-arranged accommodations, if possible, and availability of food, medical care and transportation;
- consider requesting assistance from airlines and shipping companies other than the one whose aircraft or ship is involved in the incident, and know the types of assistance that such organizations might provide;
- ~~— consider use of bar coded bracelets as an effective means of identifying children before, during and after the emergency;~~
- attempt to reduce the burden on the distressed craft's pilot or master and crews: in maritime cases, if safe and appropriate to do so, place a marine casualty officer on board to assist the master and SAR personnel; and
- share capabilities, expertise and assets among Government and industry to take maximum advantage of the strengths of each.

Communications planning for mass rescue operations

6.15.3332 Communication plans must provide for a heavy volume of communication use as a major incident will normally involve many responding organizations that need to communicate effectively with each other from the beginning. It is likely that the volume of communications at the beginning of an MRO will be very high and potentially confused. This must be prepared for and managed until the situation becomes more stable. ~~6.15.34 As necessary, a~~ Advance arrangements should be made as necessary to link means of interagency communications systems that are not inherently interoperable. ~~6.15.35~~ Interagency communications must be based on terminology understood by all involved.

Communications planning for MROs

6.15.3633 Efficient MRO responses depend upon efficient communication, and efficient communication requires planning, understanding of the plan by those who will have to put it into effect and its rapid implementation at the time of the incident. The following are some of the factors MRO communications planners are recommended to consider:

- Who is likely to be involved in the response to a MRO, including supporting organizations and others with legitimate interest (e.g. officials, family members of victims, the news media, etc.)?
- What are their information needs likely to be?

- Where do they fit in the overall command, control and coordination (and, therefore, communications) structure?
- What are the information priorities?
- What communications facilities do the responders have?
- Are there enough people to operate the communications systems, over a potentially long period? The planning should include provision for relief personnel.
- How should these facilities best be used to avoid overload? How should a large amount of data (such as search plans or passenger lists) be communicated?
- Do people know what to say and who to talk to? Do they understand their unit's place in the communications network, other units' roles, and the overall information priorities? Are they aware of the importance of clear procedures and communications discipline?
- Are there likely to be language difficulties, including potential misunderstanding of technical language?
- Who will control and keep order on the various parts of the communications network and do they understand this particularly important role?
- To what extent are different responders' communications systems and procedures interoperable? Can communications hubs be established or liaison officers exchanged to help explain priorities, procedures and technical language?
- Can common communications devices be provided to responding units to enable direct communications between them?
- How long might the incident last? Distress frequencies may be used for the initial response but the plan should ensure that these frequencies are cleared as soon as practicable.
- What will the social media impact be, and how can it be addressed?

6.15.37 Appendix C outlines a basic MRO communications plan structure.

Major incident coordination

6.15.3834 Regardless of the magnitude and priority of the life-saving efforts involved in responding to a major incident, if any other functions are being carried out concurrently on scene by other than SAR personnel, the overall response involving SAR and the other functions, e.g. fire-fighting, ~~should~~ **must** be well coordinated. ~~6.15.39~~ If ~~certain~~ basic concepts and terms are recognized and understood by all emergency responders, they will be much better prepared to coordinate joint efforts.

6.15.4035 Standard SAR procedures should typically be followed for the SAR part of the response, but these procedures will be largely independent of other efforts. Companies or authorities handling other aspects of the response will follow command, control and communication procedures developed for their respective organizations and duties. ~~6.15.44~~ The SAR system can function in its normal manner or use

modified SAR procedures established to account for the special demands of mass rescues, but it should be appropriately linked and subjected to a scheme for management of the overall incident response.

6.15.4236 For major incidents, crisis management for the overall response may also be needed. The Incident Command System (ICS) is one simple and effective means of meeting this need. ICS can be used where no equivalent means of overall incident management is in place. SAR and transportation authorities are likely to encounter use of the ICS within emergency response communities. 6.15.43 The ICS works best with some advance familiarization and exercising. 6.15.44 Appendix C provides general information about ICS.

Landing Sites

6.15.37 Ideally, a single landing site will be established for the mass rescue incident. A single site enables all land support resources to be consolidated at one location. This reduces overhead requirements and facilitates response management. Multiple sites require more people and material – both of which are often in short supply during a crisis.

6.15.38 However, some mass rescue operations may require multiple landing sites due to geographic location and range, number of evacuees, landing site size or arrangement, rescue vessel or aircraft limitations, or other reasons. Each site must be established and managed to meet the functions expected. Considerations include:

- Proximity to incident location
- Proximity to land support facilities; for example, hospitals and suitable reception centres
- Land facilities' survivor support capacity.
- Waterside access for rescue vessels.
- Safe landing areas for aircraft.
- Aircraft refuelling facilities, especially for helicopters.
- Sufficient aircraft apron parking space.
- Ease of transfer from rescue craft to land.
- Land transportation access.
- Crowd control and foot traffic flow.
- Disabled and other special needs requirements.
- Sufficient space for assembly of survivors.
- Adequate space for medical and other support services.
- Sheltering capability.
- Site control & security capability.
- Secure location for retrieved debris for investigation purposes.

Industry planning and response

- 6.15.45-39** SAR authorities should coordinate MRO plans with companies that operate ships and aircraft designed to carry large numbers of persons. Such companies should share in preparations to minimize the chances that MROs will be needed, and to ensure success if they become necessary.
- 6.15.46-40** Appendix C provides guidance on industry roles and discusses how companies could arrange for use of field teams and emergency response centres as possible means of carrying out their MRO responsibilities.
- 6.15.47-41** For passenger ships, SAR Plans of Cooperation required by the Safety of Life at Sea Convention and developed by SAR authorities and shipping companies are part of the MRO plans process and a useful tool in the early stages of the response to an incident involving a passenger ship, either as casualty or a SAR facility.

Public and media relations for MROs

- 6.15.48-42** Good public and media relations, including on social media, are very important but also become very demanding and quite important during MROs. Included in this are social media and awareness that industry, particularly Airlines and/or passenger shipping companies involved will be working intensively with the news media, and may be making use of social media. and, therefore, SAR authorities should collaborate with them on the flow of information with them. 6.15.49 What the media reports may matter more than what SAR services do for shaping public opinion about MROs. The role of the media may be critical in shaping the reactions of the public and of those directly involved in the distress situation in a way that contributes to safety, control and success and panic control. There should be no unwarranted delays in providing information to the media.
- 6.15.50-43** Information should be readily available, clear, accurate, consistent and freely exchanged among emergency responders and others concerned, such as the public and families of persons on board. 6.15.51 Designate the person who will speak to the public and the media and 6.15.56 Many entities are may be involved in a the response to a major incident, including ships, aircraft, companies and SAR services. Coordination is required to ensure that there is one message with many messengers. Develop agreed press releases and social media responses, and outline what they will say, staying factual appoint trained spokespeople. Use agreed and factual scripts. If SAR services do not provide a public spokesperson and information for a major incident, the media likely will, thus denying the Authorities the opportunity to manage the information and emphasize the appropriate points. Do not speculate, but do work with the news media to ensure that factual information is conveyed in an appropriate and timely manner. 6.15.55 Interviews should be live if possible.
- 6.15.52-44** A single spokesperson Appointing well-informed spokespeople not directly involved in the incident otherwise can be valuable in relieving the Incident Commander and SMC key response staff of this duty.
- 6.15.53** Spokespersons should be cautious about speculating on causes of accidents and ensure that the media understands that the main focus of current operations is on saving lives.
- 6.15.54** Ensure that the media knows who is in charge of co-ordinating rescue operations.

6.15.5845 The media is a rapid-response, 24-hour global market, and its news is broadcast world-wide. The media will find a way to get to the scene for first-hand information, pictures and video. By providing transportation to the scene and controlling media access, safety and the information the media reports can be better managed.

6.15.5746 Prompt establishment of a joint information centre at a location distant from the SMC will help to achieve this the goal of controlled public relations. (A joint information centre is a component of an ICS and is discussed in appendix C). The centre can establish proper procedures for establishing what the release of messages will be released to the public and how those messages will be released. Since the messages may be sensitive, it is critical that everyone communicates the same information. The centre can be responsible for coordinating information made available via the Internet and perhaps establishing and maintaining a public website and regular social media updates dedicated to the emergency response.

~~**6.15.59** Media outlets often have more resources to mobilize on scene than do SAR authorities, and RCC operating plans should account for how to deal with such situations.~~

6.15.6047 Information should be provided to the public on the SAR facilities being used and, if possible, a web address and/or list of contact phone numbers should be provided for families, media and others to contact for more information. ~~6.15.64~~ Preparations should be made so that large numbers of callers can be accommodated without saturating the phone system or crashing the computer server.

6.15.6248 Advance preparation of standby web pages by transportation companies and SAR authorities can help in responding to floods of requests for information. These pages can be quickly posted to provide general information for media and general public use. Web information (including information posted on social media) should be timely and accurate.

6.15.6349 Once posted, these pages can be easily updated with the status of the incident and could also include:

- contact information;
- basic Government, SAR service and/or industry facts;
- industry and SAR definitions;
- photographs and statistics of aircraft, ships and other SAR facilities;
- answers to frequently asked questions;
- links to other key websites;
- background information on the craft in distress, if available passenger capacity, crew size, vessel plans and fire-fighting capabilities; and
- library footage of a vessel inspection or of the crew performing lifesaving drills.

~~**6.15.64** Besides the media, families and other organizations will also want this information.~~

MRO follow-up actions

6.15.6750 Careful accounting for survivors after they have been delivered to a place of safety remains important. They need to be kept informed about plans for them and about the ongoing response operations. With large numbers of persons often staying in different places, keeping track of and working with them can be difficult. ~~6.15.68~~ If the incident has involved a passenger ship or aircraft it is important to work closely with the company involved as they may be able to provide considerable assistance. The company is usually ~~Transportation companies are often best suited to handle and~~ assist survivors during this time. ~~6.15.71~~ ~~To protect passengers~~ Survivors should be protected from harassment by the news media or the general public. ~~interviewers and cameras, survivors may be placed in hotels or other places of refuge. However, triage and landing locations must be established and publicized to all rescue personnel and good Samaritans.~~

~~6.15.69~~ Crew members may be placed at various locations to record passenger names and locations. Another possibility is for airlines or passenger ships to attach plastic cards to life vests to give passengers phone numbers for contacting the company. Some companies use bar coded bracelets to track children who are passengers.

6.15.7051 Communicating with ~~passengers~~ survivors is more difficult in remote areas where phone service may be inadequate or lacking. Communications systems will need to be supplied. ~~If phones do exist, calling the airline or shipping company may be the best way to check in and find out information.~~ In more populated areas, local agencies may have an emergency evacuation plan or other useful plan that can be implemented in support.

6.15.65 52 It is very important to ~~develop and share lessons learned from~~ identified in actual MRO operations and exercises. ~~However, e~~ Concerns about legal liability (often excessive), may discourage staff from highlighting matters that could have been improved. ~~6.15.66~~ Since lessons learned but sharing experience can help prevent recurring serious mistakes recurring, or can otherwise improve response in the future. Agreement should be reached among principal participants on how lessons learned identified can be depersonalized and made widely available. Lessons learned from MROs should be shared not just locally, but internationally. See chapter 9 for more information.

[...]

Add new Section 6.16

6.16 Search and rescue within areas remote from SAR facilities

6.16.1 A key to success when responding to a SAR mission in areas remote from SAR facilities is to develop a SAR Response Plan which presents agreed procedures in its area of responsibility. This plan relies on assets available in the area. The SAR plan should also describe if there are seasonal variations to consider so as to identify the basis of the response endeavor.

6.16.2 Within the areas remote from SAR facilities, the SAR authority should describe the availability of suitable infrastructure and facilities, capable of supporting a SAR response (e.g. airports/bases, sea ports, fuel facilities, landing locations, places of safety."

6.16.3 SAR routines and SAR planning should be proactively prepared by the responsible RCC for efficient SAR operations in areas remote from SAR facilities.

- 6.16.4** It is important that RCCs should be aware of the SAR resources available in regional and neighbouring RCCs, and arrange regular exchange and update of such information including details about SRUs (aircraft, vessels, land and specialized units), airstrips, refuelling and other facilities.
- 6.16.5** If a passenger ship intends to operate in an area remote from SAR facilities, the RCC responsible for that area should establish a relationship with the Company and any other organizations involved in planning an emergency response in addition to obtaining the basic SAR cooperation plan, to assist in case of an emergency. The responsible RCC should also encourage the Company to provide information regarding the ship's position and intentions while the ship is operating in the area.
- 6.16.6** All operators working in areas remote from SAR facilities should be encouraged to advise the responsible RCC of the location(s) of their operations and their capabilities to assist in case of an emergency.
- 6.16.7** RCCs in adjacent States should conduct SAREXs with each other with regard to areas remote from SAR facilities. Such SAREXs need not be complex but simple dialogues and coordination exercises to foster an understanding of how each RCC may help the other, including operations across SRR boundaries or lines of delimitation. It is important that information is exchanged between neighbouring States' RCCs about SAR data formats and interpretation of such data, for example drift modeling outputs and any other computer applications that may assist each other.
- 6.16.8** The RCC should support the ACO, OSC and other rescue personnel in assessing risks, identifying hazards and response options, and other relevant factors of importance when participating in SAR missions in areas remote from SAR facilities.
- 6.16.9** The SMC should take into consideration in SAR missions within areas remote from SAR facilities the limitations of communications due to lack of infrastructure, weather conditions, long distances and topography. Problems may occur in communications between SAR units involved in conducting such a SAR mission need to be considered. The SMC should also take into consideration every possible means of communication between units through an ACO/OSC or Air Traffic Service Unit, etc.
- 6.16.10** The SMC should be aware of the need for communication between States, especially if the SAR mission is conducted near a SRR boundary and/or the craft in distress is of different nationality.
- 6.16.11** Factors to consider when establishing the SAR response plan for areas remote from SAR facilities:
1. the number of people potentially at risk as the result of an incident in the area;
 2. the total recovery capacity of SAR facilities available to reach the scene of the incident and recover those at risk within survival times;
 3. the nature of the risk and whether containment strategies can mitigate its effects to enable those at risk to survive until rescued;
 4. the availability of SAR facilities and other resources which may be deployed in order to contain the incident and assist those at risk until rescued;

5. the distance (in time) between individual SAR facilities starting points and the scene of the incident;
6. the terrain, weather and sea conditions;
7. any restrictions on SAR facility deployment and their ability to respond even if theoretically within reach of the scene of the incident;
8. the survival time in the prevailing terrain and/or weather and sea conditions;
9. the capability of available SAR facilities to rescue those at risk in the prevailing terrain and/or likely weather and sea conditions;
10. availability and quality of communications; and
11. the ability of tasked SAR facilities to provide mutual SAR response assistance if an emergency occurs to a deployed SAR facility.

6.16.17 Care of Survivors

6.16.17.1 After rescue, survivors may require hospital treatment. This must be provided as quickly as possible. The SMC should consider having ambulance and hospital facilities ready.

6.17.2 Where there are survivors with different medical needs, and in mass rescue operations, a triage system should be used. Triage is the sorting and classification of casualties to determine the order of priority for treatment and transportation. There are many different triage systems already in use. For example, casualties are often classified into four categories, as follows:

Priority I: Immediate care

Priority II: Delayed care

Priority III: Minor care

Priority IV: Deceased

6.17.3 Triage of casualties should include the use of casualty identification tags or cards to aid especially in the sorting of the injured and their transportation to medical facilities. Casualty identification tags should be standardized through priority numbering and colour coding to make them suitable in multilingual situations. The following coding is widely used:

Priority I / immediate: a RED tag or card, with Roman numeral I

Priority II / delayed: a YELLOW tag or card, with Roman numeral II

Priority III / minor: a GREEN tag or card, with Roman numeral III

Priority IV / deceased: a BLACK tag or card, with Roman numeral IV

6.17.4 Tags or cards should be usable under adverse weather conditions, and be water resistant. Coloured light sticks or reflectors are also useful. A card can be used to supply basic information about the casualty, if time permits: identification details, injuries observed, treatment given, etc. If tags or cards are not available, prioritization can be indicated by marking the appropriate Roman numeral on adhesive tape, the casualty's clothing or exposed skin.

6.16.17.2.5 SAR personnel must ensure that, after rescue, survivors are not left alone, particularly if injured or showing signs of hypothermia or of physical or mental exhaustion.

Re-number subsequent paragraphs 6.16.3, 6.16.4, 6.16.5 and 6.16.6 accordingly

6.1718 Debriefing of Survivors

6.1819 Handling of Deceased Persons

6.1920 Critical Incident Stress

Renumber section 6.20 as shown and correct last line as shown (Chapter 9 instead of 8):

6.2021 Termination of rescue

without delay. Chapter 89 provides guidance on conclusion of SAR operations.

Chapter 7 – Multiple Aircraft SAR Operations – General Guidance (Amendment related to multiple aircraft operations)

7.1 Overview

7.1.1 The information in this chapter provides guidance for the management and conduct of multiple aircraft SAR operations. Any of the described principles and procedures might have to be modified by SMCs, ACOs and SRUs, in order to deal with specific situations. Further information on multiple aircraft SAR operations is available in IAMSAR volume III, section 5.

7.1.2 Flight safety is a primary concern during any mission involving multiple SAR aircraft. SAR aircraft should be able to operate effectively and only the aircraft necessary for the mission should be involved.

SAR Plans

7.1.3 Whenever multiple aircraft are involved in a SAR operation, there are additional risks to consider and operations should be coordinated. To overcome these risks, SAR authorities should establish plans for multiple aircraft SAR operations. For reasons of safety and the effectiveness of operations, it is important that common procedures are used in SAR plans to ensure the safe flow of aircraft during these operations. If possible, these plans should be harmonized between neighbouring SRRs (see also IAMSAR Volume I Chapter 6).

7.1.4 SAR authorities are recommended to share their experiences of multiple aircraft SAR operations with recommendations to improve SAR plans and documents.

Number of SAR aircraft required

7.1.35 In any SAR operation, SMCs should consider the capabilities and the number of aircraft required. Too few aircraft in an operation might prove fatal for persons in distress, while too many can be difficult to organize and, increase pilot workload and the risk of collisions. Other factors that might affect the number of aircraft required include the number of casualties, the carrying capacity of participating aircraft, weather conditions on scene, the distance of persons in distress from rescue facilities, the number of evacuation points, the speed at which an evacuation can take place, the speed of participating aircraft, the availability of refuelling facilities, the duration of an operation, aircrew fatigue and other operational factors. Where more aircraft than needed are available some can be held in reserve.

Aircraft Capabilities

7.1.46 SMCs should consider how to match different aircraft capabilities to the circumstances and tasks required. For instance, fixed-wing aircraft might be excellent communications platforms and able to carry out searches and ACO duties, but are not capable of rescue hoist operations. SAR helicopters are flexible in their operations, but usually cannot fly as fast, as far, or as high as fixed-wing aircraft and generally need to refuel more often. Remotely Piloted Aircraft (RPA) might have useful reconnaissance and communications capabilities and be able to remain on scene for long periods of time, but some RPA also have a limited radius of operations. In general, for safety reasons, aircraft flown by aircrew and RPA should be kept well apart unless the RPA operator and the aircrew are following agreed operating parameters established in their common State regulations.

7.1.57 SAR plans for multiple aircraft operations should be designed to achieve the most effective blend of aircraft and surface unit capabilities for the situations that are anticipated. SAR plans should aim to achieve continuous and efficient use of aircraft on scene when needed, while minimizing the situations in which aircraft are airborne without a mission.

7.1.68 SMCs should consider the abilities of the crew and aircraft when planning and during operations, so that no tasks are beyond their abilities.

7.1.79 Under some conditions, SAR aircraft might not be able to operate in accordance with SAR plans. Alternative plans should be developed and agreed in advance by SMC and pilots-in-command participating in the SAR-operation. Alternative courses of action during the mission should also be agreed between them by pilot-in-command and the SMC.

Participation by ~~other~~ supplementary aircraft with SAR capability

7.1.810 RCCs may have dedicated civil, military and/or other government SRU aircraft available as part of their national SAR plans. In some situations, such as mass evacuations from offshore drilling platforms, large scale incidents over land areas etc., supplementary aircraft with SAR capability belonging to other commercial companies or other organizations might be able to respond to incidents as part of existing emergency plans. During SAR operations, it is essential that the activities of these aircraft be coordinated with the overall SAR response in order to reduce the risk of collisions and to make the overall operation safe and effective. SAR authorities and SMCs should therefore make agreements also with these commercial companies and other organizations describing how SAR operations should be coordinated, when both

dedicated SAR and other aircraft are involved. SAR authorities and SMCs should also be aware of the SAR requirements and capabilities of relevant companies and organizations in their SRRs.

Refuelling Facilities

7.1.911 Use could be made of strategically located aircraft refuelling facilities that exist within range of an incident. Examples of suitable facilities include airfields, helicopter operating facilities, offshore drilling platforms and vessels that can refuel aircraft. SMCs should also consider deploying mobile aircraft refuelling facilities closer to distress locations to facilitate more effective SAR operations, including faster turnaround times to return to distress locations, especially in helicopter operations.

Debriefing of SAR mission

7.1.1012 Whenever a multiple aircraft SAR operation has taken place, a debrief should be held soon afterwards. The debrief should normally be conducted by the RCC in overall charge of coordinating the SAR operation. The debrief should include all the relevant units involved in the operation and record observations, lessons learned and recommendations to improve future SAR plans and operations.

7.2 Area of SAR action

7.2.1 During multiple aircraft SAR operations, SAR aircraft involved should be able to operate free from interference from other aircraft and operations. Additionally, aircraft that are not involved in a SAR operation need to be informed of the SAR operation and any temporary airspace reservation or flight restrictions. SAR authorities should ensure that suitable, temporary areas are agreed in order to protect SAR operations, unless suitable areas are already available.

Definition

7.2.2 The term "area of SAR action" is derived from ICAO procedures for air navigation services (PANS-ATM). An area of SAR action is an area of defined dimensions that is established, notified or agreed for the purposes of protecting aircraft during SAR operations and within which SAR operations take place. There should be an arrangement in place for SMCs to establish an "area of SAR action".

Establishing Areas of SAR Action

7.2.3 SAR authorities should make arrangements to establish temporary airspace reservation, danger areas, restricted areas or other suitable categories of area through appropriate State authorities. These areas should be agreed and put in place as early as possible during a multiple aircraft SAR operation. The guidance for SAR aircraft flying within areas of SAR action are described later in this section. For situations in which areas cannot formally be established to protect SAR operations, see paragraph 7.2.10.

7.2.34 The dimensions of the required area of SAR action depend on the circumstances and can be different over land compared to maritime operations. In general, the horizontal and vertical dimensions of an area of SAR action should be large enough to enable safe operations for SRUs, taking into account the need for airborne SRUs to safely manoeuvre throughout their mission profile. SAR plans might involve procedures in which different altitude levels are assigned to different aircraft. This is an important

consideration whenever any combination of fixed wing aircraft, helicopters and RPA are operating in the same area. Factors to be taken into account when considering the dimensions of areas of SAR action include the following:

- (a) The required extent of SAR activities, including searching.
- (b) The need for multiple aircraft to manoeuvre safely.
- (c) The need to protect SAR aircraft from other types of operations.
- (d) The impact that SAR activities might have on other, neighbouring activities.

SAR Operations within Controlled Airspace

7.2.45 If multiple aircraft SAR operations take place within controlled airspace, then either the ATS should control SAR aircraft in accordance with normal ATS procedures or an agreed portion of airspace should be temporarily handed over for coordination by an ACO.* The ATS unit involved may also be in a position to carry out some of the duties of an ACO.

~~* This procedure might also involve the establishment of restricted or danger areas and the temporary suspension of controlled airspace.~~

Entry to Entering Areas of SAR Action

7.2.56 SAR aircraft intending to enter an area of SAR action should not enter the area until the ACO relevant unit (RCC, ACO, OSC or responsible ATS unit) gives them permission approval and provides them with sufficient information to safely join the flow of SAR aircraft involved in the operation (see also paragraph 7.4.2). Aircraft should call the ACO relevant unit as early as possible before entering the area, in order to allow time for information to be exchanged and in case they are required to remain clear of it. As a general guide, aircraft should aim to make contact get in touch with an ACO when at least ten minutes' flying time from the edge of an area of SAR action and pass entry information using the format described in appendix T. In the event that an area of SAR action has been established but an without an ACO is not yet available, SAR aircraft should receive information that they require primarily from the coordinating RCC or OSC.

Leaving Areas of SAR Action

7.2.67 Aircraft leaving areas of SAR action should contact the relevant unit ACO before the area boundary and before changing to another frequency. Aircraft leaving should use the format described in appendix T.

Flights in Areas of SAR Action by Other Aircraft

7.2.78 Aircraft that are not involved in a SAR operation should normally not fly within areas of SAR action. However, if such aircraft need to enter an area of SAR action, they should do so only with the approval of a SMC, ACO, OSC or coordinating ATS unit and are subject to the rules of the area or the relevant class of airspace. If a SMC or coordinating ATS unit is giving approval, the ACO or OSC should first be consulted.

Alerting Service for SAR Aircraft

- 7.2.9** SAR plans should consider providing alerting service for SAR aircraft operating in the Area of SAR Action. Although this may normally be provided by the ATS unit responsible, the provision of this supplementary service by OSCs or ACOs may assist ATS to reduce their workload, reduce frequency congestion and maintain communications in areas of poor ATS radio coverage. It should also be considered for SAR aircraft operating in areas where no ATS is provided. OSCs or ACOs may maintain SAR alerting watch using entry/exit and on-scene scheduled reports by SAR aircraft.

When Areas of SAR Action cannot be Agreed or Used

- 7.2.10** It might not always be possible to formally agree or use an area of SAR action. In such situations, SAR authorities, SMCs/OSCs, ACOs and SRUs should, in cooperation with affected ATS units, agree suitable coordinates and dimensions within which agreed SAR flying procedures should take place. Within these coordinates and dimensions, even if no area of SAR action formally exists, procedures for multiple aircraft operations should still be applied and flown by the aircraft involved, provided that these can be carried out safely.

7.3 Aircraft coordinator (ACO)

Purpose of an ACO

- 7.3.1** The purpose of an ACO is to contribute to flight safety and to perform an efficient SAR operation. The ACO should have a clear understanding of the aim of the SAR operation. ACOs should be prepared and able to coordinate SAR aircraft tasked by an SMC. Particular attention should be paid to aircraft that are likely to operate close to each other.

ACO Qualifications and Training

- 7.3.2** ACOs fulfil a vital function during SAR operations and their duties can be complex and require specialist knowledge. Therefore, ACOs need to have experience of relevant operations and/or exercises and be specially prepared for their duties. In order to ensure the best standard of SAR operations and safety, people likely to be designated as ACOs should be specially trained to carry out this duty. Once trained, SAR authorities should ensure that exercises take place to train ACOs and to practice multiple aircraft operations. RCCs should be aware of trained ACOs in their SRRs and establish procedures for tasking them whenever they might be needed for a SAR mission.

Responsibility for Safety

- 7.3.3** The safety factors for aircraft involved in a SAR operation should first be assessed by the SMC or the OSC in consultation with SAR aircraft pilots-in-command. Assessment procedures should be used to assist decisions regarding safety of operations including risk inputs such as number and performance of aircraft, capacity for aircraft pilots to deconflict from other aircraft, accuracy of aircraft navigation capability, manoeuvring requirements, wake turbulence, current and forecast weather, sea conditions, terrain, time of day and other applicable risk factors (environmental, aircraft, airspace, other air traffic and location).

Information from ACOs to aircraft on scene is advisory, but should nevertheless be followed as closely as practicable. If necessary to ensure flight safety, aircraft pilots-in-command should take whatever measures they assess are needed. If they decide to ~~aircraft pilots-in-command~~ deviate from advice passed by an ACO, or observe any potential hazard to flight operations, then they should inform the ACO as soon as possible. **The final decision concerning the safety of an aircraft, its crew and passengers rests with the pilots-in-command of the aircraft involved.**

ACO Duties

7.3.4 Procedures, duties and tasks involving ACOs are described throughout this Section. A list of normal duties for an ACO, also contained in IAMSAR Volume III, can include the following tasks:

- (a) Contributing to flight safety:
- ~~m~~Maintain a safe flow of aircraft
 - ~~e~~Ensure use of a common altimeter setting for all aircraft involved
 - ~~a~~Advise the SMC/OSC of on-scene weather implications
 - ~~d~~Determine a direction for entering and leaving areas of SAR action
 - ~~d~~Determine all points necessary for maintaining a safe flow of aircraft within the area of SAR action
 - ~~f~~Filter ~~Manage~~ radio messages to and from SAR aircraft
 - ~~e~~Ensure frequencies are used in accordance with SMC directives
 - ~~e~~Coordinate with adjacent air traffic services (ATS) units
- (b) Prioritizing and allocating tasks:
- ~~e~~Ensure SAR aircraft are aware of the SMC/OSC overall plan and their own tasks
 - ~~m~~Monitor and report search area coverage
 - ~~w~~With appropriate SMC/OSC, identify emerging tasks and direct SAR aircraft to meet them
- (c) Coordinating aircraft operations:
- ~~r~~Respond to changing factors on scene and supervise effectiveness of operations
 - ~~e~~Ensure the continuity of aircraft operations in coordination with SMC/OSC
 - Monitor and keep SMC/OSC informed about the progress of tasks assigned to SAR aircraft

- (d) Informing SAR aircraft (note also 7.3.3 Responsibility for safety):
 - Assign tasks to aircraft
 - Distribute relevant flight information
 - ~~– safety information to aircraft (see subparagraph (a) above)~~
 - Provide information about relevant air activity and dangers on scene
 - Provide information about search areas (if applicable) evacuation points (if applicable) and refuelling facilities
 - Provide operational information about the ongoing SAR-mission
 - Provide relevant weather information
- (e) Make periodic situation reports (SITREPs) of SAR aircraft operations to the SMC and the OSC, as appropriate.
- (f) Work closely with the OSC:
 - ~~a~~ Assist in the execution of SMC directives
 - ~~m~~ Maintain communications
 - ~~a~~ Advise on how the ACO can assist
- (g) Coordinate aircraft refuelling.

Designating an ACO

- 7.3.5** Whenever ~~two or more~~ multiple aircraft are taking part in a SAR operation and are likely to operate close to each other, SAR authorities should consider designating a person, unit or organization as an ACO.
- 7.3.6** An ACO is designated by a SMC and should carry out missions under a SMC's direction. ~~SMCs should consider designating an ACO as soon as they recognize that a SAR incident might need a response from two or more aircraft.~~ ACOs should be notified of their mission as early as possible, in order to give them the maximum time to prepare for their tasks.
- 7.3.7** There are many factors for SMCs to consider when designating an ACO, however, some significant considerations are as follows:
- (a) Designating an ACO should be considered when ~~two or more~~ multiple aircraft are involved in a SAR mission.
 - (b) An ACO should be equipped with appropriate forms of communication for the SAR mission, such as the appropriate radios for communicating with aircraft, ~~with~~ ATS units, ~~with~~ SAR authorities and ~~with~~ SRUs on the surface. ACO situational awareness can also be assisted by equipping with surveillance capabilities such as ADS-B, AIS or other flight tracking capabilities.

- (c) An ACO should clearly understand the overall objective of the SAR operation and relevant SMC plans.
- (d) ACOs should be provided with sufficient information to carry out their mission or have access to sufficient information.
- (e) An ACO should know which authority to report to (normally a SMC) and which other units are involved in a mission.
- (f) ACOs should be able to reach the required location in sufficient time for them to prepare for and carry out their duties.
- (g) A person or SAR unit designated as an ACO should have received appropriate training ~~beforehand~~ in advance.
- (h) An ACO should be familiar with the types of aircraft involved and their flying operations.
- (i) An ACO should be familiar with SAR operations involving multiple aircraft.
- (j) ACOs should ideally be familiar with the environment, normal procedures, activities and air traffic systems in the areas of operation.
- (k) The time that ACOs may be available to carry out their missions should be considered. If an ACO is on board an aircraft, then aircraft endurance might limit the amount of time for which that ACO can be available.

ACO Location

7.3.8 ACOs should ideally be as close to the scene of a SAR incident as practicable. However, the choice of location of an ACO is flexible, and they should operate in locations which best help them to carry out their duties, such as on a fixed-wing aircraft, a helicopter, a ship, a fixed structure such as an oil rig, an ATS unit, a coordinating RCC or another appropriate land unit.

ACO Workload

7.3.9 The workload of an ACO can be very high. SMCs should bear this factor in mind, when they are considering the total number of SRUs that might be required for a SAR operation. An aircraft or surface unit designated as an ACO might only be able to carry out the ACO mission and no other task due to high workload.

Coordination with Adjacent Facilities

7.3.10 As much as possible, SMCs should aim to reduce an ACO's workload by coordinating SAR activities taking place within an area of SAR action, with relevant ATS units, airfields and other facilities. However, depending on the location and circumstances of an incident, ACOs should also be prepared to carry out these duties.

On-Scene Altimeter Setting

- 7.3.11** A common altimeter setting should be used by all aircraft within an area of SAR action. This altimeter setting might be determined when the first SAR aircraft equipped with a radio altimeter arrives on scene. Alternatively, the on-scene altimeter setting can be determined by the ACO, in consultation with an ATS unit (when available), a SMC or an OSC (when appropriate). The ACO should pass the information to all aircraft in the area of SAR action.

Reporting On Scene Activity

- 7.3.12** The ACO should make regular reports of on scene activity to the SMC and aircraft involved in the SAR operation. When possible, these reports should be made when ACOs or aircraft are not busy with other operational tasks. The radio communications procedures described in paragraph 7.4.2 can be used for this purpose; however, other methods might also be appropriate. A general guide is for ACOs to make reports every thirty minutes during a SAR operation or when anything of significance occurs.

Information from SAR Aircraft to the ACO

- 7.3.13** In order to enhance situational awareness for ACOs and other SAR aircraft and to assist with safety and the continuity of operations, participating aircraft should report as follows:

- (a) Entry report.
- (b) Reaching assigned points.
- (c) Leaving assigned points.
- (d) Commencing operations (search, investigation during search, approach to the surface/ship, missed approach difficulties, hoist, landing etc.).
- (e) Completing operations, including information regarding results.
- (f) Leaving present altitude.
- (g) Reaching new altitude.
- (h) 30 minutes on scene endurance, expecting fuel at (location).
- (i) 10 minutes to completing hoist operation.
- (j) 10 minutes to completing search.
- (k) Exit report.

Transfer of ACO tasks

- 7.3.145** During some SAR operations, particularly those lasting for long periods of time, it may be necessary to transfer the tasks from one ACO to another. This might be due to fatigue, factors affecting an ACO's location, such as the requirement for an ACO's aircraft to refuel, or for other reasons.

- 7.3.156** Before accepting the task the new ACO should understand the details of the SAR mission operation and the SMC's plans. The details required may include the aim of the operation, the position of the missing object, number of persons in distress, other units involved, and locations of participating aircraft, communications and any limitations to the operation. When possible, basic pre-flight information should be provided by a SMC in order to simplify the transfer to the new ACO. Examples of information that might be of use to ACOs on scene can be found in are in appendix T-3.
- 7.3.167** A new ACO will need enough time to obtain information, study it and then prepare to accept the task from the previous ACO. Every SAR mission may be different, but as a general guidance, a handover of information should begin approximately thirty minutes before a new ACO formally takes over.
- 7.3.17** A change of ACO might also involve a change of ACO location. If this is the case then, upon taking over, the new ACO should make a general communications broadcast announcing the new information and, whenever possible, obtain acknowledgements from all the participating aircraft. A new ACO should inform all participating aircraft that a handover has taken place.

When to Conclude ACO Operations

- 7.3.18** A SMC is normally in charge of a SAR mission and determines which SRUs take part in it. However, in practice, an ACO is often in the best position to advise the SMC, when a SAR operation no longer requires an ACO. The decision to end ACO operations should normally be made by the SMC that designated the ACO, after consulting with relevant organizations and units.

Checklists and Guides

- 7.3.19** ACOs and SAR aircraft are recommended to use checklists or guides containing relevant information. Units who are likely to be designated as ACOs or take part as airborne SRUs in the event of a multiple aircraft SAR operation, should always have ACO checklists or guides available whenever they are on duty. Relevant information for ACOs and SAR aircraft should include procedures for planning, joining and exiting an area of SAR action, making position reports, holding, conducting searches and information about different aircraft types. Guides and checklists and guides suitable for ACOs are contained in appendix T.

Reference Information for Air Crew

- 7.3.20** SAR authorities should ensure that all air crew likely to become involved in multiple aircraft SAR operations are aware of the procedures. To help with this process, air crew should routinely operate and fly with reference information, including IAMSAR Volume III, in case they are required to take part in an operation at short notice. Additionally, an operational summary short reference list known as the "Pilot Information File" (PIF) contains useful in-flight information useful for all aircraft involved in multiple aircraft operations and is illustrated in appendix T-6 and also in IAMSAR Volume III.

7.4 Communications

ACO Call sign

7.4.1 Large scale SAR operations can involve units from different organizations or SRRs, which might not routinely work together. In order to make the identity of an ACO clear to all participating units, the standard call sign: "**Air Coordinator**" should be used by all ACOs.

Radio Voice Communications

7.4.2 There should be agreed, common, on scene procedures for the following:

- (a) On Scene Coordination Frequency. An agreed coordination frequency for radio voice communications should be used within an area of SAR action. SMCs should consider designating a dedicated SAR frequency for aircraft operations, noting 123.1 MHz has been reserved internationally for this purpose. ~~This frequency~~ The frequency selected should be one which all aircraft can access, together with the ACO. The SAR frequency in use should be included in any NOTAM or other advice to other airspace users as part of the notification about the Area of SAR Action. Information that should be passed between an ACO and SAR aircraft is listed in appendix T.
- (b) Alternative Frequencies. Alternative frequencies should also be nominated by an ACO if the agreed coordination frequency is likely to become too busy or unusable.
- (c) Capabilities. Care should be taken to ensure that aircraft and surface units involved in an operation are capable of complying with the communications procedures.
- (d) Communications with an OSC. Consideration should be given to enabling communications between an ACO and an OSC. However, it should not normally be necessary for SAR aircraft other than an ACO to communicate directly with the OSC.
- (e) Radio Communications Failure Procedures. All SAR plans for multiple aircraft SAR operations should include procedures for use when radio communications fail. A failure of radio communications might affect aircraft, SRUs or persons in distress individually, or might involve a compromise of radio systems affecting several participants. The systems affected might include radio voice communications or radio systems designed to indicate the positions of aircraft, vessels or people, including transponders and other devices. In general, the following principles should apply to most situations in which radio communications fail:
 - ~~A backup~~ Backup means of radio voice communication should be determined and then nominated by an ACO, along with the normal communications plan.
 - The backup radio voice communications might include alternative frequencies, alternative radio communications systems or both. In the event of a radio communications failure, with no alternative airborne communications available, aircraft should normally continue with their planned timings, events and flight path, still transmitting all position and altitude reports, until they are clear of the immediate on scene area.

- If an aircraft has not been given a plan when a radio communications failure occurs, then it should avoid the on scene area, departing by an appropriate route and heights.
- Once clear of the on scene area, aircraft should consider moving near or landing at a suitable facility in order to establish communications by alternative methods.

7.4.3 If radio voice communications cannot be restored, then alternative procedures could be considered such as increasing the distances between aircraft using time. If not already included in SAR plans, then all participating airborne SRUs might have to be assembled together in order for this procedure to be briefed and understood. In most cases, this would result in considerable delays to a SAR operation.

7.4.4 A diagram illustrating a basic example of communications during multiple aircraft SAR operations, involving an ACO is described in appendix T-2.

Long Range Radio Communications

7.4.5 Communications systems designed for long range SAR operations can be different from the types of communications used at shorter ranges. Types of radio equipment that relies on direct "line of sight" between a transmitter and receiver may not be suitable for long range communications between SMCs and SRUs. ~~Some~~ Long range communications methods include the following:

- (a) High Frequency radio systems.
- (b) Satellite communications systems.
- (c) Position tracking systems, including those that enable two-way communications.
- (d) The use of high flying aircraft to relay VHF radio communications to and from lower flying SAR aircraft.
- (e) Relay of information to and from SAR aircraft through ATS units.
- (f) Relay of information by ships at sea able to communicate with SAR aircraft on marine band VHF frequencies, whilst a shore based RCC uses satellite, MF or HF communications to communicate with the relaying ship(s).
- (g) Relay of information by any surface units able to communicate with both SRUs and SMCs.

SAR Aircraft Surveillance Equipment

7.4.6 To assist SAR aircraft pilots with situational awareness of other aircraft and vessels in the Area of SAR Action, the use of SAR aircraft fitted with surveillance equipment such as Traffic Collision Avoidance System (TCAS), ADS-B and AIS should be considered. All aircraft operating within and adjacent to an area of SAR action should operate with the transponder on.

7.5 Search mission

7.5.1 The most likely situations in which multiple aircraft might be involved in searches is when large areas need to be searched in which the confidence of the datum position is low. The procedures described below generally assume that visual search techniques are used. However, other technical devices and/or techniques might also be required or SAR aircraft might only be able to locate persons in distress by homing onto transmissions from emergency distress beacons, transponders or other devices. In these situations the use of multiple SAR aircraft should be considered carefully in conjunction with risk assessment procedures to ensure flight safety including assisting pilots-in-command with their management of deconfliction from other aircraft.

Safety and Search Effectiveness

7.5.12 ~~ACO and SAR aircraft should use procedures that ensure flight safety, without making the search ineffective, should be used.~~ Procedures that ensure flight safety, without making the search ineffective, should be used. Aircraft should be given sufficient operational freedom to carry out their searches effectively, but should conform to safety procedures provided ~~briefed~~ by the RCC, ACO, OSC or ATS.

7.5.23 Methods used to safely keep aircraft apart will depend on the on scene conditions. Beginning with good weather conditions and progressing to poor conditions, methods for keeping aircraft apart to enhance flight safety are ~~can be~~ as follows:

- (a) Visual Methods.
- (b) Flow Methods.
- (c) Coordination Zones.
- (d) No Fly Zones.

Visual Methods

7.5.34 Visual methods involve the ~~ACO allocating~~ ~~on of~~ aircraft to search areas and aircraft avoiding each other visually. Visual methods may be the only measure necessary when weather conditions on scene are good. When using visual methods, the RCC, ACO or OSC can allow aircraft more freedom of action compared to other, more restrictive, methods. However, this freedom will not relieve the need to operate with due regard to other flight information and reporting requirements as outlined earlier in this section. ~~aircraft or ACOs from other duties outlined earlier in this section, for example providing information on air activity or making aircraft reports.~~

Flow Methods

7.5.45 Flow methods can be used to assist keeping SAR aircraft apart in slightly poorer conditions, by ensuring that they fly the same search patterns (commence search point CSP/~~line of advance~~ direction of creep, etc.) but in relative to adjacent search areas. The first aircraft on scene should be allocated the search area furthest away from the ~~line of advance~~ direction of creep. This method generally enables aircraft to execute effective searches of areas with a minimum of radio communication. Aircraft can also be kept apart by using time. This method could be used if aircraft arrive on-scene at considerably different times, for example as a result of departing from different base locations. All aircraft should still be very well informed of each other to avoid any conflicts, particularly for small track spacings and with high performance aircraft turning circles at high speeds before rejoining search legs.

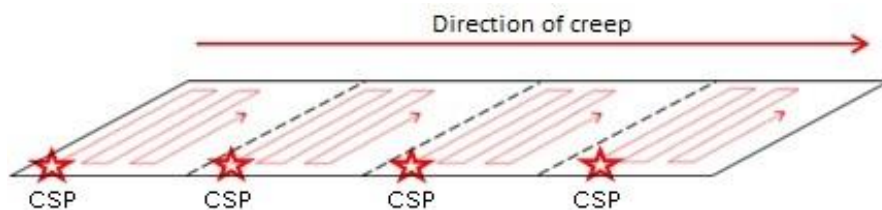

7.5.56 The ACO may order s Specific different search altitudes may be assigned for SRUs, to allow an extra margin of safety when aircraft operate in close proximity to each other. However, in this situation the ACO should be aware that any limit to the operational freedom of an aircraft, particularly in altitude, could reduce the effectiveness of the search may be compromised. The ACO should also expect An additional consideration is that aircraft may need to deviate from their assigned altitude if they need to investigate objects on the surface or drop SAR supplies. ACOs should ensure that a All aircraft should use the same reference for altitude.

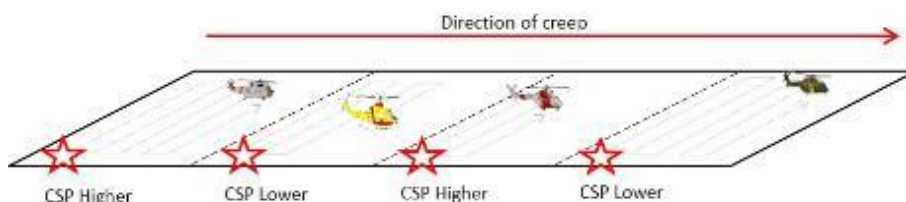

Coordination Zones

7.5.67 Coordination zones are border areas established by an ACO between adjacent search areas, which SAR aircraft can only enter under specific conditions. Coordination zones enable aircraft to have operational flexibility within their allocated search areas and ensure a level of safety between them.

7.5.78 The dimensions of a coordination zone depend on the on-scene conditions and the size of a search area. As a general guide, a coordination zone might be 2 nautical miles across, but this size may be increased or decreased if needed. Allowance for aircraft turns at the end of search legs needs to be considered especially for high speed aircraft. Before entering a coordination zone, aircraft sharing the zone should communicate with each in order to safely coordinate the entry. The ACO, OSC or RCC should ensure that the aircraft have a clear understanding of their mutual operating areas. The aircraft should call again when leaving the zone.

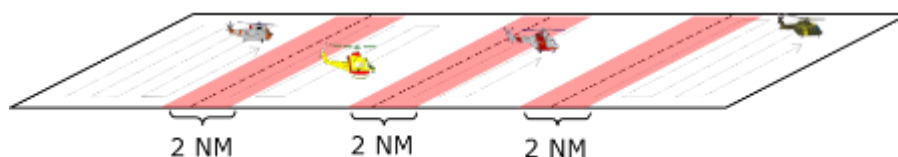

No Fly Zones

7.5.89 If on scene conditions are sufficiently difficult, no fly zones can be used in which flight is not permitted while searching is taking place in adjacent areas. The dimensions of no fly zones can be similar to coordination zones. Whenever no fly zones are used, the ACO should coordinate with the SMC and OSC to ensure that the no fly zones are searched appropriately during the SAR mission operation.

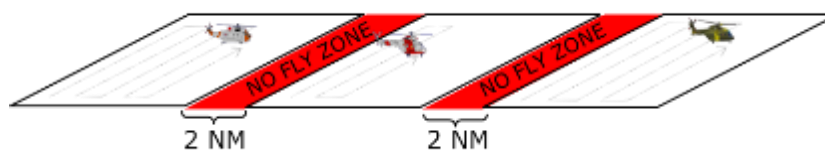

Investigation of Sightings

7.5.10 Sightings of potential search objects in the search area may require investigation by SAR helicopters and/or fixed wing aircraft. This may involve the rescue of survivors, recovery of bodies or retrieval of debris or other objects. Procedures within an area of SAR action will also need to allow for all participating aircraft to safely manoeuvre during these operations.

7.6 Evacuation missions

Safety Flow Procedures

7.6.1 The main aim of on scene procedures for multiple SAR aircraft operations should be safety. In general, there are two methods that can be used to ensure a safe flow of SAR multiple aircraft, which are as follows:

- (a) Horizontal Spacing. Horizontal spacing of aircraft operating visually should be the basic method used by SAR authorities and ACOs. It can be achieved by establishing coordinated specific routes to be flown by SAR aircraft to, from and within the area of SAR action.

The minimum components should include:

- A direction for entering and leaving the area of SAR action.
- Entry and Exit points.
- Adequate horizontal spacing between individual search areas.
- Same alignment of search legs and direction of creep.
- Timed entry and exit from individual search areas.

- (b) Vertical Spacing. For situations in which keeping aircraft apart horizontally will not ensure sufficient levels of safety, or if a cross-over of aircraft flight paths cannot be avoided then, when weather permits, vertical spacing should be considered. It may not always be necessary for SAR aircraft to fly at different altitudes, unless they are likely to fly close to each other or their flight paths cross over. If a significant possibility of collision exists, then different altitudes should be assigned for SAR aircraft. Vertical spacing of aircraft can be used in combination with horizontal spacing for aircraft operating visually but is a key consideration for safety during poor weather conditions when more segregated operations are likely to be required.

- (c) In general, altitudes for RPAs should be kept apart from altitudes allocated for other SAR aircraft.

7.6.2 ~~Ideally, the most e~~ An effective method to ensure a safe flow of aircraft is by using a combination of both horizontal and vertical spacing. The best way to achieve this is through planning by ~~an~~ the ACO, OSC or RCC and a clear understanding of procedures by all of the units and authorities involved.

7.6.3 The procedures used by SAR aircraft within an area of SAR action should be determined by the ACO in consultation with the SMC/OSC and pilots-in-command of the SAR aircraft. The use of assigned flight paths, coordinated timings and designated entry and exit procedures will help to ensure a safe flow of SAR aircraft. These can be determined by using bearings and distances from features such as the casualty location, or described using coordinates such as Latitude and Longitude. An effective way to organize multiple SAR aircraft engaged in an evacuation operation is to use procedures based on a central reference position (for example a vessel in distress).

7.6.4 Aircraft evacuation and rescue missions will generally involve helicopters, however fixed-wing aircraft may also be involved in supporting these operations, for example during SAR supply dropping operations. Procedures within an Area of SAR Action should provide for these types of operations including allowance for safe manoeuvring during drop patterns.

Aircraft Approach and Departure Flight Paths

7.6.35 Approach and departure flight paths are usually influenced by the prevailing wind direction; factors which might also have to be taken into account are:

- (a) Fumes directly downwind from burning structures may be unsafe – the direction of approach for aircraft might have to be off-set from the wind direction.
- (b) Geographic features or the design of the casualty location might compel aircraft to approach only from specific directions. Structures such as cranes, towers or vertical obstructions in line with the wind direction, might be dangerous as physical obstacles or due to mechanical turbulence created downwind.
- (c) ACOs and SAR aircraft should be ~~aware~~ informed of all surface vessels, installations or other obstructions in the approach and departure sectors and plan to avoid them.
- (d) Approach Fallback Procedures – (see 7.6.8).

7.6.6 *Additional Considerations for ACOs.* The ACO should work together with the SMC, OSC and SAR aircraft pilots to minimize the periods with no aircraft at the location of persons in distress. This process needs to be managed carefully in order to ensure that all participating aircraft are aware of each other and safety and deconfliction is assured.

Instrument Based Procedures

7.6.7 When weather conditions are so poor that flying operations cannot effectively be carried out according to visual procedures and the procedures described earlier in this chapter, then it might be possible for an aircraft to operate under instrument based procedures in an effort to establish visual conditions in the area of SAR action. Unless published procedures already exist to and from the vessel or platform in distress (such as an offshore energy installation) then the use of instrument based procedures during a multiple aircraft SAR operation may not be feasible and in order to provide appropriate safety margins for aircraft involved. A segregated operation may be required where only one aircraft can follow instrument based procedures below a certain level in the area of SAR action at a time. Unless operations are carried out in controlled airspace under the full control of an ATS unit, aircraft pilots-in-command are responsible for avoiding other air traffic and surface obstructions in accordance with established regulations of their State for operations in Instrument conditions and transitioning to visual conditions.

7.6.8 *Approach Fallback Procedures.* If on scene conditions in an area of SAR action prevent a SAR aircraft from successfully completing an approach to the distress location, then an Approach Fallback Procedure should be flown in order to safely rejoin the flow or depart from the area. Approach Fallback Procedures must be briefed to all SAR aircraft by an ACO. The on-scene workload of ACOs can be reduced if suitable procedures are described in SAR plans in advance.

7.6.9 If aircraft are required to hold adjacent to the distress location in non-visual conditions whilst another aircraft is operating on scene, then vertical spacing should be used for safety purposes. Additional vertical spacing may be required where turbulence impacts aircraft ability to safely hold an altitude.

7.7 Long range operations

7.7.1 Long range is any distance that significantly limits or compromises the ability of SAR aircraft to operate on scene effectively and safely.

Long Range Procedures

7.7.2 When flying long distances, SAR aircraft should attempt to reduce fuel consumption while in transit, to provide for more additional time on scene. It might be necessary for SAR aircraft to fly as directly as possible to and from an incident, with the result that multiple aircraft SAR procedures have to be modified and rely on basic safety arrangements. These arrangements could include separate arrival times on scene and basic inbound and outbound height differences in order to keep aircraft safely apart. Additional considerations for long range SAR communications are described in paragraph 7.4.5.

7.7.3 The risks to SRUs during long range SAR operations should be considered carefully before long range SAR operations take place, including the following:

- (a) Overall urgency to save life.
- (b) Range Distance offshore or from suitable aerodrome or helicopter landing site.
- (c) Nature of the mission.

- (d) Performance characteristics and technical limitations of aircraft taking part in the mission.
- (e) Communications.
- (f) Availability and effectiveness of flight following equipment: satellite tracking; ATS radar picture, etc.
- (g) Likelihood of locating the relevant person in distress, vessels or platforms.
- (h) The risk to SRUs in the event of an accident.
- (i) Current and forecast weather conditions en route and on scene.
- (j) Sea state/swell.
- (k) ~~The~~ Available daylight and amount of darkness on scene (at night).
- (l) Size, shape and characteristics of the casualty vessel, platform or location.
- (m) Location of persons in distress on a vessel (e.g. should they be moved to a suitable position for rescue hoist operations).
- (n) The proximity of refuelling facilities to the persons in distress.
- (o) The availability of diversions or locations for temporary landing (e.g. offshore energy installations, etc.).
- (p) Aircrew capabilities or skill levels.
- (q) Aircrew fatigue.

Bringing a Casualty Vessel Within Range

7.7.4 If the casualty is on a moving vessel, SMCs should consider the possibility of ~~directing~~ requesting it to move to a point within the effective range of SAR aircraft or other forms of assistance. Alternatively, it might be possible for SAR aircraft to refuel at locations that effectively bring a casualty within their maximum radius for SAR operations. It could also be effective for SMCs to use both of these options at the same time.

7.8 Effects of the environment and weather

7.8.1 Factors such as the type of environment and weather can significantly affect the conduct of multiple aircraft SAR operations. It is important that SAR authorities establish plans that contain procedures for all of the weather conditions likely to be encountered. As a general principle, it is usually better to plan for poor conditions and to then modify procedures if better conditions permit. As weather and environmental conditions become worse, the risks for both the persons in distress and rescuers increase and the speed at which SAR operations can take place becomes slower.

- 7.8.2** Some weather conditions might prevent certain types of SRU from operating, while other types of SRU can still continue. For example, conditions such as very poor visibility at sea might limit or prevent airborne SRUs operations, but might not prevent surface rescue craft from operating. Heavy seas might make ship to ship transfers of persons in distress unacceptably dangerous, while helicopter hoist operations can continue. Poor weather conditions at airfields, places of safety, along coastlines or along an intended route can affect SRUs and prevent them from departing for, or fulfilling their SAR missions.
- 7.8.3** In extreme situations the risks to SRUs and persons in distress of attempting a SAR operation might be sufficiently high that operations cannot take place at all, until conditions improve. There are many factors that can affect multiple aircraft SAR operations; several of the more common ones are outlined below.
- (a) *Wind Direction – General.* Wind direction can have a strong influence on search patterns flown by aircraft and the directions of approach and departure by aircraft to persons in distress. Generally, approaches and departures by aircraft are flown into wind. Geographic features, characteristics of the casualty vessel or structure, might mean that approach and departure directions have to be modified. Additionally, if the location of persons in distress is on a burning structure, then smoke and fumes may be dangerous. ~~A~~ and airborne SRUs should avoid flying directly downwind of the source. The wind direction might have a significant influence on a SAR operation and multiple aircraft SAR procedures should be designed with this principle in mind.
 - (b) *Strong Winds – Maritime Operations.* Strong winds can present significant difficulties for aircraft, whether operating on their own or together with other aircraft. During maritime operations, rescue attempts from surface vessels with large amounts of movement (**heaving and rolling**) due to heavy seas can be extremely dangerous. Strong winds and high sea states can affect even the largest vessels, sufficiently to prevent helicopters from landing on helicopter decks. Strong winds can also make rescue hoist operations extremely difficult. Air turbulence downwind of large vertical structures such as offshore platforms, wind farms or the superstructures of large vessels and large topographical features with high elevations such as islands / rock features can be dangerous for aircraft operations.
 - (c) *Strong Winds – Moisture and Atmosphere.* Strong winds can significantly affect transit times for aircraft and might limit the ranges at which they can operate. Moisture from the sea can be stirred up into the atmosphere at least 1000 ft above sea level. This moisture can decrease visibility and in very cold conditions can cause ice to build up on aircraft structures. Moisture that has a high salt content can also reduce aircraft engine performance enough to limit the amount of people and cargo that can be carried and make aircraft operations unsafe.
 - (d) *Strong Winds – Over Land Operations.* Strong winds over land can result in turbulence in the air that is dangerous for aircraft. Turbulence can be particularly severe in mountainous areas, near cliffs and for significant distances downwind of hills and mountains. In very strong winds, horizontal visibility is usually reduced; this is most noticeable both in and downwind of dry, dusty regions such as deserts. A similar, but usually more local affect can take place in snow-covered regions. Multiple aircraft SAR operations can be significantly affected by such events and may not be able to take place at all until conditions improve.

- (e) *Low Cloud and Poor Visibility.* Low cloud can reduce visibility and restrict the amount of altitude in which SAR aircraft can manoeuvre. Low cloud and poor visibility also reduce the effectiveness of SAR operations or even prevent them altogether.
- (f) *Adjusting SAR Plans.* Some SAR authorities have plans for multiple aircraft operations that enable them to operate in conditions of poor visibility, sometimes relying on ATS units and good levels of training. During maritime operations, some aircraft are themselves capable of finding and flying to vessels in conditions of very poor visibility. This procedure may only be possible if carried out by aircraft and aircrew capable of this type of flying. At the very least, poor visibility will significantly slow down the speed at which multiple aircraft operations can be conducted, compared with operations in good weather. In many situations, low cloud and poor visibility may prevent multiple aircraft SAR these operations from taking place at all, until conditions improve.
- (g) *Darkness.* During darkness distances are more difficult to visually assess than during daylight and aircraft often need to maintain greater horizontal and vertical spacing from each other.

Night Vision Devices

- 7.8.4** Night vision devices are often being worn by SAR aircrew, as they can compensate for the effects of darkness. When used appropriately, night vision devices significantly improve safety and effectiveness over land as well as in coastal and maritime operations.
- 7.8.5** Although using night vision devices can improve multiple aircraft SAR operations, these devices can be affected by the weather conditions at night in a similar way that visual flying can be affected by day. Night vision devices also need at least a small amount of light in order to work adequately.
- 7.8.6** The amount of darkness visual conditions at night is are affected by many factors, including the amount of moonlight, cloud and lighting made by human activity, such as structures and buildings. All authorities and units involved in SAR operations in which night vision devices are used should be aware of the effect that weather and light conditions can have on their performance. In very dark conditions, such as when there is no moon at all and significant clouds, night vision devices may be of little use during a SAR operation.

Effect of Artificial Lighting on Night Vision Devices

- 7.8.7** Night Vision systems can be adversely affected by powerful sources of artificial lighting, such as searchlights and pyrotechnic flares used by SRUs. These light sources should not be used without prior warning or agreement with SAR aircraft on scene.

Chapter 8 – (Amendment related to MRO)

[...]

8.1.1 SAR services may be required to perform operations other than search and rescue, which, if not carried out, could result in a SAR incident, such as:

- assisting a ship or aircraft which is in a serious situation and in danger of becoming a casualty, thereby endangering persons on board;
- broadcasting of maritime safety information (MSI);
- alerting appropriate authorities of unlawful acts being committed against an aircraft or ship; and
- assisting after the ship or aircraft has been abandoned, to minimize future hazards.

MSC.1/Circ.1183 contains guidance on the provision of external support as an aid to incident containment.

Chapter 9 – Conclusion of SAR operations

[...]

- Amend paragraph/section 9.6.1 as follows:

9.6.1 Constant improvement in the performance of the SAR system should be a clearly stated goal of SAR managers. One method to encourage performance improvement is to set up goals whose degree of attainment can be measured by key performance data. This data should be collected, analysed, and published on a routine basis so that individuals can see how the system as a whole is doing, and how their performance is contributing to the achievement of the established goals. ~~Where the SAR case load is high, some States have established computer databases to aid this analysis. Where the case load is lower, routine reports from the SMCs to the SCs or other SAR managers can be used for monitoring system performance and highlighting areas where improvement is possible through changes in policies, procedures, or resource allocation.~~

9.6.2 Performance management is the framework of processes and procedures used to ensure that an organization or unit can fulfil its objectives. Traditionally, organizational effectiveness was based on narrow performance measurement systems. Performance management should be considered as a holistic and continuous process which enlists the human dimension to set organizational direction, monitoring and measuring performance and taking corrective action as required.

9.6.3 The Balanced Scorecard approach to performance management assists managers to look at the business from different perspectives and take into account their linkages. The following four perspectives form the basis of a Balanced Scorecard approach of key indicators which identify which processes and activities are most important for fulfilling the organization's or unit's mission.

Manager and Staff Learning and Growth Perspective	
SAR Requirements	Measures
New entrants	Entry qualifications Theoretical and practical skills training, updating in SAR subjects
Professional Workforce	On the job training Formal Training Qualification & Certification Refresher training Exercises Case reviews Quality management basics
Engaged Workforce Participation	Engagement index Management and staff Performance Appraisal and Development system Internal Communications
Management	Manager competency framework

Priorities to support organizational change and innovation

Internal Business Processes Perspective	
SAR Requirements	Measures
SAR System	ICAO ANNEX 12
SAR Goals & Objectives	See para 5.2.3 IAMSAR Vol I
Enhanced management processes	Focus on quality assurance, see para 6.1.4 IAMSAR Vol I (i.e. per cent of processes that enable continuous improvement assessed i.e. a quality assurance system)
SAR Programme Statistics	Response times and appropriate response, See also para 5.6.2 IAMSAR Vol I, Data requirements*
Safety Oversight	Internal & External Audit Systems

Priorities for business processes

* Where the SAR case-load is high, some States have established computer databases to aid this analysis. Where the SAR caseload is lower, routine reports from the SMCs to the SCs or other SAR managers can be used for monitoring system performance and highlighting areas where improvement is possible through changes in policies, procedures, or resource allocation.

Customer Perspective	
SAR Requirements	Measures
Enhanced customer management processes	Customer engagement, forum for engaging with the end user or potential end user of the SAR services

Creating value for the customer

Stakeholder Perspective	
SAR Requirements	Measures
Enhanced management processes	Engagement and feedback with rescue units on incidents and exchange of information

Efficiency, effectiveness and value for money

In addition to the four perspectives outlined above, SAR managers should regularly review their performance management system and reviews should be inclusive of staff. SAR managers are also encouraged to develop and implement a training programme for all staff on performance management and quality assurance systems.

Correction and new paragraphs for section 9.7

9.7.2 The discussion on case review in paragraph 89.3.2 provides topics that typically may be examined during a case study.

9.7.3 To get a balanced view, SAR case studies should be done by more than one person; the case study team should include recognized experts in those aspects of the case being reviewed. To achieve maximum effectiveness, case studies should not assign blame, but rather should make constructive suggestions for change where analysis shows that such change will improve future performance.

9.7.4 When carrying out a case study, it is suggested that the following four components of crisis management are analysed:

- Report and alarm.
- Scale up and scale down.
- Leadership and coordination.
- Information management.

In carrying out a case study, guidelines for the evaluation should be drawn up beforehand. The guidelines should specify when to review a SAR incident, which areas should be paid attention to, what standards it should be measured against, who has to carry out the evaluation and what has to happen with conclusions or findings. An example of an evaluation format can be found in appendix H-9 "Guideline for Case Study Evaluation – Example of an Incident Evaluation Form".

9.7.5 In addition to SAR cases, accidents, exercises and drills should be carefully assessed and potential improvements to the SAR system identified. Lessons identified in such cases, and other information of use to the SAR community, should be shared as appropriate at local, national, regional and/or international level. States should consider whether to make formal reports to IMO and/or ICAO. The International Maritime Rescue Federation also provides an information-sharing platform: see Volume I Appendix D "Information sources". See also "Incident debriefings", below.

[...]

9.9.3 [...]

- (e) *SAR operation report.* This method of debriefing would be required after a significant SAR incident and/or when issues identified in the operation need to be addressed. The report would be prepared by the responsible authority in line with the process described in section 89.7. [...]

Appendix C

Mass rescue operations: exercises, industry roles and incident management

MRO exercises	[page no.]
MRO industry roles	[page no.]
MRO incident management	[page no.]
MRO communications in a maritime incident	[page no.]

MRO exercises

Since opportunities to handle actual incidents involving mass rescues are rare and challenging, exercising MRO plans are is particularly important. ~~Mass evacuation and rescue operations are difficult and costly, leading to a tendency to use simulation excessively during exercises rather than physically exercising on-scene efforts.~~ MRO exercises provide opportunities to improve MRO preparedness by:

- validating plans, policies, doctrine, procedures and the ability to conduct contingency operations;
- building, clarifying, and strengthening relationships with partners and stakeholders prior to an actual MRO incident;
- assessing preparedness/readiness with an emphasis on identifying shortfalls and closing gaps;
- refining plans, identifying available resources and capabilities, conducting training, and evaluating training plans; and
- providing familiarization and on-the-job training for players in their roles and responsibilities for conducting contingency operations.

~~Full-scale live MRO exercises are difficult and costly to arrange, requiring hundreds of people to be rescued and multiple SAR facilities. MRO exercise objectives need not be addressed in a single large exercise, but may be satisfied in part by routine incorporation into multiple drills, tabletop exercises, command post exercises, etc. some intended mainly to test other systems. However, realistic drills are still necessary and costly, and over 1,000 volunteer ship passengers or hundreds of volunteer aircraft passengers will likely be needed to conduct a realistic exercise. Separate rooms can be used to simulate command posts that would normally be in separate locations.~~

MRO exercises should ideally achieve the following objectives:

- test:
 - RCC procedures and processes,
 - SAR coordination and communications procedures,
 - communications planning and management,
 - information coordination and management,
 - search planning and search area coverage, and

- use of systems, equipment and SAR techniques;
- account for:
 - ~~crew and passenger lists~~ all involved in the operation,
 - rescued passengers and crew until they can return to their homes,
 - all persons associated with the rescue and aftermath operations, and
 - ~~lifeboats~~ survival craft, including empty boats or rafts; and
 - ~~exercises should take account of high freeboard issues for likely rescue facilities;~~
- identify and task available resources:
 - use of Amver or other ship reporting systems,
 - other potential resources ashore and afloat, including military and other government resources,
 - resources from local agencies (medical personnel, hospital facilities, fire department, general community, transportation resources, etc.),
 - on-board support resources, and
 - national and regional ~~military and other~~ resources;
- evaluate notification processes, resource availability, timeliness of initial response, real-time elements, conference capabilities and overall coordination;
- ensure all agency roles are specified, understood and properly followed;
- test capabilities of potential OSCs and ability to transfer OSC duties;
- test capabilities of potential ACOs and ability to transfer ACO duties;
- ~~evaluate span of control;~~
- evacuate a ship or aircraft;
- coordinate search and rescue activities and achieve information exchanges:
 - communications (RCC/RCC, Government/industry, RCC/OSC/ACO, on-scene, shore/ ship, ground/air, ship/air, SAR facility/survival craft, etc.),
 - information for all concerned (identify, merge, purge, retrieve and transfer to the right place in the right form at the right time),
 - new communication and information management technologies, and
 - media and next of kin;

- test all communication links that may be needed for notification, coordination and support;
- test capabilities and techniques for retrieving people into SAR facilities, taking into account high freeboard issues etc.;
- safely transfer and care for passengers survivors (evacuation, in survival craft, rescue, medical, protection from environment, post-rescue transfers, etc.);
- provide food, water, lifejackets and other protective clothing to survivors;
- conduct medical triage and provide first aid;
- identify place(s) of safety and test landing and transfer procedures;
- ~~— assess ship's safety management system effectiveness;~~
- exercise coordination with local response between all responding agencies;
- test mass rescue plans of:
 - SAR services,
 - operating company (including aircraft and ship plans airline, ship operator, etc.),
 - any other relevant emergency response organizations, e.g. disaster response, military, fire-fighting and medical, and
 - transportation and accommodation companies;
- assess how effectively earlier lessons learned previously identified have been accounted for in updated plans and how well these lessons were disseminated shared;
- exercise salvage and pollution abatement capabilities;
- carry out emergency relocation of the disabled craft; and
- exercise external affairs, such as international and public relations taking into account:
 - necessary participants involved,
 - joint information centres established quickly and properly staffed,
 - press briefings handled effectively, e.g. consistent information from different sources,
 - notification of the next of kin and family briefings,
 - staff and equipment capacity to handle incoming requests for information, and

- rescued persons tracked, kept informed, and needs monitored, and reunited with belongings.

The following steps are normally carried out during exercise planning:

- agree on the exercise scenario, goals and extent;
- assemble a multi-disciplinary planning team and agree on objectives for each aspect of the exercise;
- develop the main events and associated timetables;
- confirm availability of agencies to be involved, including any media representatives or volunteers;
- confirm availability of transportation, buildings, equipment, aircraft, ships or other needed resources;
- test all communications that will be used, including tests of radio and mobile phones at or near the locations where they will be used;
- identify and brief all participants and people who will facilitate the exercise, and ensure that facilitators have good independent communications with person who will be controlling the exercise;
- ensure that everyone involved knows what to do if an actual emergency should arise during the exercise;
- if observers are invited, arrange for their safety and keep them informed about the exercise progress;
- for longer exercises, arrange for food and toilet facilities;
- use "exercise in progress", signs, advance notifications and other means to help ensure that persons not involved in the exercise do not become alarmed;
- schedule times and places for debriefs;
- agree and prepare conclusions and recommendations with the entity responsible for handling each recommendation along with the due date for any actions;
- prepare a clear and concise report and distribute it as appropriate to the participating organizations and more widely, as agreed; and
- consider the outcome of this exercise in planning future exercises and operations.

MRO industry roles

[As only two minor changes are proposed for this section, only the two paragraphs concerned are included here.]

SAR authorities should coordinate MRO plans with companies that operate aircraft and ships designed to carry large numbers of persons. Such companies should share in preparations to minimize the chances that MROs will be needed, and to ensure success if they are. This section provides guidance on industry roles, and discusses how companies could arrange for use of company field teams and emergency response centres as possible means of carrying out their MRO responsibilities.

[...]

There are other steps the transportation industry could be urged to undertake to improve preparedness for MROs. The following are some examples:

- carry SAR plans on board aircraft or ships;
- provide water and thermal protection for evacuees appropriate for the operating area;
- provide a means of rescue to bring people from the water to the deck of ships: a means of rescue is a requirement for ro-ro passenger ships, and ships on international voyages are required to have ship-specific plans and procedures for recovery of persons from the water;
- use preparation checklists provided by SAR authorities;
- conduct an actual physical exercise in addition to simulations;
- provide the capability to retrieve fully loaded lifeboats and rafts;
- enhance lifeboat lifesaving capabilities;
- provide ways to assist persons in lifeboats survival craft who are seasick, injured or weak;
- provide on board helicopter landing or winching areas;
- prepare to assist survivors until and after they have been delivered to a place of safety;
- have aircraft or ship status and specifications readily available, such as inspection records, design plans, communication capabilities, stability calculations, lifesaving appliances, classification society contacts, passenger and cargo manifests, etc., so that such information will not need to be obtained directly from a pilot or master; and
- work with SAR authorities to develop and be able to rapidly deploy air droppable equipment or supplies for survivors, maintain strategically located caches for this purpose.

[...]

MRO incident management

For major incidents, crisis management for the overall response may ~~may~~ will also be needed. The **Incident Command System (ICS)**, one widely used means of meeting this need, works best with some advance familiarization and exercising within and among the transportation and emergency response communities. Since SAR and transportation authorities are likely to encounter use of the ICS within emergency response communities, this appendix provides general information for familiarization with ICS.

[As no further changes are proposed for the remainder of this section, it is omitted here.]

MRO communications in a maritime incident

Efficient communications in major maritime response incidents are best arranged by dividing communications between several different frequencies. The number of frequencies used may vary, depending on the circumstances, but is unlikely to exceed five. The diagram below shows a major incident with numerous surface and air units responding and several different activities taking place on scene and, in support, ashore. The communications plan set up to deal with this incident is relatively simple so that all those responding may readily understand it. It needs to be established from the outset.

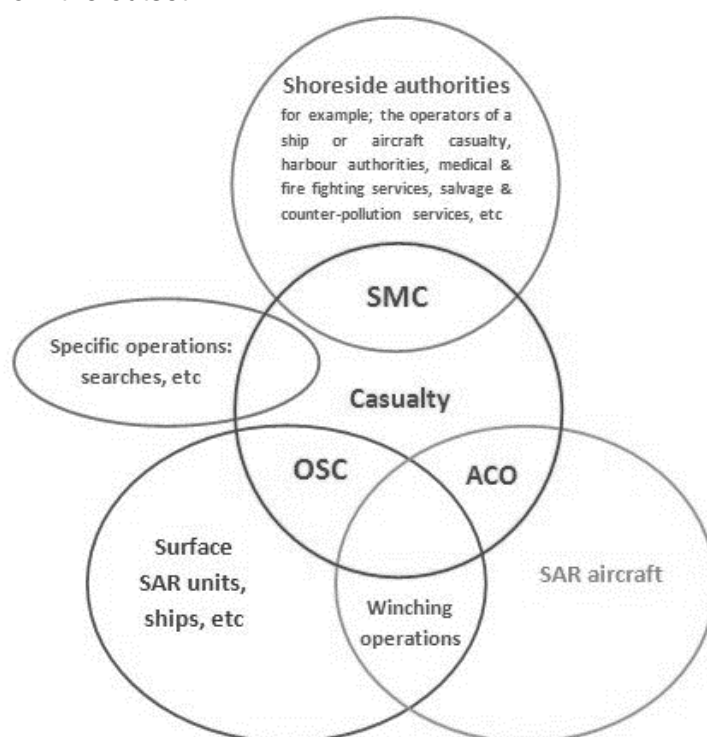

Figure C-2 – *Concept of a communications plan for a major incident*

- 1 The primary coordinating frequency – initially VHF FM channel 16 but a common working frequency may be assigned to ensure channel 16 is available for other distress alerts – is used by the casualty, the OSC, the ACO (if designated) and, if possible, the SMC. If the incident is out of the SMC's VHF range, the SMC will communicate primarily with the OSC by satellite or MF or HF radio communications. Other units on scene should monitor the primary coordinating frequency if possible, to be kept up to date by SITREPs, etc., but will not usually transmit on it.
- 2 Surface SAR units and other surface units such as ships responding to the distress alert will use a second frequency – usually VHF FM channel 6 – controlled by the OSC.
- 3 Aircraft may also use this second frequency under the OSC's control, if suitably equipped. An ACO should be designated if responding aircraft are not equipped with marine VHF or in cases where it would be more efficient to control them separately (such as multiple aircraft on scene). The aircraft will then use a third frequency – usually VHF AM 123.1MHz – controlled by the ACO. For further information on communications in multiple-aircraft cases, see chapter 7, "Multiple Aircraft SAR Operations", and appendix T.

- 4** If other activities are taking place on scene, additional frequencies may be used for the necessary communications. If a helicopter, for example, needs to winch to or from a ship, these two units should switch to a mutually compatible frequency not already in use, returning to the main working frequencies after the winching operation is complete. Another example would be a search being conducted as part of the overall SAR operation. In this case, the units assigned to the search will switch to a mutually compatible frequency controlled by a search coordinator. This coordinating unit reports to OSC or RCC, as appropriate.
- 5** In a major incident, such as an MRO, there will need to be significant exchange of information with authorities ashore: the operators of a ship or aircraft casualty, harbour and other receiving authorities, shoreside emergency services providing support, authorities and agencies concerned with counter-pollution and salvage operations, and so on. These many organizations should communicate via the RCC, not directly with units on scene. This enables the SMC to maintain a clear overall picture of the response. Efficient procedures for this aspect of the communications plan can and should be pre-planned. The exchange of liaison officers is recommended.

Appendix D

Uncertainty phase data (new text on page D-8)

Communication searches

Communication search for marine craft

[...]

3 If the missing craft is known to have a radio aboard, SAR units RCCs should arrange for contact to be attempted. ~~should attempt contact.~~ If a mobile device is known to be carried, attempt contact. ~~Marine operators~~ Vessels, Ports, harbours, VTS, etc. in the areas of interest should be asked to check their logs for traffic to or from the craft and attempt to contact the craft regularly. Coast Radio Stations ~~Public correspondence marine operators (MAROP)~~ should be asked to attempt ~~at least one~~ contact.

4 If persons are known or believed to have mobile devices, attempt to obtain information about these, and attempt contact. If anyone on board has a tracking and locating app, attempt to obtain information from the app, e.g. track history, current or last known position.

5 The actual departure location and time should be confirmed. The craft's non-arrival should also be confirmed and a request made that the RCC be notified immediately if it does arrive.

56 Each facility need to be contacted only once during the search

[...]

Communication search for aircraft

[...]

4 Contact ATS units, ~~a~~Alert airfields, refuelling points, ~~aeronautical radio stations, aeronautical aids to navigation stations,~~ and radar and DF stations within areas through which the aircraft may have flown.

5 If persons on board aircraft are known or believed to have mobile devices, attempt to obtain information about these, and attempt contact. If anyone on board has a tracking and locating app, attempt to obtain information from the app (e.g. track history, current or last known position,...).

[...]

MEDICO or MEDEVAC checklist

[...]

Insert new text after 12 *Other pertinent information*

When medical advice by a TMAS or a similar medical consultation service is not available to the RCC/SMC, then the following medical consultation questions may be appropriate for the RCC/SMC to consider asking a doctor based on the information provided from the vessel:

1 *What is the most likely diagnosis based on the symptoms and signs?*

The doctor is making a preliminary diagnosis on information which could be incomplete and may be inaccurate. However, this is the best information available and leads to the next questions.

2 *What do they need, taking into account the medical competencies, equipment and medications on board the vessel?*

3

What medical care, intervention or procedure does the patient require to address the medical condition? This may include a specific doctor's prescription for care on scene and en route to a medical facility.

4 *Where can they get the required medical attention?*

Which medical facilities have the required capability to meet the needs of the patient? If there are no specific or specialized medical requirements, then delivery is to the nearest hospital. This recommendation must also consider the responding craft (e.g. weather, fuel, endurance/range, etc.).

5 *How soon do they need treatment?*

There may be a need for an immediate launch of a helicopter or vessel; or, a need to advise the vessel to divert towards a port with the appropriate medical facilities; or, maybe the MEDEVAC should wait for better weather, daylight hours, etc.

Based on the replies to the questions above, the doctor could then make one of three recommendations to the RCC/SMC:

1 MEDEVAC recommended:

a. with medical personnel/paramedics, as appropriate; or

b. medical personnel/paramedics delivered to vessel (patient evacuation to be decided by medical personnel/paramedics); or

c. by providing advice to the ship to divert towards a port with appropriate medical facilities;

2 MEDEVAC not recommended – not deemed medically necessary (person can be treated on board or can await vessel's arrival in port).

- 3 MEDEVAC not recommended at the time because it is assessed that transport would increase the risk to the patient. If possible, medical personnel/paramedic should be delivered to the vessel to provide further medical assistance.

Lost person checklist

[...]

Insert new text after 15 *Other pertinent information*

If a missing person is known or believed to have mobile devices, attempt to obtain information about these and attempt contact. If the person has a tracking and locating app, attempt to obtain information from the app (e.g. track history, current or last known position).

Appendix F

Distress phase checklist
[...]

- 17 Consider tracking and locating capabilities of mobile telecommunication devices, e.g. mobile phones and apps.

Renumber the following paragraph accordingly

Appendix G

Facilities and equipment selection

G.3.2 Knowing the positions of merchant ships is often of considerable value in SAR operations. They are frequently the closest available means of search or rescue in a SAR incident on or over the high seas. It is very important that RCCs fully use ~~Inmarsat~~ appropriate voice/data satellite communications services, GMDSS, CRS, VTS and other means of communication described in chapter 2 of this volume

[...]

G.7 Supply colour coding and pictograms

G.7.1 Containers or packages containing survival equipment for dropping to survivors should have the general nature of their contents indicated by a colour code, printed indication (in English and ~~two or more other~~ additional languages adapted to the intended area of operation), and self-explanatory symbols.

~~**G.7.2** The colour identification of the contents of droppable containers and packages of survival equipment should have streamers coloured according to the following code:~~

~~RED: Medical supplies and first-aid equipment.~~

~~BLUE: Food and water.~~

~~YELLOW: Blankets and protective clothing.~~

~~BLACK: Miscellaneous equipment such as stoves, axes, compasses, and cooking utensils.~~

G.7.3 2 Bands of suitable pictograms in retro-reflective material should also be used. Pictograms are shown in figure G-1.

Appendix H

Operation briefing and tasking forms

SAR operation report, page H-8

- Amend SAR operation report, Part II, 2. d. to remove "target" and replace with "search object":...distance from the ~~target~~ search object, ...
- Add new form as follows:

Page H-i, new last entry: **Guideline for Case Study Evaluation.....H-10**

add new form: **Guideline for Case Study Evaluation**

An example of an incident evaluation form

Incident

Details of Incident

- Incident Number
 - DTG
 - Type
 - Position (lat/long)
 - Weather Conditions
 - Wind direction/force
 - Cloud
 - Visibility
 - Current direction/speed
 - Watch Division(s) (split into Divisions respectively)
 - Units
 - Maritime
 - Aircraft
 - Emergency services land
 - Any other relevant information (include as an attachment but list here)
 - Scan of nautical chart showing positioning of incident in relation to land/familiar point of reference, to help build up a clear picture
 - Photographs
- Note: All times in UTC

Description of Incident

Stick to facts, no value judgements...

Reason for evaluation

Brief explanation of reasons why this incident is subject to evaluation (see results of quick scan).

Report and Alarm

Explanation

The first step in activating an incident response organization is to acknowledge a reported incident and alert the emergency services. A report has to be converted rapidly into an effective alert if emergency assistance is to arrive quickly. To do that, a fixed structure must be observed for processing reports and alerting units.

RCC Response, Response Time and Communications

1.1.1. Standard

The RCC receives a report. The contents of the report must be clarified quickly (three minutes). In order to make a report complete as quickly as possible, questions must be asked briefly and to-the-point, professionally and assertively. The information ascertained is then used to create an alert and, as a part thereof, an initial deployment. To check this, listen to the recorded audio material from the incident.

1.1.2. Assessment

1.1.3. Sub-Conclusion

1.1.4. Recommendation(s)

Incident Records

1.1.5. Standard

Records of the incident need to be kept as stipulated. The information included also needs to be complete. A layperson should be able to follow and understand the incident on the basis of the records kept. Essential information is marked.

1.1.6. Assessment

1.1.7. Sub-Conclusion

1.1.8. Recommendation(s)

Scale up/Scale down

Explanation

An incident response organization can scale up or scale down depending on several factors, which are:

- The severity of the incident.
- The extent of the incident.
- The location of the incident.
- The seriousness of the situation for external organizations.

Ultimately, in the event of scaling up it must be ensured that a suitable number and suitable standard of people and resources are deployed.

Estimation of severity of incident

1.1.9. Standard

The information available must be fully used and interpreted at all times. A picture of the incident should be built up as soon as possible and a worst case scenario should be assumed. If the severity was underestimated, how did this happen?

1.1.10. Assessment

1.1.11. **Sub-Conclusion**

1.1.12. **Recommendation(s)** Leadership and Coordination

Explanation

Some of the aspects relating to leadership and coordination include: setting priorities in mutual consultation in dealing with the incident (the decision-making process), but also coordinating and leading the actual response workers or the response procedures themselves. The results of this should be monitored in order that assessment and adjustment be possible.

Leadership

1.1.13. **Standard**

The watch manager should lead his team. As events occur, he/she should clearly take the lead. People work together as a team and share information with each other directly. All this is in line with the training.

1.1.14. **Assessment**

1.1.15. **Sub-Conclusion**

1.1.16. **Recommendation(s)**

Coordination by the RCC

1.1.17. **Standard**

The RCC should provide strong leadership for the deployed emergency services and ensure there is coordination between the parties. The RCC therefore needs to have an accurate picture of the situation at all times. Also ask the deployed emergency services how they experienced the RCC's role.

1.1.18. **Assessment**

1.1.19. **Sub-Conclusion**

1.1.20. **Recommendation(s)**

Information management

Explanation

Information management is both a technical and organizational process. The more quickly and more comprehensively information becomes available, structured incident response options increase accordingly.

Sharing Information

1.1.21. **Standard**

Information needs to be available in the right format and at the right time for the people who need it. They include the deployed units and the RCC itself.

1.1.22. **Assessment**

1.1.23. Sub-Conclusion

1.1.24. Recommendation(s)

Use of IT resources

1.1.25. Standard

The watchstanders need to be sufficiently trained and experienced in using various IT resources and applications. Were all of the available IT resources suitable for this incident used correctly and smoothly? All this is in line with training.

1.1.26. Assessment

1.1.27. Sub-Conclusion

1.1.28. Recommendation(s)

Use of means of communication

1.1.29. Standard

Technical: The watchstanders need to be sufficiently trained and experienced in using various means of communication. Are they using the correct frequencies, are they making the correct connections? Are the available means of communication being used in the correct way? All this is in line with what was learnt in training for this role.

Skills: There should be effective outward communication with the emergency services, other parties and other individuals. This includes when asking for further information but also cutting conversations short when necessary.

1.1.30. Assessment

1.1.31. Sub-Conclusion

1.1.32. Recommendation(s)

Use of procedures (applicable to this incident)

1.1.33. Standard

Incident responses often automatically take the form of established procedures and action plans. These must be adhered to. If the applicable procedures and/or action plans are not carried out, or are carried out differently, this should be accounted for and justified, including in the incident records. Are the procedures up to date?

1.1.34. Assessment

1.1.35. Sub-Conclusion

1.1.36. Recommendation(s)

Reconstruction (optional)

Introduction

In some cases it may be useful to reconstruct the incident in the form of a training session with another team. This makes it possible to assess whether another team would have handled the incident differently and/or would have arrived at a different outcome. This gives a clearer perspective on the incident response in question.

Findings

Conclusion on the reconstruction

Overall conclusion

RCC's role and outcomes for this incident

Here, try to give an idea of what would have happened if the RCC had not responded to the incident, i.e. the worst-case scenario.

Sub-Conclusions and Recommendations

Overall conclusion

Attachments (including notes from meetings, photographs, etc.)

Each evaluation should include a scan of a nautical chart showing the positioning of the incident in relation to land/familiar point of reference, to help build up a clear picture.

Appendix K

Determining datum

- Add new form as follows:

Page K-i, new last entry: Determining datum, estimating range and bearing of pyrotechnic distress signals.....K-35

- Add new form as follows:

Determining Datum, Estimating Range and Bearing of Pyrotechnic Distress Signals

K34.1 Types of Flares and their Characteristics

.1 There are generally three types of flares available and used for distress signalling:

- parachute flare: widely available parachute distress flares are used by commercial ships, fishing vessels and small craft mariners;
- meteor flare: rocket type (i.e. non-parachute) flare; and
- hand-held flare: standard international distress flare used by commercial and recreational users.

.2 Flare Characteristics

Type	Trajectory	Average Ht	Candlepower Nominal Range	Peak Duration (min)	Burn
Parachute	Rapid Rise Slow Descent	1000-1200 ft	20,000-40,000 14-20 NM	30-40 Secs	
Meteor	Rapid Rise Rapid Descent	250-400 ft	10,000-30,000 15-17 NM	5 Secs	
Hand-held	Steady	Assume 10 ft	500-15,000	50-120 Secs	

.3 Notes:

- .1 The angle of observation of a flare sighting is measured from the horizon to the top of the flare trajectory (if seen).
- .2 Parachute flares will only be seen as they descend – they begin burning when they reach the top of their trajectory.
- .3 Meteor flares may be seen over the whole of their trajectory – they burn from the moment they are fired.

K34.2 Assessing Direction of Flare

.1 There are several options to obtain the direction or bearing of the flare:

- clock face method;
- bearing from a compass;
- reference to a physical object (building, island, anchored ship, navigation buoy, etc.);
- experience (seafarers can often give accurate bearings in relation to their ships heading, etc.).

.2 Clock Face Method

- For members of the lay public, it may be best to ask them to use the clock face method. If they are on a beach or shoreline ask them to turn to their left or right and look along the shoreline and to imagine a clock is laid on the ground with 12 o'clock at the top (aligned along the beach/surf line). They should then be asked to report what "time" the flare was e.g. 9, 10, 11, 12, 1, 2, 3, 4, 5 o'clock, etc.

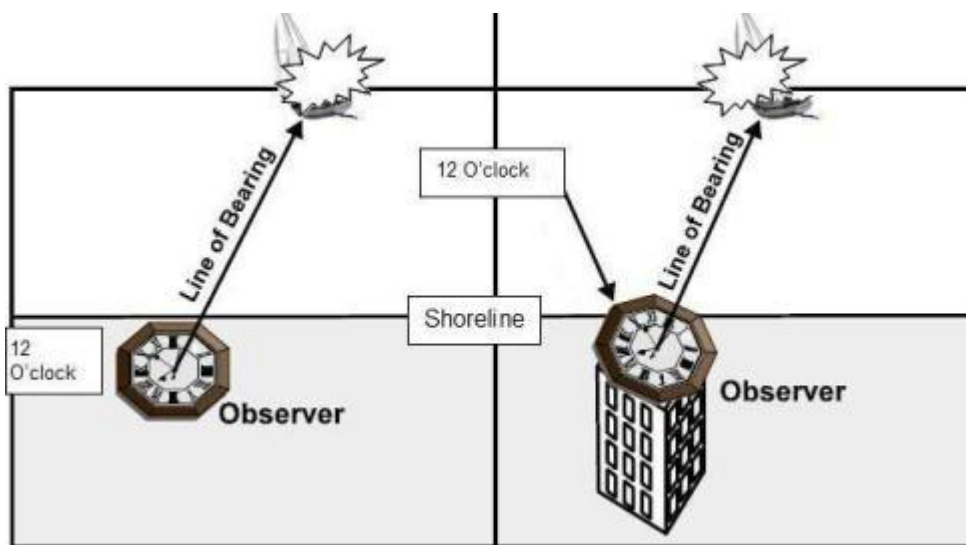

Image courtesy of USCG

.3 In the above drawings, the first flare would be reported as bearing about 4 o'clock.

.4 The second might be reported as 3 o'clock from the North side of the building, or the side of a building on a particular street, etc.

.5 Other options for establishing direction of a flare are:

- direction relative to a street direction;
- direction relative to a line passing through reporting source's position and another prominent landmark or reference point;

- identity of prominent landmarks on either side of the line of bearing from the reporting source to the flare; and
- direction relative to the general direction of the shoreline in that area.

.6 An appropriate amount of bearing error will have to be added to any such reports to ensure that the likely direction of the flare is captured.

K34.3 Flare Source v Horizon

.1 Flare sighted – source beyond (over) the visible horizon

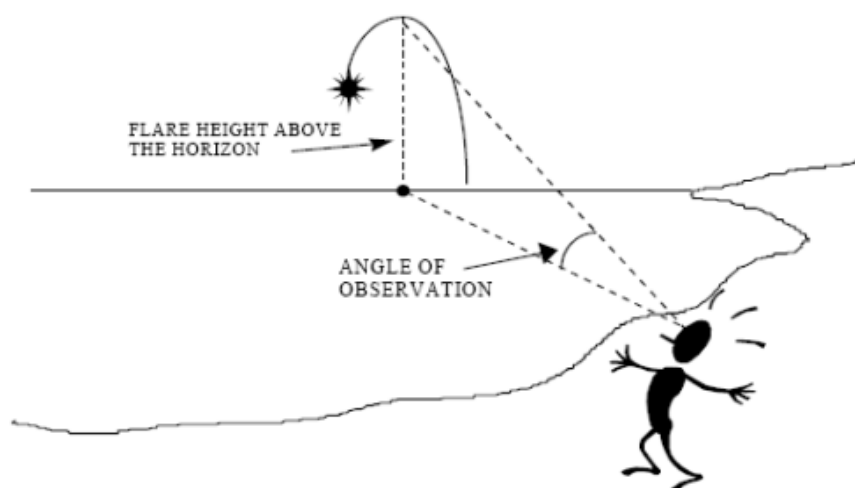

Image courtesy of USCG

.2 Flares may have been fired from beyond (over) the horizon or the informant may only be seeing part of its trajectory. This can be dealt with by adding an appropriate amount of maximum range error to the reported angle

K34.4 Flare sighted – source below (within) the visible horizon

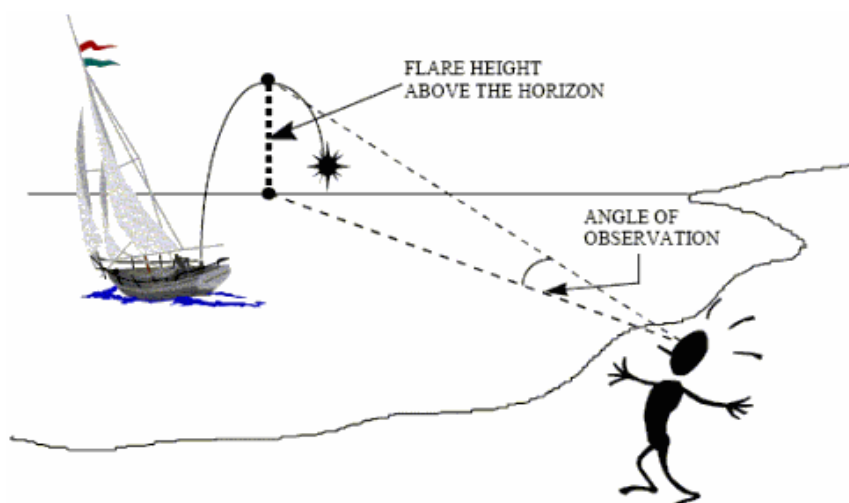

Image courtesy of USCG

- .1 Flare may also be seen to rise above the horizon but the source may be below and within the observer's horizon.
- .2 Remember that if a flare is seen by an observer at (or around) sea level (height of eye up to 10 feet) and it is seen to rise at an angle greater than 8 degrees, then the source must be within 1.4 NM of the observer.

K34.5 Assessing the Range

- .1 Geographic Range – Height of Eye only

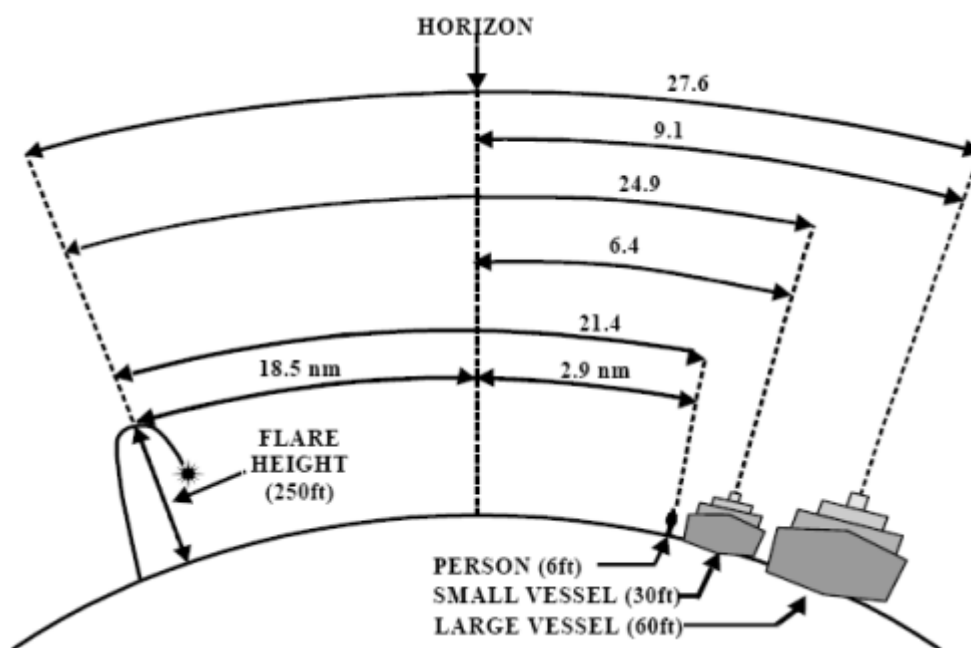

Image courtesy of USCG

- .2 The above image illustrates the maximum distance at which the curvature of the earth permits a light to be seen from a particular height of eye without regard to the luminous intensity of the light. Geographic range can be determined by adding the distance of the horizon from the observer and the distance of the horizon from the light.

K34.6 Estimating Flare Distances

- .1 Informants should be asked to use the "clenched or closed hand" method to estimate the angle above (or below) the horizon that they saw the flare
- .2 The informant should be asked to hold their clenched/closed-hand vertically, with thumb on top, at arms-length, and place the bottom of the hand on the visible horizon and then to estimate how many fingers above the horizon the flare was. Reports of less than a finger width are viable and should be recorded.

K34.7 Flares observed above the Horizon

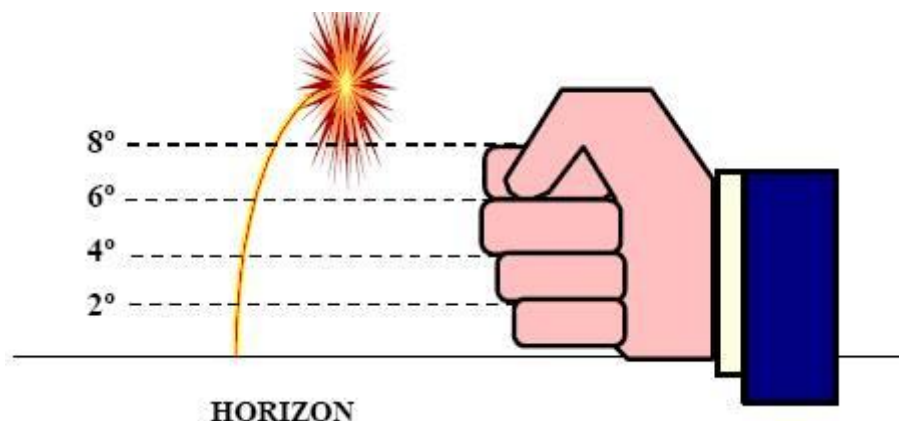

Image courtesy of USCG

(In this example the flare would be reported as about 9 degrees above the horizon.)

.1 The (Above Horizon) distance tables in Appendix N22 are then used to estimate the minimum and maximum distances to the flare from the reporting source. Angles are determined by converting fractions of a fist to degrees.

.2 Example:

A red flare is reported using the Fist method as being 2 fingers above the horizon. The first informant's height of eye is 10 feet.

Converting the fingers to degrees gives an estimated angle of observation of degrees.

- *Referring to the Minimum Distance table suggests a distance of 0.57 nm*
- *Referring to the Maximum Distance table suggests a distance of 2.82 nm*

Given this range of observed angles, the flare must be roughly between 0.6 and 2.8 nm from the reporting source – a separation of only 2.2 nm. A more expedient estimate is obtained by "rounding" the minimum distance down and the maximum distance up to the next 0.5 nm increment.

In this example we would therefore use a range of between 0.5 to 3.0 nm from the reporting source.

K34.8 Flares observed below the Horizon

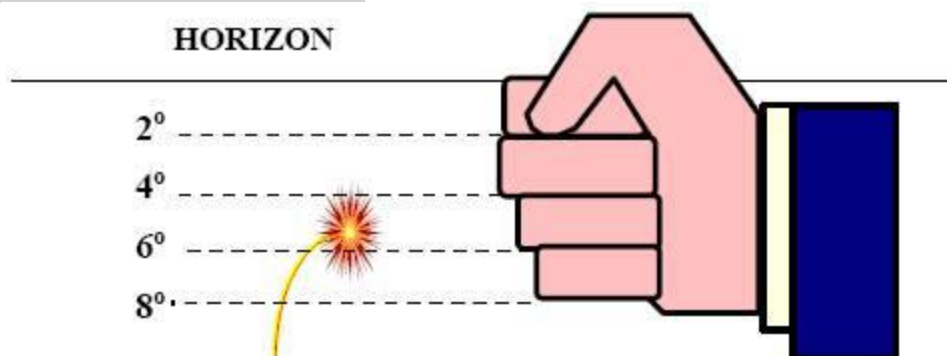

Image courtesy of USCG

(In this example the flare would be reported as about 5 or 6 degrees below the horizon)

- .1 As with the "above horizon" observation, the "closed hand" estimate is converted to degrees and the Minimum and Maximum (Below Horizon) Range tables used to determine the minimum and maximum distances of the flare from the observer.

K34.9 Flare Distance Tables (Appendix N22)

- .1 The flare distance data is taken from the USCG Addendum to the US National SAR Supplement to IAMSAR – used with permission of the USCG.

K34.10 SEARCH PLANNING FLARE SIGHTINGS

.1 Manual Method

- i) obtain the estimated bearing and vertical angle of the flare from the informant;
- ii) look up the likely minimum and maximum ranges in the tables – applying an appropriate amount of error e.g. +/- half a NM (use Maximum & Minimum Range Tables);
- iii) plot the informant's position on a chart or map;

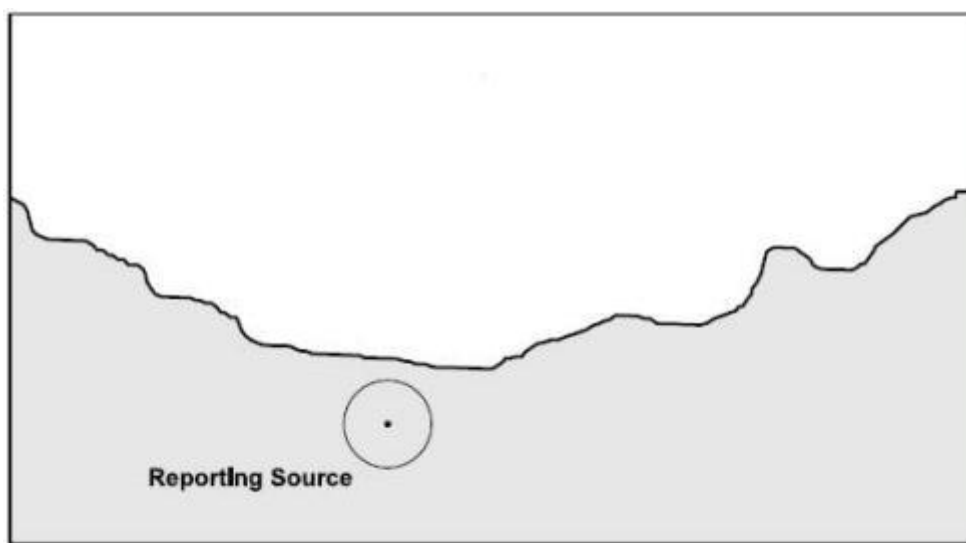

Image courtesy of USCG

- iv) draw an error circle around the informant's position according to how accurate their position report is. If in doubt, apply at least a 0.25 NM (or more) radius error;
- v) draw a line of bearing along the direction the informant reported and apply a bearing error according to the accuracy of the report. If in doubt apply at least 20 degrees either side of the bearing line;

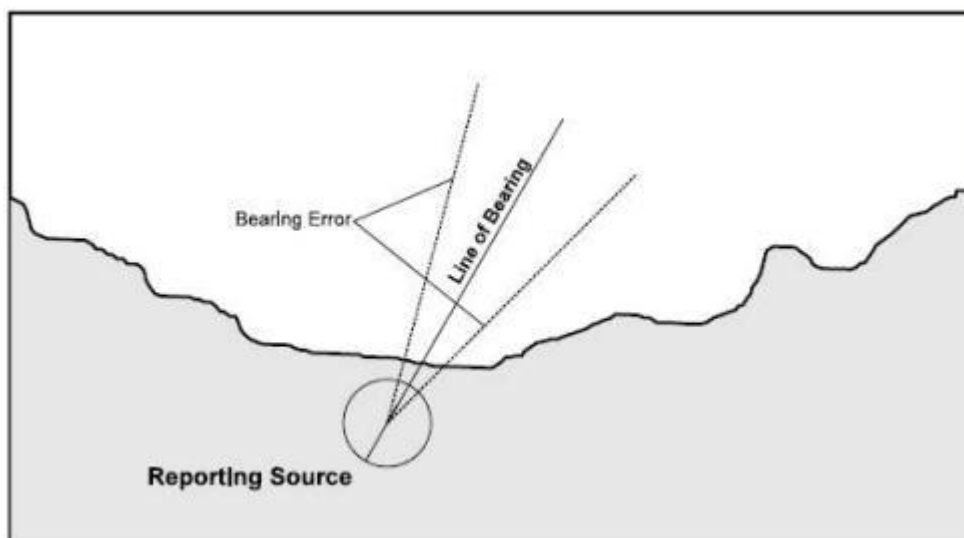

Image courtesy of USCG

- vi) draw two more bearing error lines from the edges of the informant's position error circle, parallel to the first bearing error lines;

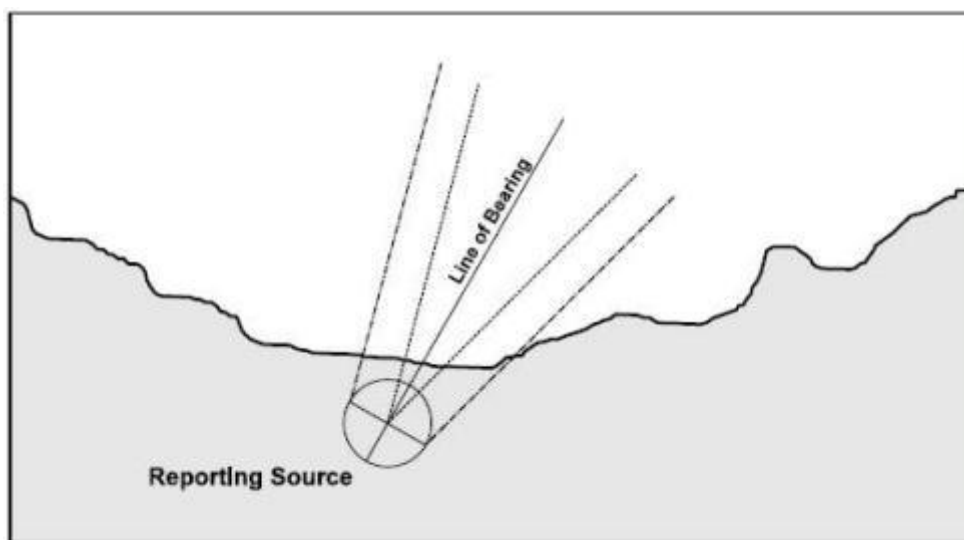

Image courtesy of USCG

- vii) calculate the maximum and minimum ranges of the flare (using the tables) and plot these as arcs from the informant's position onto the search plan;

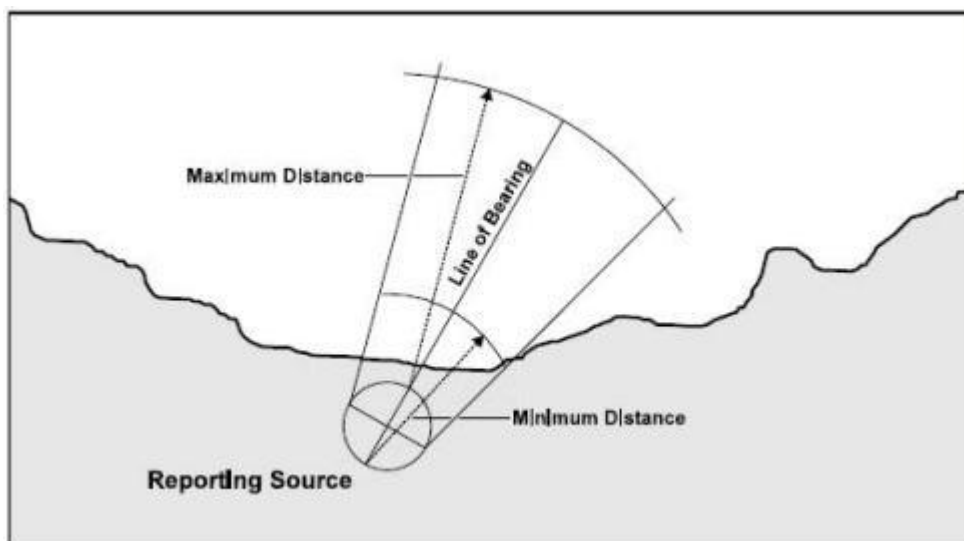

Image courtesy of USCG

- viii) draw a search box around the area – making sure that the box fully encompasses the widest bearing errors and maximum and minimum range arcs; and

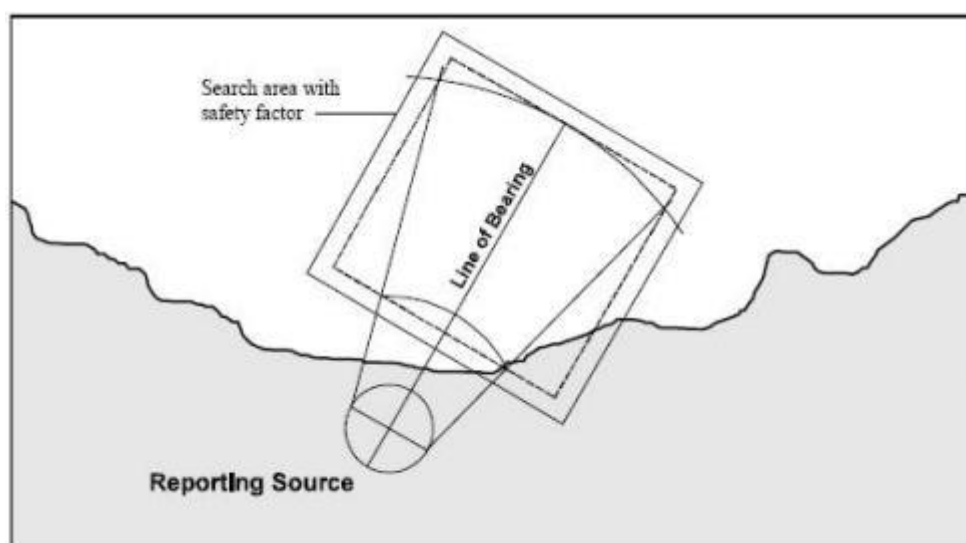

Image courtesy of USCG

- ix) the search area should be drifted with tide and leeway as required. If elapsed time between report and launch of an SRU or response of a nearby vessel is short, then this may not be immediately necessary.

.2 The above area can also be loaded into a search planning computer and drifted as an Area so that accurate tide and wind vectors can be calculated.

K34.11 Multiple Flare Sighting Reports

- .1 If multiple reports are received about the same flare, the same technique should be used but each informant's position should be plotted separately and merged into one, larger search area:

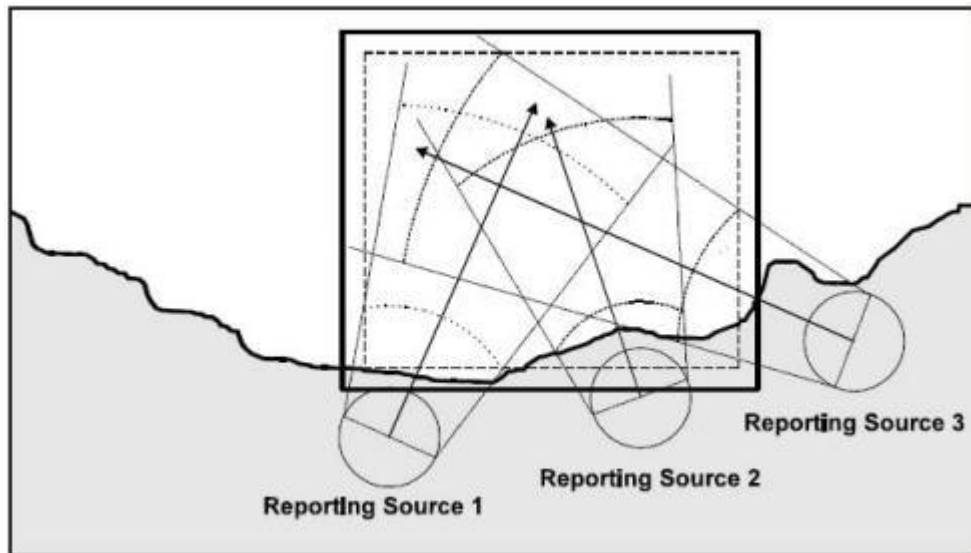

Appendix N

Tables and graphs

Add new section on page N-22 as follows:

- Page N-i: Pyrotechnic Distress Signals Minimum and Maximum Range Tables (tables N-22 to N- ...N-22)

**Pyrotechnic Distress Signals Minimum and Maximum Range Tables
(US Coast Guard Flare Range Tables)**

N22.1 The following tables are used to accurately calculate the location area of a pyrotechnic distress signal.

N22.2 Parachute Flare above the Horizon – Minimum Distance

Angle of Observation above the Horizon – Minimum Distance to the Flare (NM)

Reporting Source Height ft	0.5°	1.0°	1.5°	2.0°	2.5°	3.0°	3.5°	4.0°	5.0°	6.0°	7.0°	8.0°	10.0°	12.0°	14.0°	16.0°
10	4.68	2.35	1.55	1.16	0.92	0.77	0.65	0.57	0.46	0.38	0.32	0.28	0.23	0.19	0.16	0.14
20	4.71	2.31	1.51	1.12	0.89	0.74	0.63	0.55	0.44	0.36	0.31	0.27	0.22	0.18	0.15	0.13
30	4.69	2.25	1.46	1.08	0.86	0.71	0.61	0.53	0.42	0.35	0.30	0.26	0.21	0.17	0.15	0.13
40	4.64	2.18	1.41	1.04	0.83	0.68	0.58	0.51	0.40	0.33	0.29	0.25	0.20	0.16	0.14	0.12
50	4.57	2.11	1.36	1.00	0.79	0.65	0.56	0.49	0.39	0.32	0.27	0.24	0.19	0.16	0.13	0.12
60	4.47	2.03	1.30	0.96	0.76	0.62	0.53	0.46	0.37	0.30	0.26	0.23	0.18	0.15	0.13	0.11
70	4.37	1.95	1.24	0.91	0.72	0.59	0.50	0.44	0.35	0.29	0.25	0.21	0.17	0.14	0.12	0.10
80	4.25	1.87	1.19	0.87	0.68	0.56	0.48	0.42	0.33	0.27	0.23	0.20	0.16	0.13	0.11	0.10
90	4.12	1.78	1.12	0.82	0.64	0.53	0.45	0.39	0.31	0.26	0.22	0.19	0.15	0.13	0.11	0.09
100	3.97	1.69	1.06	0.77	0.61	0.50	0.42	0.37	0.29	0.24	0.21	0.18	0.14	0.12	0.10	0.09
110	3.81	1.59	1.00	0.72	0.57	0.47	0.40	0.35	0.27	0.23	0.19	0.17	0.13	0.11	0.09	0.08
120	3.64	1.50	0.93	0.68	0.53	0.44	0.37	0.32	0.25	0.21	0.18	0.16	0.12	0.10	0.09	0.08
130	3.46	1.40	0.87	0.63	0.49	0.40	0.34	0.30	0.24	0.19	0.17	0.14	0.11	0.09	0.08	0.07
140	3.26	1.29	0.80	0.58	0.45	0.37	0.31	0.27	0.22	0.18	0.15	0.13	0.10	0.09	0.07	0.06
150	3.05	1.19	0.73	0.53	0.41	0.34	0.29	0.25	0.20	0.16	0.14	0.12	0.10	0.08	0.07	0.06
160	2.83	1.08	0.66	0.48	0.37	0.30	0.26	0.22	0.18	0.15	0.12	0.11	0.09	0.07	0.06	0.05
170	2.59	0.97	0.59	0.43	0.33	0.27	0.23	0.20	0.16	0.13	0.11	0.10	0.08	0.06	0.05	0.05
180	2.34	0.86	0.52	0.37	0.29	0.24	0.20	0.18	0.14	0.11	0.10	0.08	0.07	0.06	0.05	0.04
190	2.07	0.74	0.45	0.32	0.25	0.20	0.17	0.15	0.12	0.10	0.08	0.07	0.06	0.05	0.04	0.03
200	1.78	0.62	0.38	0.27	0.21	0.17	0.14	0.13	0.10	0.08	0.07	0.06	0.05	0.04	0.03	0.03
220	1.15	0.38	0.23	0.16	0.13	0.10	0.09	0.08	0.06	0.05	0.04	0.04	0.03	0.02	0.02	0.02
240	0.41	0.13	0.08	0.05	0.04	0.03	0.03	0.03	0.02	0.02	0.01	0.01	0.01	0.01	0.01	0.01
260	0.43	0.13	0.08	0.05	0.04	0.03	0.03	0.03	0.02	0.02	0.01	0.01	0.01	0.01	0.01	0.01
280	0.45	0.13	0.08	0.06	0.04	0.03	0.03	0.03	0.02	0.02	0.01	0.01	0.01	0.01	0.01	0.01
300	0.48	0.14	0.08	0.06	0.04	0.03	0.03	0.03	0.02	0.02	0.01	0.01	0.01	0.01	0.01	0.01
320	0.50	0.14	0.08	0.06	0.04	0.04	0.03	0.03	0.02	0.02	0.01	0.01	0.01	0.01	0.01	0.01
340	0.53	0.14	0.08	0.06	0.04	0.04	0.03	0.03	0.02	0.02	0.01	0.01	0.01	0.01	0.01	0.01
360	0.56	0.14	0.08	0.06	0.04	0.04	0.03	0.03	0.02	0.02	0.01	0.01	0.01	0.01	0.01	0.01
380	0.59	0.14	0.08	0.06	0.04	0.04	0.03	0.03	0.02	0.02	0.01	0.01	0.01	0.01	0.01	0.01
400	0.62	0.15	0.08	0.06	0.04	0.04	0.03	0.03	0.02	0.02	0.01	0.01	0.01	0.01	0.01	0.01
420	0.66	0.15	0.08	0.06	0.04	0.04	0.03	0.03	0.02	0.02	0.01	0.01	0.01	0.01	0.01	0.01
440	0.70	0.15	0.08	0.06	0.04	0.04	0.03	0.03	0.02	0.02	0.01	0.01	0.01	0.01	0.01	0.01

Reporting Source Height ft	0.5°	1.0°	1.5°	2.0°	2.5°	3.0°	3.5°	4.0°	5.0°	6.0°	7.0°	8.0°	10.0°	12.0°	14.0°	16.0°
460	0.75	0.15	0.08	0.06	0.04	0.04	0.03	0.03	0.02	0.02	0.01	0.01	0.01	0.01	0.01	0.01
480	0.80	0.15	0.08	0.06	0.04	0.04	0.03	0.03	0.02	0.02	0.01	0.01	0.01	0.01	0.01	0.01
500	0.85	0.16	0.09	0.06	0.04	0.04	0.03	0.03	0.02	0.02	0.01	0.01	0.01	0.01	0.01	0.01
520	0.91	0.16	0.09	0.06	0.04	0.04	0.03	0.03	0.02	0.02	0.01	0.01	0.01	0.01	0.01	0.01
540	0.98	0.16	0.09	0.06	0.05	0.04	0.03	0.03	0.02	0.02	0.01	0.01	0.01	0.01	0.01	0.01
560	1.05	0.16	0.09	0.06	0.05	0.04	0.03	0.03	0.02	0.02	0.01	0.01	0.01	0.01	0.01	0.01
580	1.14	0.16	0.09	0.06	0.05	0.04	0.03	0.03	0.02	0.02	0.01	0.01	0.01	0.01	0.01	0.01
600	1.24	0.17	0.09	0.06	0.05	0.04	0.03	0.03	0.02	0.02	0.01	0.01	0.01	0.01	0.01	0.01
620	1.35	0.17	0.09	0.06	0.05	0.04	0.03	0.03	0.02	0.02	0.01	0.01	0.01	0.01	0.01	0.01
640	1.47	0.17	0.09	0.06	0.05	0.04	0.03	0.03	0.02	0.02	0.01	0.01	0.01	0.01	0.01	0.01
660	1.62	0.17	0.09	0.06	0.05	0.04	0.03	0.03	0.02	0.02	0.01	0.01	0.01	0.01	0.01	0.01
680	1.78	0.17	0.09	0.06	0.05	0.04	0.03	0.03	0.02	0.02	0.01	0.01	0.01	0.01	0.01	0.01
700	1.98	0.18	0.09	0.06	0.05	0.04	0.03	0.03	0.02	0.02	0.01	0.01	0.01	0.01	0.01	0.01
720	2.20	0.18	0.09	0.06	0.05	0.04	0.03	0.03	0.02	0.02	0.01	0.01	0.01	0.01	0.01	0.01
740	2.45	0.18	0.09	0.06	0.05	0.04	0.03	0.03	0.02	0.02	0.01	0.01	0.01	0.01	0.01	0.01
760	2.74	0.18	0.09	0.06	0.05	0.04	0.03	0.03	0.02	0.02	0.01	0.01	0.01	0.01	0.01	0.01
780	3.07	0.19	0.09	0.06	0.05	0.04	0.03	0.03	0.02	0.02	0.01	0.01	0.01	0.01	0.01	0.01
800	3.44	0.19	0.09	0.06	0.05	0.04	0.03	0.03	0.02	0.02	0.01	0.01	0.01	0.01	0.01	0.01
820	3.84	0.19	0.09	0.06	0.05	0.04	0.03	0.03	0.02	0.02	0.01	0.01	0.01	0.01	0.01	0.01
840	4.27	0.19	0.10	0.06	0.05	0.04	0.03	0.03	0.02	0.02	0.01	0.01	0.01	0.01	0.01	0.01
860	4.74	0.20	0.10	0.06	0.05	0.04	0.03	0.03	0.02	0.02	0.01	0.01	0.01	0.01	0.01	0.01
880	5.24	0.20	0.10	0.06	0.05	0.04	0.03	0.03	0.02	0.02	0.01	0.01	0.01	0.01	0.01	0.01
900	5.76	0.20	0.10	0.06	0.05	0.04	0.03	0.03	0.02	0.02	0.01	0.01	0.01	0.01	0.01	0.01
920	6.29	0.20	0.10	0.06	0.05	0.04	0.03	0.03	0.02	0.02	0.01	0.01	0.01	0.01	0.01	0.01
940	6.85	0.21	0.10	0.06	0.05	0.04	0.03	0.03	0.02	0.02	0.01	0.01	0.01	0.01	0.01	0.01
960	7.41	0.21	0.10	0.06	0.05	0.04	0.03	0.03	0.02	0.02	0.01	0.01	0.01	0.01	0.01	0.01
980	7.98	0.21	0.10	0.07	0.05	0.04	0.03	0.03	0.02	0.02	0.01	0.01	0.01	0.01	0.01	0.01
1000	8.56	0.21	0.10	0.07	0.05	0.04	0.03	0.03	0.02	0.02	0.01	0.01	0.01	0.01	0.01	0.01

Parachute Flare above the Horizon – Maximum Distance
Angle of Observation above the Horizon – Maximum Distance to the Flare (NM)

Reporting Source Height ft	0.5°	1.0°	1.5°	2.0°	2.5°	3.0°	3.5°	4.0°	5.0°	6.0°	7.0°	8.0°	10.0°	12.0°	14.0°	16.0°
10	18.69	10.84	7.44	5.63	4.52	3.77	3.23	2.82	2.25	1.87	1.60	1.40	1.12	0.92	0.79	0.68
20	19.16	10.98	7.49	5.65	4.52	3.76	3.22	2.81	2.25	1.87	1.60	1.39	1.11	0.92	0.78	0.68
30	19.50	11.08	7.52	5.65	4.51	3.75	3.21	2.80	2.23	1.86	1.59	1.38	1.10	0.91	0.78	0.68
40	19.77	11.14	7.53	5.65	4.50	3.74	3.20	2.79	2.22	1.85	1.58	1.37	1.09	0.91	0.77	0.67
50	20.01	11.19	7.54	5.64	4.49	3.73	3.18	2.78	2.21	1.83	1.57	1.37	1.09	0.90	0.77	0.66
60	20.22	11.23	7.53	5.62	4.47	3.71	3.17	2.76	2.20	1.82	1.55	1.36	1.08	0.89	0.76	0.66
70	20.40	11.26	7.53	5.61	4.45	3.69	3.15	2.74	2.18	1.81	1.54	1.35	1.07	0.89	0.75	0.65
80	20.57	11.28	7.51	5.59	4.43	3.67	3.13	2.73	2.17	1.80	1.53	1.34	1.06	0.88	0.75	0.65
90	20.73	11.29	7.50	5.57	4.41	3.65	3.11	2.71	2.15	1.78	1.52	1.33	1.05	0.87	0.74	0.64
100	20.87	11.30	7.48	5.54	4.39	3.63	3.09	2.69	2.14	1.77	1.51	1.31	1.04	0.86	0.73	0.64
110	21.00	11.31	7.46	5.52	4.37	3.61	3.07	2.67	2.12	1.76	1.50	1.30	1.04	0.86	0.73	0.63
120	21.12	11.30	7.44	5.49	4.34	3.59	3.05	2.65	2.10	1.74	1.49	1.29	1.03	0.85	0.72	0.63
130	21.23	11.30	7.41	5.47	4.32	3.56	3.03	2.64	2.09	1.73	1.47	1.28	1.02	0.84	0.72	0.62
140	21.33	11.29	7.39	5.44	4.29	3.54	3.01	2.62	2.07	1.71	1.46	1.27	1.01	0.83	0.71	0.62
150	21.43	11.28	7.36	5.41	4.27	3.52	2.99	2.60	2.06	1.70	1.45	1.26	1.00	0.83	0.70	0.61

Reporting Source Height ft	0.5°	1.0°	1.5°	2.0°	2.5°	3.0°	3.5°	4.0°	5.0°	6.0°	7.0°	8.0°	10.0°	12.0°	14.0°	16.0°
160	21.52	11.27	7.33	5.38	4.24	3.49	2.97	2.58	2.04	1.69	1.44	1.25	0.99	0.82	0.70	0.61
170	21.61	11.25	7.30	5.35	4.21	3.47	2.94	2.56	2.02	1.67	1.42	1.24	0.98	0.81	0.69	0.60
180	21.69	11.23	7.26	5.32	4.18	3.44	2.92	2.54	2.01	1.66	1.41	1.23	0.97	0.81	0.68	0.59
190	21.77	11.21	7.23	5.29	4.15	3.42	2.90	2.52	1.99	1.64	1.40	1.22	0.97	0.80	0.68	0.59
200	21.84	11.18	7.20	5.25	4.12	3.39	2.88	2.50	1.97	1.63	1.39	1.21	0.96	0.79	0.67	0.58
220	21.97	11.13	7.12	5.19	4.06	3.34	2.83	2.45	1.94	1.60	1.36	1.18	0.94	0.78	0.66	0.57
240	22.09	11.06	7.04	5.11	4.00	3.28	2.78	2.41	1.90	1.57	1.34	1.16	0.92	0.76	0.65	0.56
260	22.19	10.99	6.96	5.04	3.94	3.23	2.73	2.37	1.87	1.54	1.31	1.14	0.90	0.75	0.63	0.55
280	22.28	10.91	6.87	4.97	3.88	3.17	2.68	2.33	1.83	1.51	1.29	1.12	0.88	0.73	0.62	0.54
300	22.35	10.83	6.79	4.89	3.81	3.12	2.64	2.28	1.80	1.48	1.26	1.09	0.87	0.71	0.61	0.53
320	22.42	10.73	6.69	4.81	3.74	3.06	2.58	2.24	1.76	1.45	1.23	1.07	0.85	0.70	0.59	0.52
340	22.47	10.64	6.60	4.73	3.68	3.00	2.53	2.19	1.72	1.42	1.21	1.05	0.83	0.68	0.58	0.50
360	22.52	10.53	6.50	4.65	3.61	2.94	2.48	2.15	1.69	1.39	1.18	1.03	0.81	0.67	0.57	0.49
380	22.56	10.42	6.40	4.56	3.54	2.88	2.43	2.10	1.65	1.36	1.15	1.00	0.79	0.65	0.55	0.48
400	22.58	10.30	6.29	4.48	3.47	2.82	2.38	2.06	1.61	1.33	1.13	0.98	0.77	0.64	0.54	0.47
420	22.60	10.18	6.18	4.39	3.39	2.76	2.33	2.01	1.58	1.30	1.10	0.96	0.75	0.62	0.53	0.46
440	22.61	10.06	6.07	4.30	3.32	2.70	2.27	1.96	1.54	1.27	1.07	0.93	0.74	0.61	0.52	0.45
460	22.61	9.92	5.96	4.21	3.25	2.64	2.22	1.92	1.50	1.23	1.05	0.91	0.72	0.59	0.50	0.44
480	22.60	9.78	5.85	4.12	3.17	2.57	2.17	1.87	1.46	1.20	1.02	0.89	0.70	0.58	0.49	0.42
500	22.59	9.64	5.73	4.03	3.10	2.51	2.11	1.82	1.43	1.17	0.99	0.86	0.68	0.56	0.48	0.41
520	22.56	9.49	5.61	3.93	3.02	2.45	2.06	1.77	1.39	1.14	0.97	0.84	0.66	0.54	0.46	0.40
540	22.53	9.34	5.48	3.84	2.94	2.38	2.00	1.72	1.35	1.11	0.94	0.81	0.64	0.53	0.45	0.39
560	22.49	9.18	5.36	3.74	2.86	2.32	1.95	1.68	1.31	1.08	0.91	0.79	0.62	0.51	0.44	0.38
580	22.44	9.01	5.23	3.64	2.79	2.25	1.89	1.63	1.27	1.04	0.88	0.77	0.60	0.50	0.42	0.37
600	22.39	8.84	5.10	3.54	2.71	2.19	1.83	1.58	1.23	1.01	0.86	0.74	0.59	0.48	0.41	0.35
620	22.32	8.66	4.97	3.44	2.63	2.12	1.78	1.53	1.19	0.98	0.83	0.72	0.57	0.47	0.40	0.34
640	22.25	8.48	4.83	3.34	2.54	2.05	1.72	1.48	1.15	0.95	0.80	0.69	0.55	0.45	0.38	0.33
660	22.17	8.29	4.69	3.24	2.46	1.99	1.66	1.43	1.11	0.91	0.77	0.67	0.53	0.43	0.37	0.32
680	22.08	8.09	4.55	3.13	2.38	1.92	1.60	1.38	1.08	0.88	0.75	0.65	0.51	0.42	0.36	0.31
700	21.98	7.89	4.41	3.03	2.30	1.85	1.55	1.33	1.04	0.85	0.72	0.62	0.49	0.40	0.34	0.30
720	21.87	7.68	4.27	2.92	2.21	1.78	1.49	1.28	1.00	0.82	0.69	0.60	0.47	0.39	0.33	0.28
740	21.75	7.47	4.12	2.81	2.13	1.71	1.43	1.23	0.96	0.78	0.66	0.57	0.45	0.37	0.31	0.27
760	21.63	7.25	3.97	2.70	2.04	1.64	1.37	1.18	0.92	0.75	0.63	0.55	0.43	0.36	0.30	0.26
780	21.49	7.02	3.82	2.59	1.96	1.57	1.31	1.12	0.88	0.72	0.61	0.52	0.41	0.34	0.29	0.25
800	21.34	6.79	3.66	2.48	1.87	1.50	1.25	1.07	0.83	0.68	0.58	0.50	0.39	0.32	0.27	0.24
820	21.18	6.54	3.50	2.37	1.78	1.43	1.19	1.02	0.79	0.65	0.55	0.47	0.37	0.31	0.26	0.23
840	21.01	6.29	3.34	2.25	1.69	1.36	1.13	0.97	0.75	0.62	0.52	0.45	0.35	0.29	0.25	0.21
860	20.82	6.04	3.18	2.14	1.61	1.29	1.07	0.92	0.71	0.58	0.49	0.43	0.33	0.28	0.23	0.20
880	20.62	5.77	3.02	2.02	1.52	1.21	1.01	0.87	0.67	0.55	0.46	0.40	0.32	0.26	0.22	0.19
900	20.41	5.50	2.85	1.90	1.43	1.14	0.95	0.81	0.63	0.51	0.43	0.38	0.30	0.24	0.21	0.18
920	20.18	5.21	2.68	1.79	1.34	1.07	0.89	0.76	0.59	0.48	0.41	0.35	0.28	0.23	0.19	0.17
940	19.94	4.92	2.51	1.67	1.24	0.99	0.83	0.71	0.55	0.45	0.38	0.33	0.26	0.21	0.18	0.15
960	19.68	4.62	2.33	1.54	1.15	0.92	0.76	0.65	0.51	0.41	0.35	0.30	0.24	0.19	0.17	0.14
980	19.39	4.31	2.15	1.42	1.06	0.84	0.70	0.60	0.46	0.38	0.32	0.28	0.22	0.18	0.15	0.13
1000	19.09	3.99	1.97	1.30	0.97	0.77	0.64	0.55	0.42	0.35	0.29	0.25	0.20	0.16	0.14	0.12

Parachute or Meteor Flare below the Horizon – Minimum Distance
Angle of Observation below the Horizon – Minimum Distance to the Flare (NM)

Reporting Source Height ft	0.5°	1.0°	1.5°	2.0°	2.5°	3.0°	3.5°	4.0°	5.0°	6.0°	7.0°	8.0°	10.0°	12.0°	14.0°	16.0°
10	0.17	0.09	0.06	0.05	0.04	0.03	0.03	0.02	0.02	0.02	0.01	0.01	0.01	0.01	0.01	0.01
20	0.16	0.09	0.06	0.05	0.04	0.03	0.03	0.02	0.02	0.02	0.01	0.01	0.01	0.01	0.01	0.01
30	0.16	0.09	0.06	0.04	0.04	0.03	0.03	0.02	0.02	0.02	0.01	0.01	0.01	0.01	0.01	0.01
40	0.15	0.08	0.06	0.04	0.04	0.03	0.03	0.02	0.02	0.02	0.01	0.01	0.01	0.01	0.01	0.01
50	0.15	0.08	0.06	0.04	0.04	0.03	0.03	0.02	0.02	0.02	0.01	0.01	0.01	0.01	0.01	0.01
60	0.15	0.08	0.06	0.04	0.04	0.03	0.03	0.02	0.02	0.02	0.01	0.01	0.01	0.01	0.01	0.01
70	0.15	0.08	0.06	0.04	0.04	0.03	0.03	0.02	0.02	0.02	0.01	0.01	0.01	0.01	0.01	0.01
80	0.14	0.08	0.06	0.04	0.04	0.03	0.03	0.02	0.02	0.02	0.01	0.01	0.01	0.01	0.01	0.01
90	0.14	0.08	0.06	0.04	0.04	0.03	0.03	0.02	0.02	0.02	0.01	0.01	0.01	0.01	0.01	0.01
100	0.14	0.08	0.06	0.04	0.04	0.03	0.03	0.02	0.02	0.02	0.01	0.01	0.01	0.01	0.01	0.01
110	0.14	0.08	0.06	0.04	0.04	0.03	0.03	0.02	0.02	0.02	0.01	0.01	0.01	0.01	0.01	0.01
120	0.14	0.08	0.06	0.04	0.03	0.03	0.03	0.02	0.02	0.02	0.01	0.01	0.01	0.01	0.01	0.01
130	0.13	0.08	0.06	0.04	0.03	0.03	0.03	0.02	0.02	0.02	0.01	0.01	0.01	0.01	0.01	0.01
140	0.13	0.08	0.06	0.04	0.03	0.03	0.03	0.02	0.02	0.02	0.01	0.01	0.01	0.01	0.01	0.01
150	0.13	0.08	0.05	0.04	0.03	0.03	0.03	0.02	0.02	0.02	0.01	0.01	0.01	0.01	0.01	0.01
160	0.13	0.08	0.05	0.04	0.03	0.03	0.03	0.02	0.02	0.02	0.01	0.01	0.01	0.01	0.01	0.01
170	0.13	0.08	0.05	0.04	0.03	0.03	0.03	0.02	0.02	0.02	0.01	0.01	0.01	0.01	0.01	0.01
180	0.13	0.08	0.05	0.04	0.03	0.03	0.03	0.02	0.02	0.02	0.01	0.01	0.01	0.01	0.01	0.01
190	0.13	0.08	0.05	0.04	0.03	0.03	0.03	0.02	0.02	0.02	0.01	0.01	0.01	0.01	0.01	0.01
200	0.13	0.08	0.05	0.04	0.03	0.03	0.03	0.02	0.02	0.02	0.01	0.01	0.01	0.01	0.01	0.01
220	0.12	0.07	0.05	0.04	0.03	0.03	0.03	0.02	0.02	0.01	0.01	0.01	0.01	0.01	0.01	0.01
240	0.12	0.07	0.05	0.04	0.03	0.03	0.02	0.02	0.02	0.01	0.01	0.01	0.01	0.01	0.01	0.01
260	0.12	0.07	0.05	0.04	0.03	0.03	0.02	0.02	0.02	0.01	0.01	0.01	0.01	0.01	0.01	0.01
280	0.36	0.22	0.16	0.12	0.10	0.09	0.07	0.07	0.05	0.04	0.04	0.03	0.03	0.02	0.02	0.02
300	0.59	0.36	0.26	0.20	0.17	0.14	0.12	0.11	0.09	0.07	0.06	0.06	0.05	0.04	0.03	0.03
320	0.81	0.50	0.36	0.28	0.23	0.20	0.17	0.15	0.12	0.10	0.09	0.08	0.06	0.05	0.05	0.04
340	1.04	0.64	0.47	0.36	0.30	0.25	0.22	0.20	0.16	0.13	0.12	0.10	0.08	0.07	0.06	0.05
360	1.26	0.78	0.57	0.44	0.37	0.31	0.27	0.24	0.19	0.16	0.14	0.12	0.10	0.08	0.07	0.06
380	1.47	0.92	0.67	0.52	0.43	0.37	0.32	0.28	0.23	0.19	0.17	0.15	0.12	0.10	0.08	0.07
400	1.68	1.05	0.76	0.60	0.50	0.42	0.37	0.32	0.26	0.22	0.19	0.17	0.14	0.11	0.10	0.08
420	1.89	1.18	0.86	0.68	0.56	0.48	0.41	0.37	0.30	0.25	0.22	0.19	0.15	0.13	0.11	0.10
440	2.10	1.32	0.96	0.76	0.62	0.53	0.46	0.41	0.33	0.28	0.24	0.21	0.17	0.14	0.12	0.11
460	2.30	1.45	1.06	0.83	0.69	0.59	0.51	0.45	0.37	0.31	0.27	0.23	0.19	0.16	0.13	0.12
480	2.50	1.58	1.15	0.91	0.75	0.64	0.56	0.49	0.40	0.34	0.29	0.26	0.21	0.17	0.15	0.13
500	2.70	1.70	1.25	0.99	0.81	0.69	0.60	0.54	0.44	0.37	0.32	0.28	0.22	0.19	0.16	0.14
520	2.89	1.83	1.34	1.06	0.88	0.75	0.65	0.58	0.47	0.40	0.34	0.30	0.24	0.20	0.17	0.15
540	3.08	1.96	1.44	1.14	0.94	0.80	0.70	0.62	0.50	0.42	0.37	0.32	0.26	0.22	0.19	0.16
560	3.27	2.08	1.53	1.21	1.00	0.86	0.75	0.66	0.54	0.45	0.39	0.34	0.28	0.23	0.20	0.17
580	3.46	2.21	1.62	1.29	1.06	0.91	0.79	0.70	0.57	0.48	0.42	0.37	0.30	0.25	0.21	0.18
600	3.65	2.33	1.72	1.36	1.13	0.96	0.84	0.74	0.61	0.51	0.44	0.39	0.31	0.26	0.22	0.20
620	3.83	2.45	1.81	1.43	1.19	1.01	0.88	0.78	0.64	0.54	0.47	0.41	0.33	0.28	0.24	0.21
640	4.02	2.58	1.90	1.51	1.25	1.07	0.93	0.83	0.67	0.57	0.49	0.43	0.35	0.29	0.25	0.22
660	4.20	2.70	1.99	1.58	1.31	1.12	0.98	0.87	0.71	0.60	0.52	0.45	0.37	0.31	0.26	0.23
680	4.38	2.82	2.08	1.65	1.37	1.17	1.02	0.91	0.74	0.62	0.54	0.48	0.38	0.32	0.27	0.24
700	4.55	2.94	2.17	1.73	1.43	1.22	1.07	0.95	0.77	0.65	0.56	0.50	0.40	0.33	0.29	0.25
720	4.73	3.05	2.26	1.80	1.49	1.28	1.11	0.99	0.81	0.68	0.59	0.52	0.42	0.35	0.30	0.26
740	4.91	3.17	2.35	1.87	1.55	1.33	1.16	1.03	0.84	0.71	0.61	0.54	0.44	0.36	0.31	0.27
760	5.08	3.29	2.44	1.94	1.61	1.38	1.21	1.07	0.87	0.74	0.64	0.56	0.45	0.38	0.32	0.28

Reporting Source Height ft	0.5°	1.0°	1.5°	2.0°	2.5°	3.0°	3.5°	4.0°	5.0°	6.0°	7.0°	8.0°	10.0°	12.0°	14.0°	16.0°
780	5.25	3.40	2.53	2.01	1.67	1.43	1.25	1.11	0.91	0.77	0.66	0.58	0.47	0.39	0.34	0.29
800	5.42	3.52	2.62	2.09	1.73	1.48	1.30	1.15	0.94	0.79	0.69	0.61	0.49	0.41	0.35	0.31
820	5.59	3.64	2.70	2.16	1.79	1.54	1.34	1.19	0.97	0.82	0.71	0.63	0.51	0.42	0.36	0.32
840	5.76	3.75	2.79	2.23	1.85	1.59	1.39	1.23	1.01	0.85	0.74	0.65	0.52	0.44	0.37	0.33
860	5.92	3.86	2.88	2.30	1.91	1.64	1.43	1.27	1.04	0.88	0.76	0.67	0.54	0.45	0.39	0.34
880	6.09	3.98	2.97	2.37	1.97	1.69	1.48	1.31	1.07	0.91	0.78	0.69	0.56	0.47	0.40	0.35
900	6.25	4.09	3.05	2.44	2.03	1.74	1.52	1.35	1.11	0.93	0.81	0.71	0.58	0.48	0.41	0.36
920	6.42	4.20	3.14	2.51	2.09	1.79	1.57	1.39	1.14	0.96	0.83	0.73	0.59	0.50	0.43	0.37
940	6.58	4.31	3.22	2.58	2.15	1.84	1.61	1.43	1.17	0.99	0.86	0.76	0.61	0.51	0.44	0.38
960	6.74	4.42	3.31	2.65	2.21	1.89	1.66	1.47	1.20	1.02	0.88	0.78	0.63	0.52	0.45	0.39
980	6.90	4.53	3.39	2.71	2.26	1.94	1.70	1.51	1.24	1.05	0.91	0.80	0.64	0.54	0.46	0.40
1000	7.06	4.64	3.48	2.78	2.32	1.99	1.74	1.55	1.27	1.07	0.93	0.82	0.66	0.55	0.48	0.41

Distances for Hand-held Flares (NM)

Reporting Source Height ft	0.5°	1.0°	1.5°	2.0°	2.5°	3.0°	3.5°	4.0°	5.0°	6.0°	7.0°	8.0°	10.0°	12.0°	14.0°	16.0°
10	0.00	0.00	0.00	0.00	0.00	0.00	0.00	0.00	0.00	0.00	0.00	0.00	0.00	0.00	0.00	0.00
20	0.16	0.09	0.06	0.05	0.04	0.03	0.03	0.02	0.02	0.02	0.01	0.01	0.01	0.01	0.01	0.01
30	0.32	0.17	0.12	0.09	0.07	0.06	0.05	0.05	0.04	0.03	0.03	0.02	0.02	0.02	0.01	0.01
40	0.46	0.25	0.18	0.13	0.11	0.09	0.08	0.07	0.06	0.05	0.04	0.03	0.03	0.02	0.02	0.02
50	0.61	0.34	0.23	0.18	0.14	0.12	0.10	0.09	0.07	0.06	0.05	0.05	0.04	0.03	0.03	0.02
60	0.75	0.42	0.29	0.22	0.18	0.15	0.13	0.11	0.09	0.08	0.07	0.06	0.05	0.04	0.03	0.03
70	0.88	0.49	0.34	0.26	0.21	0.18	0.15	0.14	0.11	0.09	0.08	0.07	0.06	0.05	0.04	0.03
80	1.01	0.57	0.40	0.31	0.25	0.21	0.18	0.16	0.13	0.11	0.09	0.08	0.06	0.05	0.05	0.04
90	1.14	0.65	0.45	0.35	0.28	0.24	0.21	0.18	0.15	0.12	0.10	0.09	0.07	0.06	0.05	0.05
100	1.27	0.72	0.51	0.39	0.32	0.27	0.23	0.20	0.16	0.14	0.12	0.10	0.08	0.07	0.06	0.05
110	1.40	0.80	0.56	0.43	0.35	0.30	0.26	0.22	0.18	0.15	0.13	0.11	0.09	0.08	0.07	0.06
120	1.52	0.87	0.61	0.47	0.38	0.32	0.28	0.25	0.20	0.17	0.14	0.13	0.10	0.08	0.07	0.06
130	1.64	0.95	0.67	0.51	0.42	0.35	0.31	0.27	0.22	0.18	0.16	0.14	0.11	0.09	0.08	0.07
140	1.76	1.02	0.72	0.56	0.45	0.38	0.33	0.29	0.23	0.20	0.17	0.15	0.12	0.10	0.08	0.07
150	1.88	1.09	0.77	0.60	0.49	0.41	0.35	0.31	0.25	0.21	0.18	0.16	0.13	0.11	0.09	0.08
160	2.00	1.16	0.82	0.64	0.52	0.44	0.38	0.33	0.27	0.23	0.19	0.17	0.14	0.11	0.10	0.08
170	2.11	1.23	0.87	0.68	0.55	0.47	0.40	0.36	0.29	0.24	0.21	0.18	0.15	0.12	0.10	0.09
180	2.23	1.31	0.93	0.72	0.59	0.49	0.43	0.38	0.31	0.26	0.22	0.19	0.15	0.13	0.11	0.10
190	2.34	1.38	0.98	0.76	0.62	0.52	0.45	0.40	0.32	0.27	0.23	0.20	0.16	0.14	0.12	0.10
200	2.45	1.45	1.03	0.80	0.65	0.55	0.48	0.42	0.34	0.29	0.25	0.22	0.17	0.14	0.12	0.11
220	2.67	1.58	1.13	0.88	0.72	0.61	0.53	0.46	0.38	0.31	0.27	0.24	0.19	0.16	0.14	0.12
240	2.89	1.72	1.23	0.96	0.78	0.66	0.57	0.51	0.41	0.34	0.30	0.26	0.21	0.17	0.15	0.13
260	3.10	1.85	1.33	1.03	0.85	0.72	0.62	0.55	0.44	0.37	0.32	0.28	0.23	0.19	0.16	0.14
280	3.31	1.99	1.43	1.11	0.91	0.77	0.67	0.59	0.48	0.40	0.35	0.30	0.24	0.20	0.17	0.15
300	3.51	2.12	1.52	1.19	0.98	0.83	0.72	0.63	0.51	0.43	0.37	0.33	0.26	0.22	0.19	0.16
320	3.72	2.25	1.62	1.27	1.04	0.88	0.77	0.68	0.55	0.46	0.40	0.35	0.28	0.23	0.20	0.17
340	3.92	2.38	1.72	1.34	1.10	0.94	0.81	0.72	0.58	0.49	0.42	0.37	0.30	0.25	0.21	0.19
360	4.11	2.51	1.81	1.42	1.17	0.99	0.86	0.76	0.62	0.52	0.45	0.39	0.32	0.26	0.23	0.20
380	4.31	2.63	1.91	1.49	1.23	1.04	0.91	0.80	0.65	0.55	0.47	0.41	0.33	0.28	0.24	0.21
400	4.50	2.76	2.00	1.57	1.29	1.10	0.95	0.84	0.69	0.58	0.50	0.44	0.35	0.29	0.25	0.22
420	4.69	2.88	2.09	1.64	1.35	1.15	1.00	0.89	0.72	0.61	0.52	0.46	0.37	0.31	0.26	0.23

Reporting Source Height ft	0.5°	1.0°	1.5°	2.0°	2.5°	3.0°	3.5°	4.0°	5.0°	6.0°	7.0°	8.0°	10.0°	12.0°	14.0°	16.0°
440	4.88	3.01	2.19	1.72	1.42	1.20	1.05	0.93	0.75	0.63	0.55	0.48	0.39	0.32	0.28	0.24
460	5.06	3.13	2.28	1.79	1.48	1.26	1.09	0.97	0.79	0.66	0.57	0.50	0.40	0.34	0.29	0.25
480	5.24	3.25	2.37	1.87	1.54	1.31	1.14	1.01	0.82	0.69	0.60	0.52	0.42	0.35	0.30	0.26
500	5.43	3.37	2.46	1.94	1.60	1.36	1.19	1.05	0.85	0.72	0.62	0.55	0.44	0.37	0.31	0.27
520	5.60	3.49	2.55	2.01	1.66	1.42	1.23	1.09	0.89	0.75	0.65	0.57	0.46	0.38	0.33	0.28
540	5.78	3.61	2.64	2.08	1.72	1.47	1.28	1.13	0.92	0.78	0.67	0.59	0.47	0.40	0.34	0.30
560	5.96	3.73	2.73	2.16	1.78	1.52	1.32	1.17	0.95	0.80	0.70	0.61	0.49	0.41	0.35	0.31
580	6.13	3.85	2.82	2.23	1.84	1.57	1.37	1.21	0.99	0.83	0.72	0.63	0.51	0.43	0.36	0.32
600	6.31	3.97	2.91	2.30	1.90	1.62	1.42	1.25	1.02	0.86	0.74	0.65	0.53	0.44	0.38	0.33
620	6.48	4.08	3.00	2.37	1.96	1.68	1.46	1.29	1.05	0.89	0.77	0.68	0.54	0.45	0.39	0.34
640	6.65	4.20	3.09	2.44	2.02	1.73	1.51	1.34	1.09	0.92	0.79	0.70	0.56	0.47	0.40	0.35
660	6.82	4.31	3.17	2.51	2.08	1.78	1.55	1.38	1.12	0.95	0.82	0.72	0.58	0.48	0.41	0.36
680	6.98	4.43	3.26	2.59	2.14	1.83	1.60	1.42	1.15	0.97	0.84	0.74	0.60	0.50	0.43	0.37
700	7.15	4.54	3.35	2.66	2.20	1.88	1.64	1.46	1.19	1.00	0.87	0.76	0.61	0.51	0.44	0.38
720	7.32	4.66	3.44	2.73	2.26	1.93	1.69	1.50	1.22	1.03	0.89	0.78	0.63	0.53	0.45	0.39
740	7.48	4.77	3.52	2.80	2.32	1.98	1.73	1.54	1.25	1.06	0.92	0.81	0.65	0.54	0.46	0.41
760	7.64	4.88	3.61	2.87	2.38	2.03	1.78	1.58	1.29	1.09	0.94	0.83	0.67	0.56	0.48	0.42
780	7.80	4.99	3.69	2.94	2.44	2.08	1.82	1.62	1.32	1.11	0.96	0.85	0.68	0.57	0.49	0.43
800	7.96	5.10	3.78	3.00	2.50	2.13	1.86	1.66	1.35	1.14	0.99	0.87	0.70	0.59	0.50	0.44
820	8.12	5.21	3.86	3.07	2.55	2.18	1.91	1.70	1.38	1.17	1.01	0.89	0.72	0.60	0.51	0.45
840	8.28	5.32	3.95	3.14	2.61	2.24	1.95	1.73	1.42	1.20	1.04	0.91	0.74	0.62	0.53	0.46
860	8.44	5.43	4.03	3.21	2.67	2.29	2.00	1.77	1.45	1.23	1.06	0.93	0.75	0.63	0.54	0.47
880	8.59	5.54	4.12	3.28	2.73	2.34	2.04	1.81	1.48	1.25	1.08	0.96	0.77	0.64	0.55	0.48
900	8.75	5.65	4.20	3.35	2.79	2.39	2.09	1.85	1.51	1.28	1.11	0.98	0.79	0.66	0.56	0.49
920	8.90	5.76	4.28	3.42	2.84	2.43	2.13	1.89	1.55	1.31	1.13	1.00	0.81	0.67	0.58	0.50
940	9.05	5.86	4.36	3.48	2.90	2.48	2.17	1.93	1.58	1.34	1.16	1.02	0.82	0.69	0.59	0.52
960	9.21	5.97	4.45	3.55	2.96	2.53	2.22	1.97	1.61	1.36	1.18	1.04	0.84	0.70	0.60	0.53
980	9.36	6.08	4.53	3.62	3.01	2.58	2.26	2.01	1.64	1.39	1.20	1.06	0.86	0.72	0.61	0.54
1000	9.51	6.12	4.61	3.69	3.07	2.63	2.30	2.05	1.68	1.42	1.23	1.08	0.87	0.73	0.63	0.55

Appendix Q

Sample problem

- Amend **Leeway (LW) worksheet** on page Q7 as follows:

Leeway (LW) worksheet

Case title F/V SAMPLE Case number 00-001 Date 26 JAN 2000
Planner's name SAR SCHOOL Datum number 1 Search plan A B C A
Search object Medium displacement fishing vessel

1	Average surface wind (ASW) (from Datum worksheet, line C.1)	<u>194</u> °T	<u>31.72</u> kts
2	Downwind direction (ASW direction ± 180°)		<u>014</u> °T
3	Leeway speed (from figure N-2 or N-3)		<u>1.13</u> kts
4	Leeway divergence angle (from figure N-2 or N-3)		± <u>50</u> °
5	Leeway directions		
	a Left of downwind (line 2 – line 4)		<u>324</u> °T
	b Right of downwind (line 2 + line 4)		<u>064</u> °T
6	Leeway (LW)		
	a Left of downwind	<u>324</u> °T	<u>1.3</u> kts
	b Right of downwind	<u>064</u> °T	<u>1.3</u> kts
7	Probable leeway error (LW _e) (from figure N-2 or N-3)		<u>0.3</u> kts
8	Go to part E on the Datum worksheet .		

Appendix R

Medical assistance at sea, TMAS – TMAS Medical information exchange form

- Amend Appendix R – Medical assistance at sea, TMAS – TMAS Medical information exchange form as follows

Confidential Private medical information

Patient

(Modified to conform with national data protection laws or regulations.)

Nationality:

Spoken language:

Medical circumstances

	Time of onset of injury / illness:	
	Mechanism of injury (if applicable):	
	Injuries suspected / working diagnosis:	
	Signs and symptoms	
	Heart rate	
	Blood pressure	
	Respiratory rate	
	O2 saturation	
	Conscious level: GCS or AVPU	
	Treatment administered and care given on board before evacuation	
	Patient height (meters)	
	Patient weight (Kg)	

	Is patient obese?	
	Are there known additional risks for medical evacuation?	
	Is patient able to wear an immersion suit? (for helicopter/rescue boat evacuation)	
	Does patient need to be carried and transported on stretcher?	
	Is condition contagious?	
	Is the patient's mental state altered? If yes please confirm patient consent for: - transport in a stretcher - intravenous cannulation prior to transfer	
Previous Medical History	Ongoing Treatments	Care on board before teleconsultation

Diagnosis given:

.....

Identification of the requiring TMAS

Name:.....
 Address:..... Tel:.....
 Fax:.....

..... Email:.....

Medical instructions

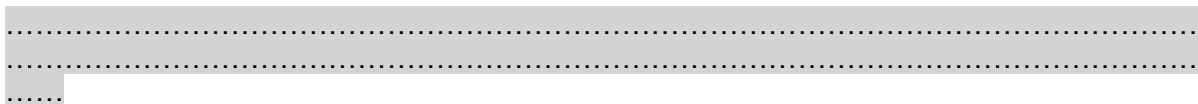

Medical assistance required

<p>Medical decision:</p> <p>Ship diversion to port (name):</p> <p>Ambulance:</p> <p>Medical team: Doctor / Nurse / Paramedic (Delete as required)</p>	<p>Medical Evacuation:</p> <p>MEDEVAC Time Frame:</p> <p>Immediate / Daylight Hours within 6, 12, 24 hours, etc. (Delete as required)</p> <p>MEDEVAC method (Delete as required): Boat / Helicopter: Land on / Winch by Stretcher / Winch by strop</p>
<p>Additional Information if required:</p>	<p>Additional information if required:</p>
<p>Air drop of supplies:</p>	<p>Quarantine situation:</p>

Ship Vessel Details

Ship Name:	Call-sign: IMO number:
Type:	Flag:
Location:	Departure DTG:
Port of origin Ports visited during the last 30 days	
Destination:	ETA DTG:
Contact:	

Please send back all the available follow-up Information to:

TMAS Name:

Tel:

Address:

Fax:

Email:

Appendix T

Checklists and guides for multiple aircraft SAR operations

- Amend Appendix T as follows:

Page T-iACO procedure form – Mass-rescue Multiple aircraft SAR operations

ACO procedure form – Mass-rescue Multiple aircraft SAR operations

GENERAL INFORMATION	
OPERATION	
EMERGENCY LOCATION	
IDENTIFICATION (VERSION)	
TIME ZONE	
ACO INFORMATION	
ACO CALLSIGN	
ACO FREQUENCY	
ACO TEL/EMAIL	
WAYPOINTS	
REFERENCE POINT	
ENTRY POINT	
FINAL APPROACH POINT	
EXIT POINT	
HOLDING POINT 1	
HOLDING POINT 2	
EVACUATION SITE 1	
EVACUATION SITE 2	
REFUELING	
CREW SUPPORT	
ALTITUDES	
ENROUTE/ENTRY	
HOLDING POINT(S)	
FINAL APPROACH POINT	
EXIT POINT	
MISSED APPROACH.	
APPROACH FALLBACK PROCEDURE	
ENROUTE/LEAVING AREA	
NATURE OF DISTRESS AND/OR SEARCH OBJECTS	
SAFETY BRIEF	
<p><i>"The Air Coordinator will only provide advisory information. You (Pilot-in-command) are responsible for the safety of your own aircraft at all times. If you, because of safety reasons, are unable to comply with instructions given by ACO, you are to notify me (ACO) immediately."</i></p>	

PICTURE OF ACO PROCEDURE	
MISSED APPROACH PROCEDURE APPROACH FALLBACK PROCEDURE	
HOIST POSITIONS ON SCENE	
WEATHER ON SCENE	QNH

Pilot Information File

AIR COORDINATOR 123,100 MHz

ENTRY REPORT / 20 NM before reaching area!

1. Callsign
2. Nationality
3. Type (FIXED/HELICOPTER AND TYPE)
4. Position
5. Altitude and pressure setting
6. ETA (RELEVANT POINT OR SEARCH AREA)
7. Endurance on scene
8. Remarks (EQUIPMENT – LIMITATIONS)
9. POB (crew, other personnel)

REPORTING

- **Reaching** assigned points.
- **Leaving** assigned points.
- **Commencing** operations (search, investigation during search, approach to surface/ship, missed approach fallback procedure, hoist, landing etc.).
- **Completing** operations, including information regarding results.
- Leaving present altitude.
- Reaching new altitude.
- 10 minutes to completing hoist operation or search.
- 30 minutes on scene endurance, expecting fuel at (location)
- Exit Report: PAX, ETA and requirements at destination, ETA back in operations area and any remarks (hoist position and weather)

SEARCH MISSION

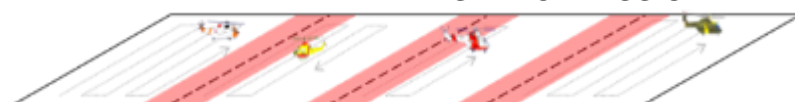

- Coordination zones – example 1 NM on each side of border
Call neighbouring helo: before entering coordination zone
+when exiting 1NM buffer
2. No fly zones: Do no enter buffer zone.

NOTE:

The ACO provides only **ADVISORY** information, **pilots-in-command aircraft commanders** are responsible for the safety of own aircraft.
Notify ACO immediately if unable to comply with instructions received.

Appendix U

Mobile telecommunications device location process

U1.

- U1.1** The services available to mobile telecommunications device users utilize terrestrial radio systems which are then linked to large computer servers which, amongst other functions, record: activity; cell-site to which a user is connected; and general location of the user. This information provides data which is of use to Search and Rescue authorities who may need to identify the location of persons in actual or possible danger, e.g. overdue vessel, aircraft or missing persons on land.
- U1.2** Mobile/Cellular telecommunications devices have also become a popular means of reporting emergencies either at sea or on land, in the coastal environment and/or other remote areas, e.g. swimmers, surfers, overdue hikers, climbers, etc. Leisure boaters, aviators and small fishing craft might report their emergencies by cell/mobile phone and these devices can often provide an effective signal over considerable areas, depending on the location, height and power of the terrestrial aerial infrastructure.
- U1.3** Survivors from distressed vessels or crashed aircraft may be able to use mobile telecommunications devices to call for assistance or their devices may remain switched on and may provide signals that can be detected by the cell/mobile telecommunications system. The development of procedures to exploit location data from these devices to determine survivor location is important for effective SAR response, particularly when other sources of location information are not available or are inconsistent or inaccurate.
- U1.4** This annex is focused on search planning techniques for situations where a mobile telecommunications device can only be located using the terrestrial radio signal information obtained from the aerial site the device was or is connected to. Where Global Navigation Satellite Systems (GNSS) information is available on the location of a mobile telecommunications device (i.e. the user has a GNSS enabled device), the SMC may be able to apply normal search planning procedures and techniques to the GNSS position. However, information on the cell-site signal location may also be a useful confirmation of a GNSS position.
- U1.5** The processes outlined below are offered as manual search planning processes and do not take into account any computerized search planning computer systems or applications.

Mobile Telecommunications Device Location Process

U1.6 Mobile telecommunications aerial (cell) sites are commonly fitted with three aerials² (covering 360° in azimuth) which provide the mast/cell with three communications "sectors" (each of 120° of arc) on which mobile/cell phone calls and data traffic can be exchanged or mobile/cell phones/devices can be polled.³ For SAR purposes this usually means that, as a minimum, a mobile/cell device can be located to within a particular aerial site "sector". This is, essentially, a crude direction-finding method but with a large arc of error.

U1.6.1 RCCs are recommended to establish what types of systems are in use in their SRRs and ensure that they understand the technical processes and how those systems can be used to provide data of use to SAR response and search planning.



Figure 1: A mobile telecommunications mast with three aerials – therefore three "sectors"

U1.7 For 4G-capable mobile phones or devices within coverage of a 4G network cell/tower, Mobile Communications service providers may also be able to provide information on the distance of the phone or device from the cell/tower. This then provides the ability to plot an arc within a particular aerial site sector.

Mobile Telecommunications Devices are Radio Transmitters

U1.8 Mobile telecommunications devices are radio transmitters: this means that the signals behave in a similar way to VHF radio signals – they tend to work over "line of sight" to and from the aerial/mast site. The signals can however be distorted, reflected, propagated (by atmospheric conditions or their position in relation to bodies of water) or shielded by buildings, passing traffic or terrain. This creates a particular problem with emergency calls from mobile telecommunications devices in that the communications data might "predict" that a phone is within the coverage of a mobile telecommunications aerial site but, it can also be the case that the phone or device is connected to the aerial from outside the normally predicted coverage.

² This may not be the case globally and some aerial sites have more aerials per mast, e.g. 6.

³ Mobile telecommunications systems 'poll' mobile devices on a periodic basis to establish the current location and status of a device. When a device is switched on or off or, if a location update has not been received for a set period of time or, a user makes or receives a call, text, data communication, etc. an update signal is exchanged with the nearest mast. This information is logged by the mobile telecommunications company computer servers. Each time a device moves in or out of range of a new aerial/mast, a new polling request is exchanged and the phones mast-location and, therefore, its sector, is updated.

U1.9 Mobile Communications service providers can provide terrain models of each aerial site and these can show, in more detail, any masking effects based on transmitter height and terrain contours, buildings, etc. between various locations in a cell tower's coverage area. It can be useful to ask providers to assist the RCC/MRCC in determining the area where the mobile communications device may be located.

Emergency Telephone Systems, Enhanced Call-Data

U1.10 Emergency telephone calls from mobile telecommunications emergency (e.g. 112, 999, 911) voice-calls may be routed through telecommunications systems that are able to automatically provide approximate location information to the emergency service operator. These systems usually give a predicted location area for a phone based on signal strength, aerial site location, transmitter power and surrounding terrain, buildings, etc. Such prediction areas are usually provided to emergency services in either a circle or an ellipse form, which can be plotted onto a chart or map. In reality they can be much more complex shapes depending of the scale of the terrain model used. However, these areas can be significantly inaccurate given other factors such as propagation, terrain masking, signal attenuation, etc. See figure 5 below for diagram.

Cell Site Information

U1.11 Mobile telecommunications companies can usually provide the following enhanced information about an emergency telephone or data call. National legislative procedures and processes may have to be followed to enable a RCC/MRCC to obtain such information e.g. such data may not be directly available to SAR coordination services and police or judicial assistance may have to be requested to obtain the information due to privacy laws, etc.

- a) cell site location – in the national map grid-reference system and/or in Latitude and Longitude;
- b) postal address of the site including the postal or Zip code;
- c) time that the information was valid for;
- d) whether the information is an incoming or outgoing call, text or data connection or was a polling location-update signal;
- e) the "sector" on which a mobile telecommunications device was connected or polled – this may be in one of two formats:
 - i) clock face, e.g. 12 o'clock to 5 o'clock;
 - ii) bearing method, e.g. 060 degrees; and
- f) for a 4G device within a 4G network, the distance of the device from the cell site location may be available.

U1.12 The "direction" information needs to be understood and interpreted before it can be used for search planning:

- a) The clock face method indicates that the sectors are laid out according to the 12 hour clock system, with each "hour" representing 30 compass degrees e.g. "sector from 4 o'clock to 8 o'clock" means from 120 to 240 degrees:

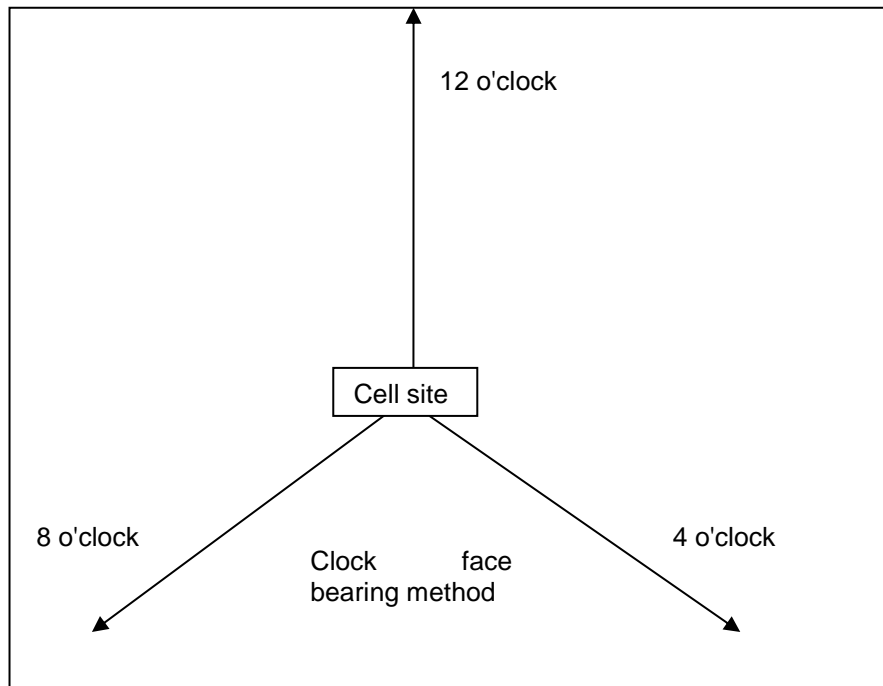

Figure 2. Cell site sector, clock face method, three sectors. Note: 12 o'clock is normally grid north⁴.

⁴ The orientation of a cell site compass direction must also be established, e.g. Grid North, True North, Magnetic North. This must then be applied to any search plan.

- b)** The "Bearing" method means the sector is reported as the centre line of a 120 degree-wide sector e.g. "sector bearing 060" means that the sector is from 000 degrees to 120 degrees (assuming site North is 000 degrees map-grid North); 60 degrees must be added and subtracted from the given-bearing to provide the aerial "sector". This assumes a three-aerial mast.

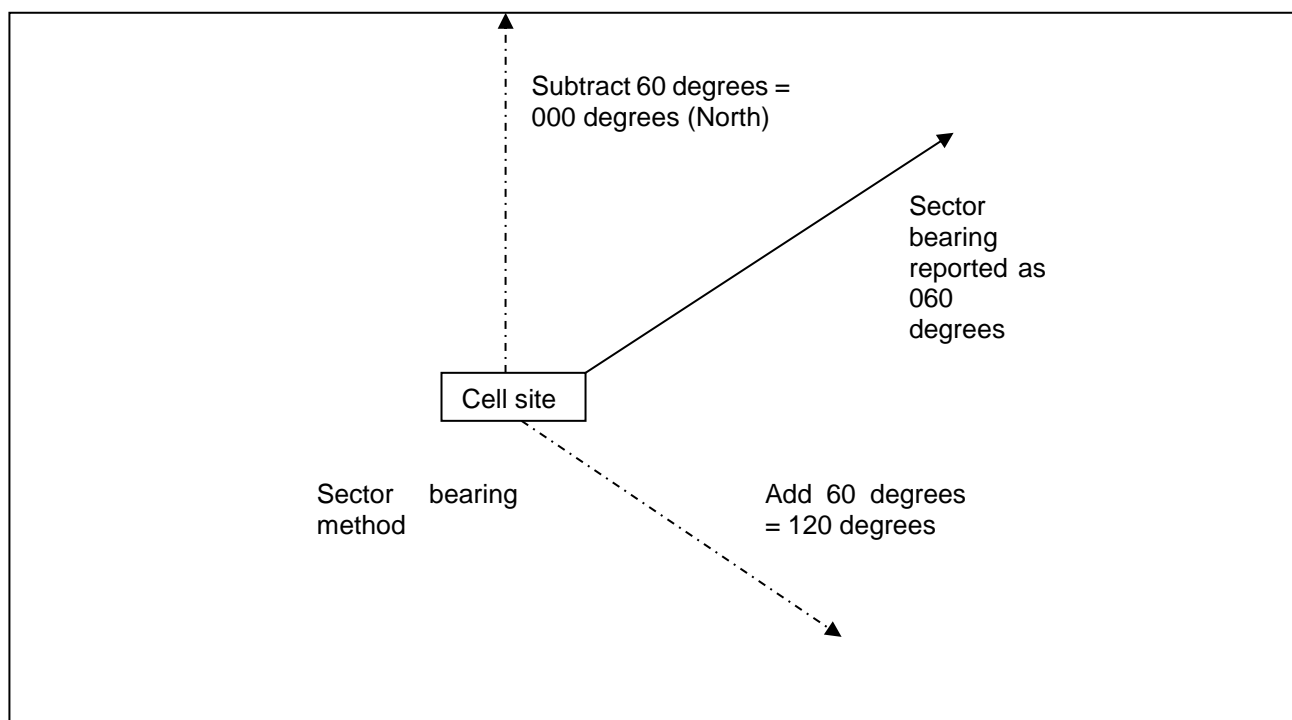

Figure 3: Cell site sector, bearing method

U1.13 The process of plotting and creating a (crude) manual search area from either "sector" format is to:

- a)** plot the location of the aerial site on a map or chart;
- b)** draw on the chart the sector bearing lines from the cell site to the maximum range that the cell site is predicted to cover, e.g. 10 kilometres;
- c)** scribe an arc, between the bearing lines, centred on the aerial site location to the maximum range the site can cover. This shape will look like a large cake-slice;
- d)** enclose the "cake slice" within a box;
- e)** calculate an appropriate Datum Time;
- f)** if the incident is over land, this area is now your search area. It may be necessary to move this area in accordance with estimated or likely movement if the survivors are known to be moving, e.g. walking;
- g)** for an aircraft, if the planned route is known, this may also be plotted to further reduce the search area;

- h)** if the incident is maritime, drift each corner of this box according to the appropriate tide/current(s) near to each corner (any corners "on land" will have to be drifted in approximation to the nearest coastal tides and currents);
- i)** add estimated, or known, leeway of the search object to the drift of each corner of the box;
- j)** increase the size of the search box in accordance with assessed Drift Error factor percentage. This can be done by expanding the sides of the box by the amount calculated. The final area is the search area; and
- k)** manually calculate Search Area Coverage for assigned SRUs.

U1.14 It should be noted that "drifting" corners is not always adequate. For example: This would not work very well in areas with a high current gradient, such as some bays, inlets, straits, etc. and the four corners of a box may not include a strong current in the middle, for example. The drift start points should be based on the best available knowledge of the local currents and winds to ensure a proper representation of possible drift trajectories.

U1.15 Use of drift buoys, such as Self Locating Datum Marker Buoys, may assist with validation of drift assumptions.

U1.16 This may lead to the "box" becoming distorted at the corners due to greater or lesser drift rates in different places.

See next page for an image of this process.

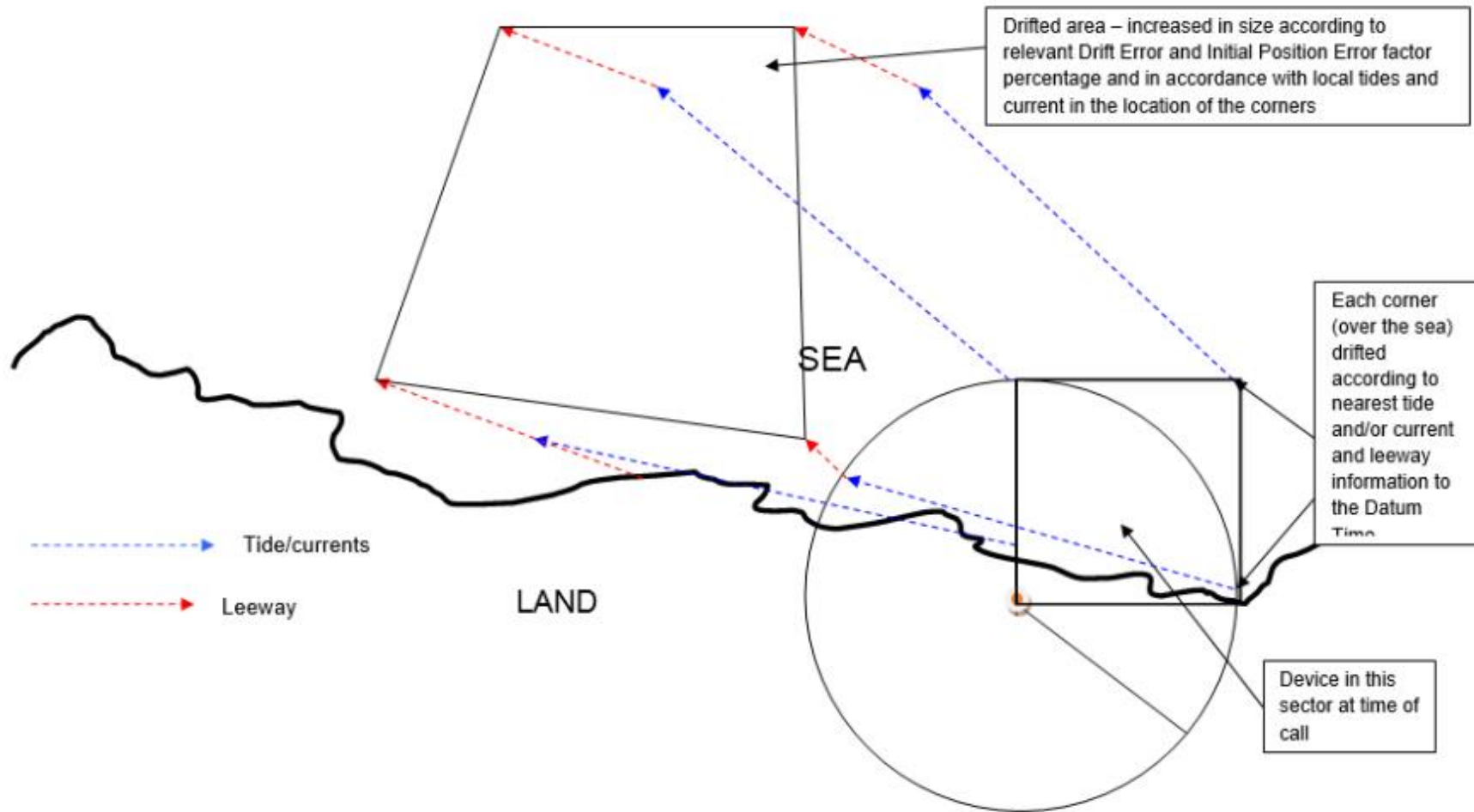

Figure 4: Search area created from mobile/cell telecommunications activity data

Enhanced Emergency Call Data Information Ellipse, Search Planning Process

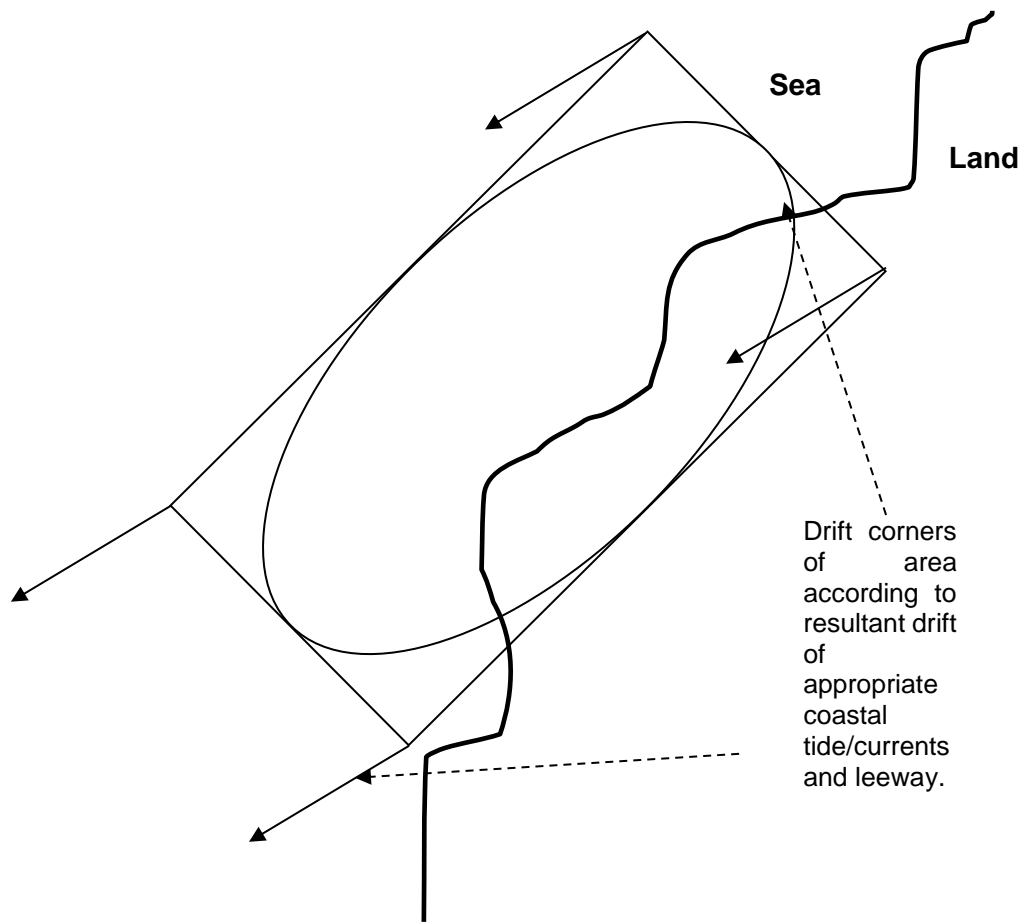

Figure 5: Enhanced emergency call data plotting and drifting

U1.17

- a) Plot enhanced call data service ellipse or circle onto chart or map.
- b) Enclose the ellipse or circle within a rectangle or square. Enclose the ellipse within a box and determine the latitudes and longitudes/grid positions of the corners and then plot onto a chart.
- c) If elapsed time from emergency call to arrival of SRUs on scene is long, drift the area to the chosen datum time according to tide/currents and known or estimated leeway for each corner.
- d) Where parts of the area are on land, drift the "land corners" according to the tide/current in the sea area nearest to those corners (this is a pragmatic, rough estimate search area and will require adequate additional error factors to be applied).
- e) Add appropriate Drift Error factor (%) size increase to the resultant rectangle.
- f) Allocate SRUs to the resultant area.

Datum Line Searches

- U1.18** Where a vessel or aircraft is overdue and is on a known or possible route, mobile device location data may provide clues to its location.
- U1.19** For example, an overdue vessel or aircraft is known to have set off on a route, travelling from north to south, between two places, but there is a large distance between them. The SMC wishes to reduce the size of the search area and obtains mobile telecommunications device data that indicates the vessel or aircraft had received a telephone call off a certain part of a coastline. This information can be plotted to provide the SMC with a Last Known Position from which to create a Datum Line search plan for the rest of the route.
- U1.20** The process explained in paragraph 12 above can be applied to develop a search area from this initial cell site information. Once this is done, normal Datum Line search planning processes (manual or computerized) can then be used to calculate a Datum Line search area along the rest of the vessel or aircraft's estimated route.
- U1.21** The Initial Position Error (IPE) is determined by measuring the largest distance across the "sector". A position in the middle of the "sector" should be chosen as the Drift Start Position (DSP) and the IPE then applied to this position.
- U1.22** The same process could be used for land incidents to determine the LKP of missing hikers, aircraft, vehicles, etc. on planned or known routes.

See diagram below for detail.

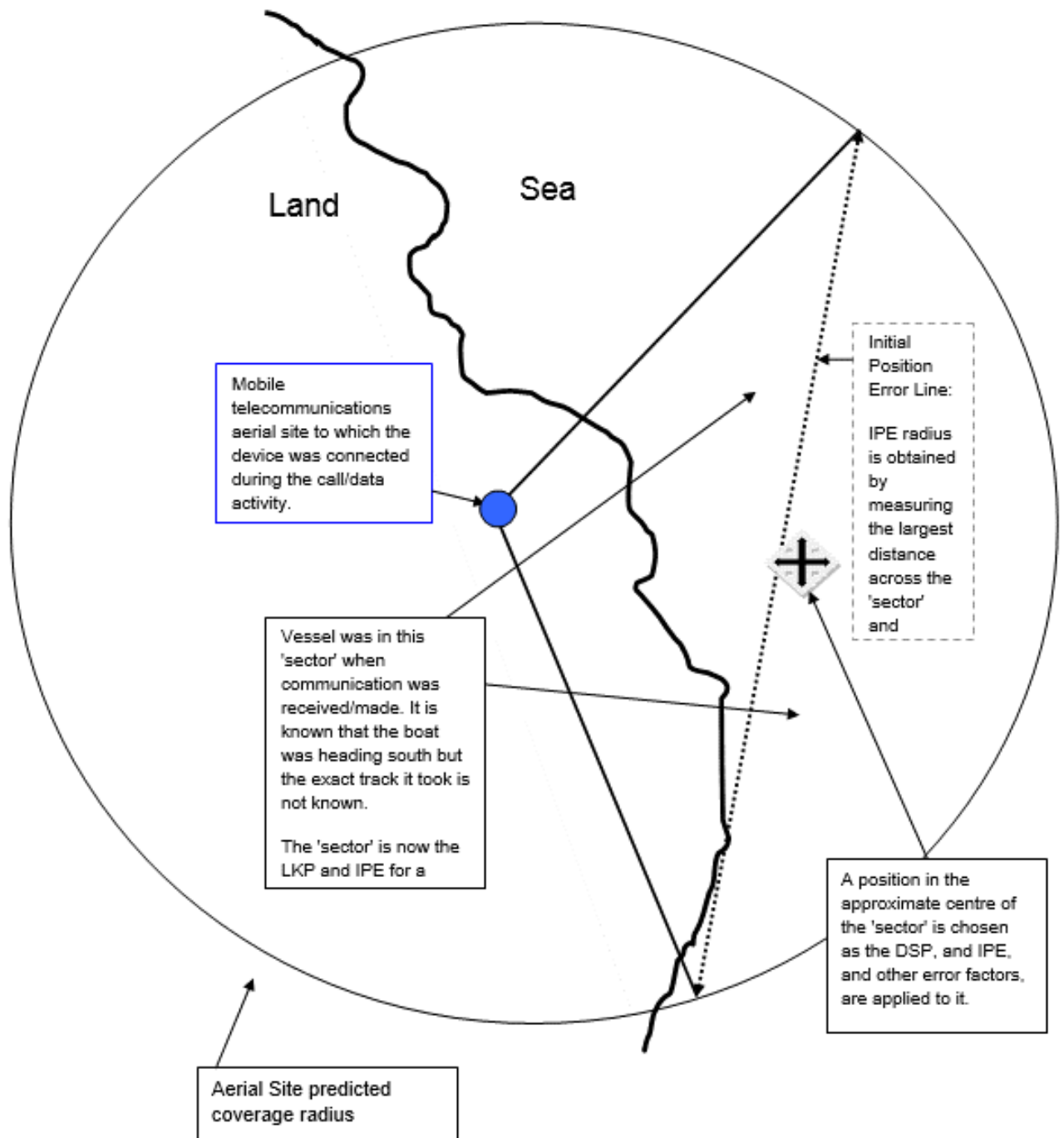

Figure 6: Using Mobile Telecommunications Data to Develop a Search Area

U1.23 It should be noted that a mobile communications device and mobile telecommunications aerial data constitute only one line of evidence about the vessel's position at the time of the call. Other lines of evidence include nautical chart information, especially data on soundings, aids to navigation, hazards to navigation, etc., along with any available information about the vessel's intended route, destination, experience, qualifications, predilections of the vessel's captain, etc. All of this information should be considered when estimating the most probable position at the time of the last communication, the probable error of that position and the most probable track(s) and speed(s) of advance thereafter.

Using Telecommunications Data to Reduce Size of a Datum Line Search Area

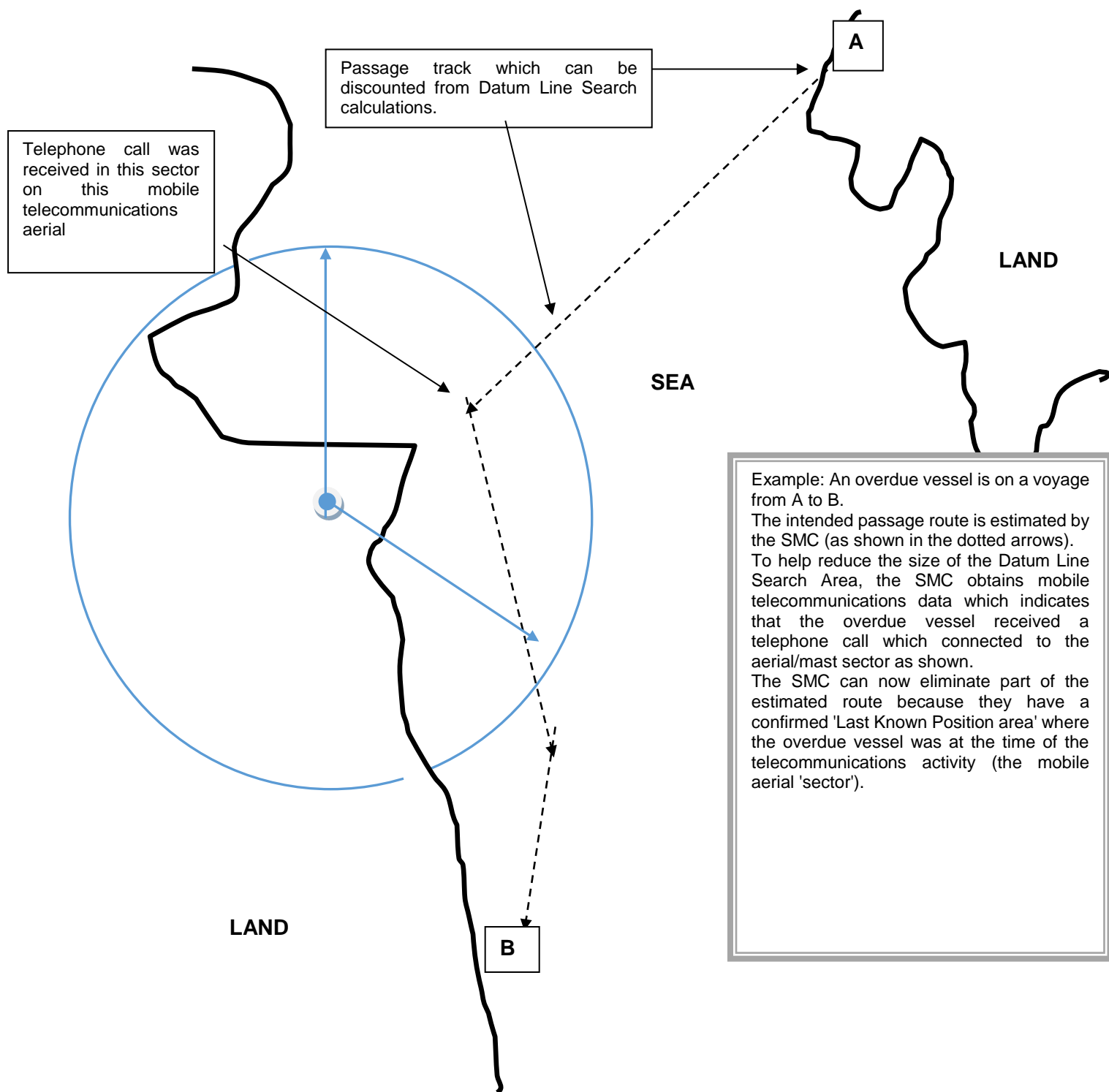

Figure 7: Using Mobile Telecommunications data to reduce the size of a Datum Line search area

U1.24 Mobile telecommunications device data can also provide RCCs with useful location information for overdue persons, vehicles or aircraft. Although mobile telecommunications devices may not be in use while an aircraft is in the air, it may be that persons on board use, or try to use, their cell/mobile phones once an aircraft has forced landed or, that mobile telecommunications devices are or become active at a crash or forced landing site. Light aircraft users may also leave cell/mobile devices switched on in flight and this may provide useful SAR clues if an aircraft is reported overdue or missing.

U1.25 In these scenarios, location data from these devices may assist SAR units and teams to locate a missing aircraft.

U1.26 It should be noted again that a cell-site signal propagation "map" for the cell-site tower, based on terrain and height of the mobile telecommunications devices above ground level, will be useful to help the search planner create a more accurate search area. Unless aircraft was airborne and moving at the time.

See example below.

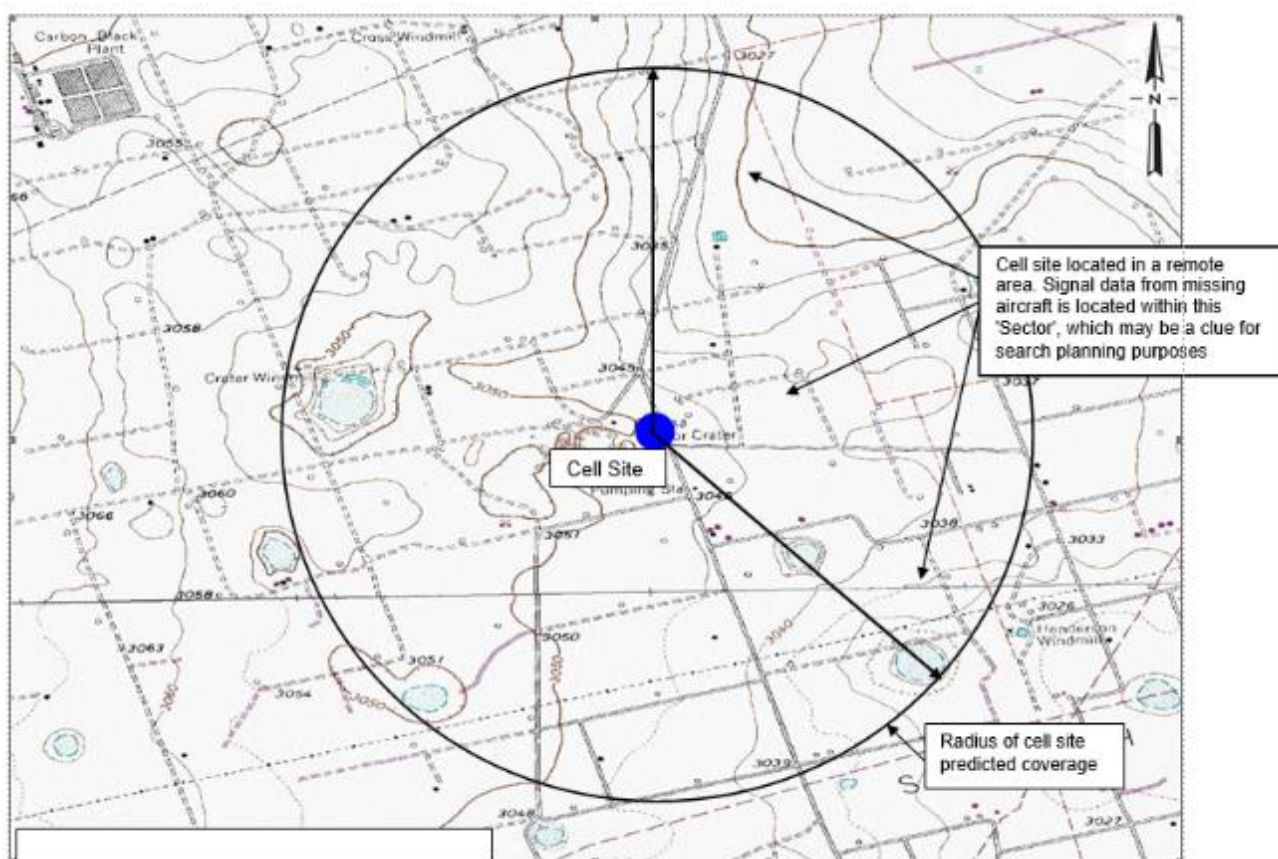

Figure 8: Mobile communications device aerial sector for land SAR scenario

AMENDMENTS TO IAMSAR MANUAL VOLUME III

Reorganized version

a. Contents

Foreword

Abbreviations and acronyms

Glossary

Section 1 Overview of the SAR system

Section 2 ~~Rendering assistance~~ Distress alerts and messages

Section 3 ~~On-scene coordination~~ Medical assistance

Section 4 ~~On-board emergencies~~ Vessel emergencies at sea

Section 5 ~~Multiple aircraft SAR operations~~ Aircraft emergencies

Section 6 Initial action by assisting vessels

Section 7 Initial action by assisting aircraft

Section 8 On-scene communications

Section 9 On Scene Coordinator

Section 10 Multiple aircraft SAR operations

Section 11 Aircraft Coordinator

Section 12 Searching

Section 13 Rescue action plan

Section 14 Rescue or assistance by vessels

Section 15 Rescue or assistance by aircraft

Section 16 Vessel / helicopter operations

Section 17 Underwater search and rescue

Section 18 Rescue on land

Section 19 Intercepts

Section 20 Survivors

Section 21 Deceased persons

Section 22 Public relations

Section 23 Training

Appendix A Regulation V/33 of the International Convention for the Safety of Life at Sea, 1974, as amended

Appendix B Search action message

Appendix C Factors affecting observer effectiveness

Appendix D Standard format for search and rescue situation report (SITREP)

Appendix E SAR briefing and debriefing form

Appendix F Own emergency

Appendix G Rendering assistance

Appendix H Multiple aircraft SAR operations

Abbreviations and acronyms

A	search area
A/C	aircraft
ACO	aircraft coordinator
AED	automated external defibrillator
AFTN	aeronautical fixed telecommunication network
AIP	aeronautical information publication
AIS	aeronautical information services
AIS	automatic identification system (radio navigation)
AIS-MOB	automatic identification system – man overboard
AIS-SART	automatic identification system – search and rescue transmitter
AM	amplitude modulation
ARCC	aeronautical rescue coordination centre
ATC	air traffic control
ATS	air traffic services
C	coverage factor
°C	degrees centigrade
CPR	cardiopulmonary resuscitation
CRS	coast radio station
C/S	call sign
CS	coast station
CS	creeping line search
CSC	creeping line search, coordinated
CSP	commence search point
CW	continuous wave
DF	direction finding
DMB	datum marker buoy
DR	dead reckoning
DSC	digital selective calling
ECDIS	electronic chart display and information system
ELT	emergency locator transmitter
EPIRB	emergency position-indicating radio beacon
ETA	estimated time of arrival
ETD	estimated time of departure
°F	degrees Fahrenheit
F/V	fishing vessel
FLIR	forward looking infrared (camera)
FM	frequency modulation
ft	feet
fw	weather correction factor
GHz	gigahertz
GMDSS	global maritime distress and safety system
GNSS	global navigation satellite system
GPS	global positioning system
GS	ground speed
gt	gross tonnage
HF	high frequency
IBRD	International 406 MHz Beacon Registration Database

ICAO	International Civil Aviation Organization
ICS	International Chamber of Shipping
IFR	instrument flight rules
IMC	instrument meteorological conditions
IMO	International Maritime Organization
IMSO	International Mobile Satellite Organization
Inmarsat	an IMO recognized mobile satellite communication service provider for the GMDSS
INTERCO	International Code of Signals
ITU	International Telecommunication Union
JRCC	joint (aeronautical and maritime) rescue coordination centre
kg	kilogram
kHz	kilohertz
km	kilometres
kt(s)	knot(s) (nautical mile(s) per hour)
LCB	line of constant bearing
LES	land earth station
LKP	last known position
LRIT	long-range identification and tracking
LUT	local user terminal
LW	leeway
m	metre
M/V	merchant vessel
MCC	mission control centre
MEDEVAC	medical evacuation
MEDICO	medical advice, usually by radio
MF	medium frequency
MHz	megahertz
MMSI	maritime mobile service identity
MOB	man overboard
MRCC	maritime rescue coordination centre
MRO	mass rescue operations
MRSC	maritime rescue sub-centre
MSI	maritime safety information
MTTSI	minimum time-to-scene intercept
NBDP	narrow-band direct printing
NM	nautical mile
OS	contour search
OSC	on-scene coordinator
PANS-ATM	(ICAO) Procedures for Navigation Services – Air Traffic Management
PIF	pilot information file
PIW	person in water
PLB	personal locator beacon
POB	persons on board
POC	probability of containment (within the search area)
POD	(search) probability of detection
POS	(search) probability of success
PS	parallel track search
R	search radius
R/T	radio telephony
RANP	regional air navigation plan
RCC	rescue coordination centre
RPA	remotely piloted aircraft

RPAS	remotely piloted aircraft system
RSC	rescue sub-centre
RTF	radio telephony
RTT	radio teletype
S	track spacing
S/V	sailing vessel
SAC	special access code
SAR	search and rescue
SART	search and rescue radar transponder
SC	search and rescue coordinator
SES	ship earth station
SITREP	situation report
SLDMB	self-locating datum marker buoy
SMC	search and rescue mission coordinator
SMCP	(IMO) Standard Marine Communication Phrases
SOLAS	(IMO) Safety of Life at Sea Convention (also, compliant therewith)
SPOC	search and rescue point of contact
SRR	search and rescue region
SRS	search and rescue sub-region
SRU	search and rescue unit
SS	expanding square search
SSB	single-sideband
SU	search unit
SURPIC	surface picture
T	search time available
T	true course
TAS	true air speed
TCAS	traffic collision avoidance system
TMAS	telemedical assistance (or advice) service
TS	track line search
TSN	track line search, non-return
TSR	track line search, return
TTT	(aircraft) time-to-turn
UHF	ultra high frequency
UTC	coordinated universal time
V	(SAR facility) ground speed
VFR	visual flight rules
VHF	very high frequency
VMC	visual meteorological conditions
VS	sector search
W	sweep width
WT	radio telegraph
WWNWS	world-wide navigational warning service
Z	time zone identifier: UTC

Glossary [add:]

IMO recognized mobile satellite service: distress and safety communication service provided by a mobile satellite service recognized by the International Maritime Organization (IMO), for use in the GMDSS.

Mobile-satellite service: a radiocommunication service between mobile earth stations and one or more space stations, or between space stations used by this service; or between mobile earth stations by means of one or more space stations.

Triage: the process of sorting survivors according to medical condition and assigning them priorities for emergency care, treatment and evacuation.

Section 1 Overview of the SAR system

Section contents

Purpose

Responsibilities and obligations to assist

SAR coordination

 On-scene coordinator

 SAR mission coordinator

 SAR coordinator

National and regional SAR system organization

Coordination by land-based authorities

Ship reporting systems and vessel tracking

 Amver

Aircraft reporting system

Other assistance

Purpose

The purpose of the *International Aeronautical and Maritime Search and Rescue Manual for Mobile Facilities*, which is intended for carriage on board search and rescue units, and on board civil aircraft and vessels, is to provide guidance to those who:

- operate aircraft, vessels or other craft, and who may be called upon to use the facility to support SAR operations
- may need to perform on-scene coordinator functions for multiple facilities in the vicinity of a distress situation
- experience actual or potential emergencies, and may require search and rescue (SAR) assistance.

Responsibilities and obligations to assist

Under long-standing traditions of the sea and various provisions of international law, ship masters are obligated to assist others in distress at sea whenever they can safely do so.

The responsibilities to render assistance to a distressed vessel or aircraft are based on humanitarian considerations and established international practice. Specific obligations can be found in several conventions, including the following:

- Annex 12 to the Convention on International Civil Aviation
- International Convention on Maritime Search and Rescue
- Regulation V/33 of the International Convention for the Safety of Life at Sea, 1974 (SOLAS 1974). (See appendix A).

SAR coordination

The SAR system has three general levels of coordination:

- On-scene coordinators (OSCs)
- SAR mission coordinators (SMCs) (~~rescue coordination centre~~ based at Rescue Coordination Centres (RCCs))
- SAR coordinators (SCs) (national level).

On-scene coordinator

When two or more SAR facilities are working together on the same mission, one person on scene may be needed to coordinate the activities of all participating facilities.

- the SMC designates an OSC, who may be the person in charge of a:
 - search and rescue unit (SRU), ship, or aircraft participating in a search, or
 - nearby facility in a position to handle OSC duties
- the person in charge of the first facility to arrive at the scene will normally assume the OSC function until the SMC arranges for that person to be relieved.

SAR mission coordinator

Each SAR operation is carried out under the guidance of an SMC. This function exists only for the duration of a specific SAR incident and is normally performed by the RCC chief or a designee. The SMC may have assisting staff.

The SMC guides a SAR operation until a rescue has been effected or it becomes apparent that further efforts would be of no avail.

The SMC should be well trained in all SAR processes, be thoroughly familiar with the applicable SAR plans, and:

- gather information about distress situations
- develop accurate and workable SAR action plans
- dispatch and coordinate the resources to carry out SAR missions.

SMC duties include:

- obtain and evaluate all data on the emergency
- ascertain the type of emergency equipment carried by the missing or distressed craft
- remain informed of prevailing environmental conditions
- if necessary, ascertain movements and locations of vessels and alert shipping in likely search areas for rescue, lookout and/or radio watch
- plot the areas to search and decide on methods and facilities to be used
- develop the search action plan and rescue action plan as appropriate
- coordinate the operation with adjacent RCCs when appropriate
- arrange briefing and debriefing of SAR personnel
- evaluate all reports and modify action plans as necessary

- arrange for refuelling of aircraft and, for prolonged search, make arrangements for the accommodation of SAR personnel
- arrange for delivery of supplies to sustain survivors
- maintain in chronological order an accurate and up-to-date record
- issue progress reports
- determine when to suspend or terminate the search
- release SAR facilities when assistance is no longer required
- notify accident investigation authorities
- if applicable, notify the State of registry of the aircraft missing or distressed craft
- prepare a final report.

SAR coordinator

SCs are the top level SAR managers; each State normally will have one or more persons or agencies for whom this designation may be appropriate.

SCs have the overall responsibility for:

- establishing, staffing, equipping and managing the SAR system
- establishing RCCs and rescue sub-centres (RSCs)
- providing or arranging for SAR facilities
- coordinating SAR training
- developing SAR policies.

National and regional SAR system organization

Many States have accepted the obligation to provide aeronautical and maritime SAR coordination and services on a 24-hour basis for their territories, territorial seas, and where appropriate, the high seas.

- To carry out these responsibilities, States have established national SAR organizations, or joined one or more other States to form a regional SAR organization associated with an ocean area or continent.
- A search and rescue region (SRR) is an area of defined dimensions associated with a rescue coordination centre (RCC) an RCC, within which SAR services are provided.
 - SRRs help to define who has primary responsibility for coordinating responses to distress situations in every area of the world, but they are not intended to restrict anyone from assisting persons in distress
 - the International Civil Aviation Organization (ICAO) regional air navigation plans (RANPs) depict aeronautical SRRs

The International Maritime Organization (IMO) Global SAR Plan depicts maritime SRRs.

Coordination by land-based authorities

SAR operations are normally coordinated from specially equipped operational centres or RCCs, staffed 24 hours a day with trained personnel. The working language for these centres should be English.

Each RCC has an associated SRR. The SRR might be divided into sub-regions with associated ~~rescue sub-centres (RSCs)~~ RSCs.

- Land-based communication facilities include:
 - land earth stations (LESSs)
 - Cospas-Sarsat mission control centres with local user terminals (LUTs)
 - independent coast radio stations (CRSs) or CRSs associated with the RCCs
 - air traffic services (ATS) units
 - mobile phone networks
 - internet
 - public telephone alerting systems

Ship reporting systems and vessel tracking

Ship reporting systems have been established by several States.

Ships at sea may be the only craft near the scene of a distressed aircraft or vessel.

- A ship reporting system enables the SMC to quickly:
 - identify vessels in the vicinity of a distress situation, along with their positions, courses, and speeds
 - be aware of other information about the vessels which may be valuable (whether a doctor is on board, etc.)
 - know how to contact the vessels
 - improve the likelihood of rapid aid during emergencies
 - reduce the number of calls for assistance to vessels unfavourably located to respond
 - reduce the response time to provide assistance.
- Masters of vessels are urged or mandated to send regular reports to the authority operating a ship reporting system for SAR and other safety-related services.
- Additional information on operators of ship reporting systems may be obtained from RCCs.
- Automatic identification system (AIS) and long-range identification and tracking (LRIT) transmissions are also important for providing shore authorities with real or near real time vessel tracking data to support search and rescue.

Amver

- Amver is one of many ship reporting systems. It is a world-wide system operated exclusively to support SAR and make information available to all RCCs.
- There is no charge for vessels to participate in, nor for RCCs to use, Amver.
- Many land-based providers of communications services world-wide relay ship reports to Amver free of charge.
- Any merchant vessel of 1,000 gross tonnes or more on any voyage of greater than 24 hours is welcome to participate.

- Information voluntarily provided by vessels to Amver is protected by the US Coast Guard as commercial proprietary data and made available only to SAR authorities or others specifically authorized by the ship involved.

Aircraft reporting system

- Aircraft typically rely upon ~~air traffic services (ATS)~~ ATS units for flight following and communications services.
- Pilots are encouraged to file flight plans with the appropriate ATS unit to ensure expeditious response to an emergency.

Other assistance

SAR facilities may be required to perform operations other than search and rescue, which if not carried out could result in a SAR incident.

- assist a craft that is in a serious or potentially serious situation and in danger of becoming a SAR incident, such as a:
 - collision at sea
 - loss of propulsion
 - fire
 - grounding
 - vessel taking on water
 - insufficient remaining fuel.
- provide medical assistance.
- alert appropriate authorities of unlawful acts being committed against an aircraft or vessel:
 - pirate attack
 - hijacking attempt.
- assist after the vessel or aircraft has been abandoned, to minimize future hazards or to prevent future, unnecessary reports or reactions.

Section 2 Distress alerts and messages

Section contents

General advice

Distress signals

 Spoken emergency signals and procedural words

 EPIRBs, ELTs and PLBs

 121.5 MHz distress beacon alerts

 Additional equipment

Distress alert from a vessel

 Vessel distress message

 Visual distress signals

Distress alert from an aircraft

 Aircraft distress message

 Aircraft pilot distress message checklist

 Transmission of the distress message

Cancellation of distress message

Vessel and aircraft actions on observing AIS-SART or AIS-MOB device signals

General advice

Pilots-in-command and masters should not delay notifying the SAR system if a problem is, or may be, developing which could involve need for assistance. This allows the SAR system to carry out preliminary and contingency planning that could make the critical difference if the situation worsens.

~~Distress alert notification~~

~~Distress signals~~

Spoken emergency signals and procedural words

Three ~~spoken~~ emergency signals are used by aircraft and vessels:

Distress signal

- **MAYDAY** is used to indicate that a mobile craft or person is in threatened with grave and imminent danger and requests immediate assistance; for example, when a vessel has a man overboard situation and a master considers that further help is necessary
- has priority over all other communications

Urgency signal

- **PAN-PAN** is used when the safety of a mobile craft is in jeopardy
- the urgency signal PAN-PAN should be used when an unsafe situation exists that may eventually involve a need for assistance
- has priority over all but distress traffic

Safety signal

- **SÉCURITÉ** (pronounced SE-CURE-E-TAY) is used for messages concerning safety of navigation or giving important meteorological warnings

Any message headed by one of these signals has precedence over routine messages.

- The signal is usually repeated three times at the beginning of the message

A pilot-in-command or a master in a distress situation should declare a distress condition using the MAYDAY signal.

Basic spoken radio procedural words which SAR personnel should understand and use are as follows:

- **AFFIRMATIVE / AFFIRM** means that what a person has transmitted is correct
- **BREAK** is used to separate portions of a message or one message from another
- **FIGURES** is spoken just before numbers are given in a message
- **I SPELL** is used just before a phonetic spelling, such as of a proper name
- **NEGATIVE** means "no"
- **OUT** indicates the end of a transmission when no reply is expected or required
- **OVER** indicates the end of a transmission when an immediate reply is expected
- **ROGER** means "I have received your transmission satisfactorily"
- **SILENCE** (pronounced SEE LONSS) is said three times and means "cease all transmissions immediately"
- **SILENCE FINI** (pronounced SEE LONSS FEE NEE) means "silence is lifted", and is used to signify the end of the emergency and resumption of normal traffic
- **THIS IS** said before the station name or call sign which immediately follows
- **WAIT / STAND BY** means "I must pause for a few seconds; stand by for further transmission"

For a more detailed listing of procedural words to use, refer to the International Code of Signals (**INTERCO**).

EPIRBs, ELTs and personal locator beacons (PLBs)

- **EPIRB**: an EPIRB transmits a signal that alerts SAR authorities and allows rescue facilities to home in on the distressed vessel. It is activated automatically upon exposure to the sea, or manually. 406 MHz EPIRBs use Cospas-Sarsat satellites and are required on board certain vessels.
- **ELT**: most civil aircraft carry one of two types of ELT to alert SAR authorities to a distress situation.
 - 406 MHz ELT for use with Cospas-Sarsat satellites, required on aircraft on international flights
 - 121.5 MHz ELT might be allowed/required on domestic flights and is intended to be heard by other aircraft
- **PLB**: the 406 MHz PLB is not a mandated international carriage requirement, but may be carried on a person and has similar characteristics to EPIRBs and ELTs.

Cospas–Sarsat calculates position information for the 406 MHz distress beacons.

- Most ELTs and EPIRBs and PLBs provide homing signals on 121.5 MHz; some also use 243 MHz and some EPIRBs may also integrate SARTs into their designs.
- Most EPIRBs and all fixed ELTs are designed to activate automatically when a vessel sinks or an aircraft crashes. (EPIRB alerts tell whether the beacon was activated automatically or manually).
- Some ELTs and EPIRBs and PLBs may also have integral GPS capabilities.
- The followings steps should be followed when a distress beacon is inadvertently activated:
 - switch the distress beacon OFF; and
 - immediately attempt to notify the an RCC that the alert is false.

In cases where the beacon cannot be turned OFF, take measures to prevent or inhibit transmission of signal (e.g. shielding of transmission, battery removal, etc.). Such actions may prevent future use of the distress beacon.

Note: there is no penalty for inadvertent activation of a distress beacon.

121.5 MHz distress beacon alerts

- 121.5 MHz distress beacons are still in use and send out distress alerts heard on the radio as a WOW WOW sound of two alternating tones.
- Aircraft in flight are the primary means of detecting these alerts. Pilots-in-command should advise ATS units when this distress alert is heard.
- When in flight and reporting an alert from a 121.5 MHz distress beacon, the pilot-in-command should expect the ATS unit to request the following information:
 - your aircraft altitude above ground level, where and when the signal was first heard
 - your aircraft altitude above ground level, where and when maximum signal was heard
 - your aircraft altitude above ground level, where and when signal faded or was lost.

Additional equipment

- SOLAS ship requirements include the following:
 - two-way VHF radio-telephone apparatus and survival craft radar transponders to be placed on each side of the vessel, in a position ready to be taken on board a survival craft, and one of the following:
 - a radar SART which, after being switched on manually and triggered by radar(s) in its vicinity, automatically sends out a series of pulses which are displayed on a radar screen as a series of elongated pips, similar to a radar responder beacon (racon) pip, or
 - an AIS search and rescue transmitter (AIS-SART) which, after being switched on manually, automatically sends updated position reports using a standard AIS class A/B position report. An AIS-SART has a built-in GNSS receiver.

Distress alert from a vessel

Use any of the Global Maritime Distress and Safety System (GMDSS) equipment to transmit a distress alert:

- Inmarsat distress call
- VHF channel 16 (156.8 MHz FM)
- DSC on (VHF/MF or HF)
- EPIRB
 - any distress transmissions on ~~the frequency~~ VHF channel 16 or 2182 kHz could be preceded by a digital selective call
 - in remote oceans areas, the distress call should also be transmitted on a ship-to-shore HF circuit to a CRS, especially when distress calls on 2182 kHz or channel 16 are not replied to by other stations

Should there be doubt concerning the reception of the distress message, it should also be transmitted on any frequency available on which attention might be attracted, such as an inter-ship frequency which may be in use in ~~the local area~~ areas.

Before changing frequency, however, adequate time should be allowed for reply.

In the event of failure of the ship's radio station, it may be possible to transmit a message using portable equipment, provided for use in survival craft.

Vessel distress message

Important components of the distress message include:

- ~~— identification of the vessel~~
- ~~— position~~
- ~~— nature of distress and kind of assistance required~~
- the distress signal "MAYDAY"
- the name of the vessel in distress
- the call sign or other identification
- the MMSI (if the initial alert has been sent by DSC)
- the position, given as latitude and longitude, or if this is not known or if time is insufficient, in relation to a known geographical location
- the nature of the distress
- the kind of assistance required
- any other useful information; for example:
 - weather in immediate vicinity, wind direction, sea and swell, visibility
 - time of abandoning ship
 - number of crew remaining on board (total/POB)
 - number and type of survival craft launched
 - emergency location aids in survival craft or in the sea
 - number of seriously injured.

Include as much of the above information as practical in the initial distress message.

The timing of subsequent transmissions will be governed by circumstances. In general, if time allows, a series of short messages will be preferable to one or two long ones.

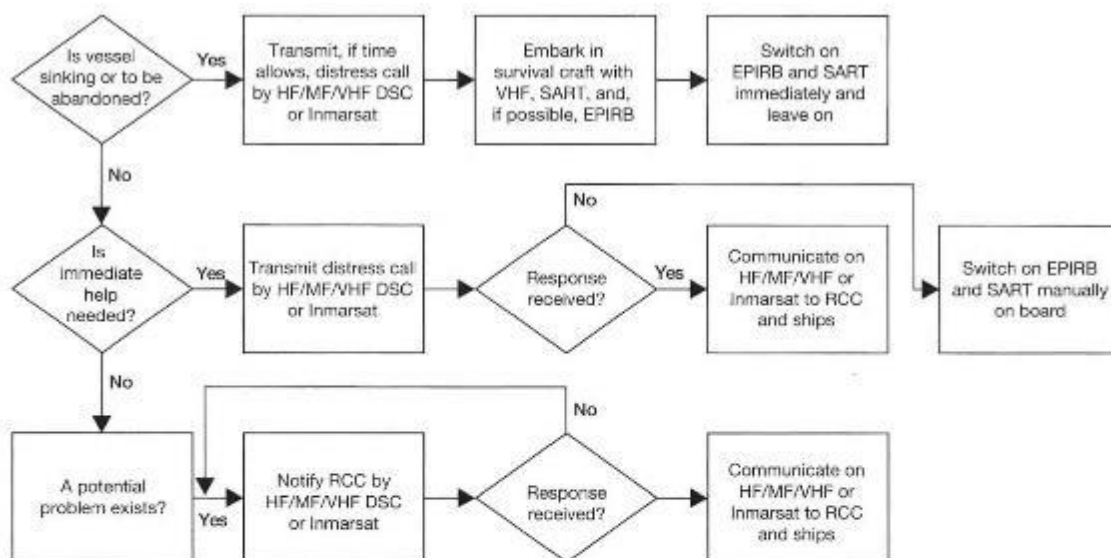

1. EPIRB should float free and activate automatically if it cannot be taken into survival craft
2. Where necessary, ships should use any appropriate means to alert other ships
3. Nothing above is intended to preclude the use of any and all available means of distress alerting

RADIO DISTRESS COMMUNICATIONS			
	Digital Selective Calling (DSC)	Radiotelephone	Radiotelex
VHF	Channel 70	Channel 16	
MF	2,187.5 kHz	2,182 kHz	2,174.5 kHz
HF4	4,207.5 kHz	4,125 kHz	4,177.5 kHz
HF6	6,312 kHz	6,215 kHz	6,268 kHz
HF8	8,414.5 kHz	8,291 kHz	8,376.5 kHz
HF12	12,577 kHz	12,290 kHz	12,520 kHz
HF16	16,604.5 kHz	16,420 kHz	16,695 kHz

GMDSS operating guidance for masters of ships in distress situation

Visual distress signals

Visual international distress signals are shown below. ~~Section 3 provides more information.~~

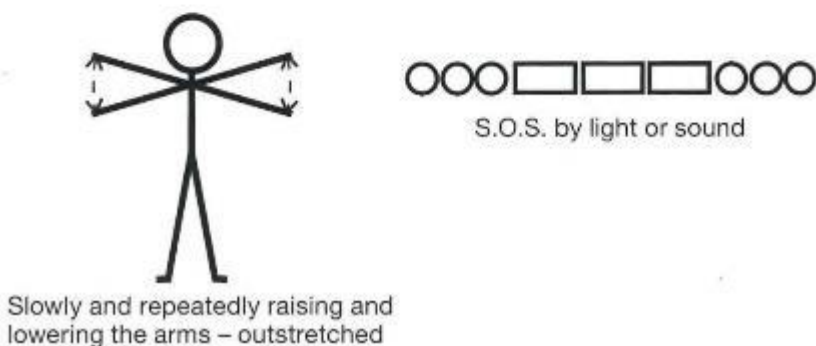
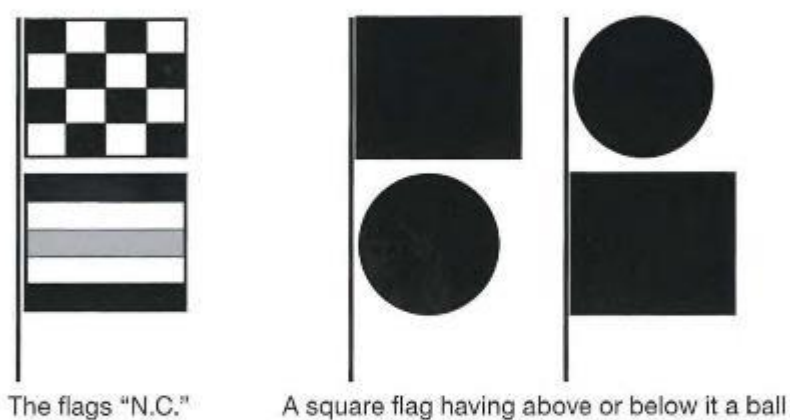
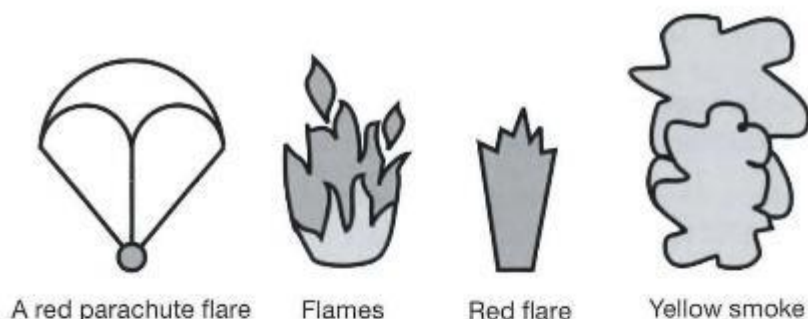

Distress alert from an aircraft

The aircraft would normally notify an ATS unit, which should notify the RCC.

Use 121.5 / 243.0 MHz if there is no response on the assigned en-route frequency and no data link communication is available:

- transmit blind
- set transponder to 7700 for distress
- set data link equipment to the appropriate emergency code, if so equipped
- an aircraft in distress may use any means at its disposal to attract attention, make known its position, and obtain help.

Aircraft distress message

An emergency can be either a DISTRESS or an URGENCY condition.

Distress

- Begin initial communication with the word "**MAYDAY**", repeated three times.

Urgency

- Begin initial communication with the word "**PAN-PAN**", repeated three times.

Specific procedures in handling emergency situations cannot be prescribed due to the variety of possible emergency situations.

- The flight operations manual for the specific type of aircraft is the best source of guidance and should be carried on board.

Aircraft pilot distress message checklist

When reporting an in-flight emergency, the pilot-in-command should expect the ATS unit to request the following information:

- aircraft identification and type
- nature of the emergency
- pilot's desires or intentions
- pilot should also include:
 - aircraft altitude
 - fuel remaining, in hours and minutes
 - pilot-reported weather
 - pilot capability for instrument flight rules (IFR) flight
 - time and place of last known position
 - heading since last known position
 - airspeed
 - navigation equipment capability
 - NAVAID signals received
 - visible landmarks
 - aircraft colour
 - number of persons on board
 - point of departure and destination
 - emergency equipment on board.

Transmission of the distress message

When an aircraft transmits a distress message by radio, the first transmission is generally made on the designated air-ground en-route frequency in use between the aircraft and an ATS unit.

- Although 121.5 MHz and 243.0 MHz are emergency frequencies, the aircraft will usually be kept on the initial contact frequency

- change frequencies only when there is a valid reason.
- In an emergency, the aircraft may use any other available frequency to establish contact with any land, mobile, or DF station.
- SAR organizations ordinarily will inform merchant ships of aircraft emergencies at sea.

Cancellation of distress message

- Cancellation should occur as soon as the distressed craft has been recovered or when the assistance of SAR facilities is no longer required.
- Any false alert, including by inadvertent human error, should be cancelled so that SAR authorities do not needlessly respond.

Vessel and aircraft actions on observing AIS-SART or AIS MOB device signals

Vessels at sea may observe AIS-SART or AIS MOB signals on navigation displays. Although AIS-SARTs and AIS MOB are locating signals, these signals may be related to a vessel or craft that has activated a device to draw attention to its location due to a distress situation and this should be investigated by RCCs. Therefore, AIS-SART and AIS MOB transmissions should not normally be ignored unless information is available that confirms that no response is necessary, e.g. it is known to be a false alarm.

The majority of vessels will have AIS directly linked to the electronic charting system which means that the SART should automatically be displayed on the navigation display. The AIS-SART and AIS MOB also display on any X band radar as a series of 12 dots for identification.

It is recommended that any vessel at sea or aircraft that observes AIS-SART or AIS MOB signals should report this to the nearest RCC immediately. The RCC will then take appropriate actions.

Vessels or aircraft should also be prepared to proceed to the location of the AIS-SART or AIS MOB signal, if it is safe to do so, to assist the RCC in investigating the transmission. As AIS-SART and AIS MOB signals are likely to transmit over relatively short distances, e.g. up to 10 NM, a vessel should not be significantly delayed by doing this.

Section 3 Medical assistance

Section contents

Medical emergencies

Medical assistance to vessels

Satellite communications

MEDICO

Medical evacuation (MEDEVAC)

 Evacuation by helicopter

Medical emergencies

- conduct assessment of victim for primary medical treatment
- attend to treatment as best as possible with on board facilities and medications
- see previous discussion on MEDICO and MEDEVAC below
- if medical evacuation is required, alert proper authorities
- prepare patient for evacuation
- gather appropriate paperwork and attach to patient.

Medical assistance to vessels

Medical assistance is available using telemedical assistance services (TMASs). A TMAS is a medical service permanently staffed by doctors experienced in conducting remote consultations and aware of the particular nature of treatment on board ship. The system provides for direct communication between ships and the TMAS.

The ship will normally contact the TMAS associated with the RCC within whose SAR region the ship is located.

Alternatively, the ship may contact another TMAS, usually to overcome language difficulties. All medical information collected by this TMAS should be transferred to the TMAS associated with the RCC responsible for coordinating any further action required, to avoid duplication.

Satellite communications

Inmarsat systems offer three special access codes (SACs) which can be used for medical advice or medical assistance at sea:

- SAC 32 is used to obtain medical advice. The land earth station will provide a link with the TMAS when this code is used.
- SAC 38 is used when the condition of an injured or sick person on board a ship justifies medical assistance (evacuation to shore or services of a doctor on board). This code allows the call to be routed to the associated RCC.
- SAC 39 is used for maritime assistance. This code allows the call to be routed to the associated RCC.

MEDICO

MEDICO messages request or transmit medical advice between vessels at sea and a TMAS.

Each MEDICO message may be addressed to RCCs or communications facilities from ships at sea.

The ITU List of Radiodetermination and Special Service Stations lists commercial and Government radio stations which provide free medical message service to ships.

- These messages are normally delivered only to TMASs, hospitals or other facilities with which SAR authorities or the communications facilities have made prior arrangements.

SAR services may also provide medical advice either from their own doctors or via arrangements with TMAS.

In addition to the many telemedical assistance services provided free of charge, there are several commercial enterprises which provide international subscriptions and pay-per-use medical advice to vessels at sea.

Vessels fitted with broadband services, Fleet Broadband (F77) and VSAT (very small aperture terminal) will permit the easy transfer of photographs and videos.

Replies to messages should indicate the medical facility which provided the medical information.

Medical evacuation (MEDEVAC)

If medical evacuations are being considered, the benefits must be weighed against the inherent dangers of such operations to both the person needing assistance and to the rescue personnel.

When medical assistance is required, information as indicated below should be sent to the RCC. Other information may be necessary in certain cases.

- name of the vessel, flag, IMO number, radio call sign and telephone number
- master's name and nationality
- shipowner / operator, nationality and contact details
- patient's name, age, gender, nationality, and language
- patient's respiration, pulse rate, temperature, and blood pressure
- location of pain
- nature of illness or injury, including apparent cause and related history
- symptoms
- type, time, form, and amounts of all medications given
- time of last food consumption
- ability of patient to eat, drink, walk, or be moved
- with accident cases, how the accident occurred
- whether the vessel has a medicine chest, and whether a physician or other medically trained person is on board
- whether a suitable clear area is available for helicopter winch operations or landings
- name, address and phone number of vessel's agent
- last port of call, next port of call, and ETA to next port of call

- communications and homing signal available
- additional pertinent remarks.

The final decision about whether it is safe to conduct an evacuation remains ultimately with the person in command of the rescue facility tasked with conducting the evacuation. The vessel's master is responsible for the safety of his vessel and personnel and may decide against the evacuation.

Evacuation by helicopter

When arranging for the evacuation of a patient by helicopter, the following points should be considered.

- requesting helicopter assistance
 - arrange a rendezvous position as soon as possible if the vessel is beyond helicopter range and must divert
 - give as much medical information as possible, particularly about the patient's mobility
 - advise immediately of any changes in the condition of the patient
- preparation of patient before the helicopter arrives
 - move the patient to the helicopter pick-up, if so required
 - ensure the patient is tagged to show details of any medication which has been administered
 - prepare the patient's seaman's papers, passport, medical record, and other necessary documents in a package ready for transfer with the patient
 - ensure that personnel are prepared as necessary to move the patient to the special stretcher (lowered by the helicopter) as quickly as possible
 - the patient should be strapped in the stretcher face-up, in a lifejacket if condition permits.

Section 4 Vessel emergencies at sea

Section contents

Man overboard

- Three situations

- Vessel manoeuvres

- Initial action

- Standard recovery manoeuvres

Shipboard fire

Grounding

Hull damages

Collision

Abandoning ship

Unlawful acts

- Pirates and armed robbers

- Pirates detected prior to boarding of the vessel

- Pirates board unnoticed

Man overboard

Three situations

Immediate action

- The person overboard is noticed from the bridge and action is taken immediately.

Delayed action

- The person is reported to the bridge by an eyewitness and action is initiated with some delay.

Person-missing action

- The person is reported to the bridge as missing.

Vessel manoeuvres

- When the possibility exists that a person has fallen overboard, the crew must attempt to recover the individual as soon as possible.
- Some factors that will affect the speed of recovery include:
 - ship's manoeuvring characteristics
 - wind direction and sea state
 - crew's experience and level of training
 - capability of the engine plant
 - location of the incident
 - visibility level
 - recovery technique
 - possibility of having other vessels assist.

Initial action

- Mark and note position and time from GNSS.
- Throw a life-ring over the side as close to the person as possible.
- Sound three prolonged blasts of ship's whistle; hail "man overboard".
- Commence recovery manoeuvre as indicated below.
- Note wind speed and direction.
- Inform master of vessel and engine-room.
- Post look-outs to keep the person in sight.
- Set off dye marker or smoke flare.
- Inform radio operator; keep updated on position.
- Stand by the engines.
- Prepare recovery equipment – see section 2, ~~Recovery of survivors by assisting vessels~~ 14.

- Distribute portable VHF radios for communication between bridge, deck, and lifeboat.

Standard recovery manoeuvres

- Williamson turn
 - makes good original track line
 - good in reduced visibility
 - simple
 - takes the ship farther away from the scene of the incident
 - slow procedure

Williamson turn procedure

- 1 Rudder hard over (in an "immediate action" situation, only to the side of the casualty).
- 2 After deviation from the original course by 60° , rudder hard over to the opposite side.
- 3 When heading 20° short of opposite course, rudder to midship position and ship to be turned to opposite course.

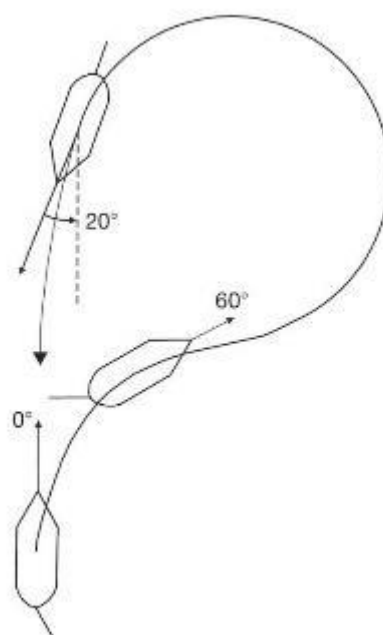

- One turn ("Single turn, Anderson turn")
 - fastest recovery method
 - good for ships with tight turning characteristics
 - used most by ships with considerable power
 - very difficult for a single-screw vessel
 - difficult because approach to person is not straight

Single turn (270° manoeuvre)

- 1 Rudder hard over (in an "immediate action" situation, only to the side of the casualty).
- 2 After deviation from the original course by 250°, rudder to midship position and stopping manoeuvre to be initiated.

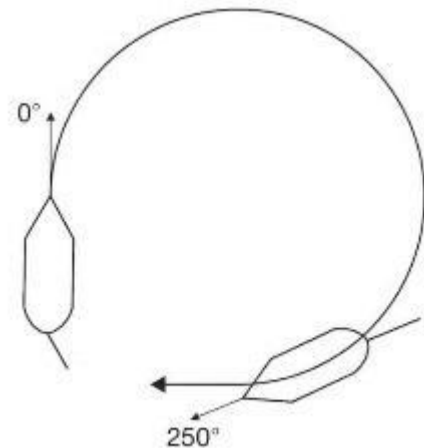

- Scharnov turn
 - will take vessel back into her wake
 - less distance is covered, saving time
 - cannot be carried out effectively unless the time elapsed between occurrence of the incident and the commencement of the manoeuvre is known

Scharnov turn procedure

- 1 Not to be used in an "immediate action" situation.
- 2 Rudder hard over.
- 3 After deviation from the original course by 240°, rudder hard over to the opposite side.
- 4 When heading 20° short of opposite course, rudder to midship position so that ship will turn to opposite course.

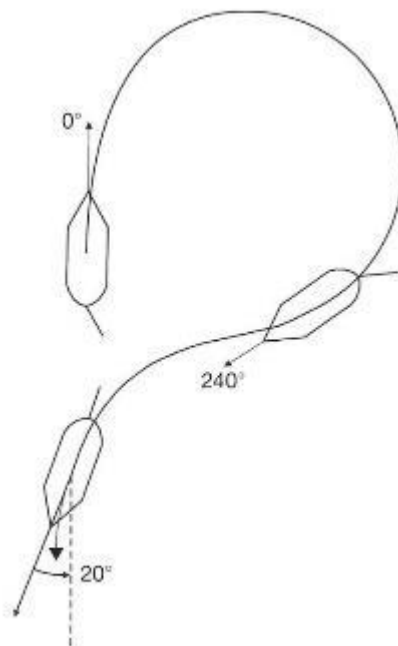

- **Lorén turn**
 - facilitates launch and recovery of a rescue boat
 - facilitates rescue work by other craft
 - circling calms the sea by interfering with wave patterns
 - the more turbulence created by the ship the better
 - additional ships circling to windward will calm the sea further

Lorén turn procedure

- 1 Head into the wind at full speed.
- 2 Begin the circle and reduce to slow when the wind is abeam.
- 3 When the wind crosses the stern to the opposite quarter, increase to half speed.
- 4 Continue circling as long as calmer water is needed.
- 5 Slow down, or stop, to launch and recover rescue boat on the leeward side, inside the circle.

Note: It is important to know the handling characteristics of your own vessel. Opportunities should be taken to practice these manoeuvres. Depending on the ship's handling criteria it may not be necessary to begin the Lorén turn head-to-wind.

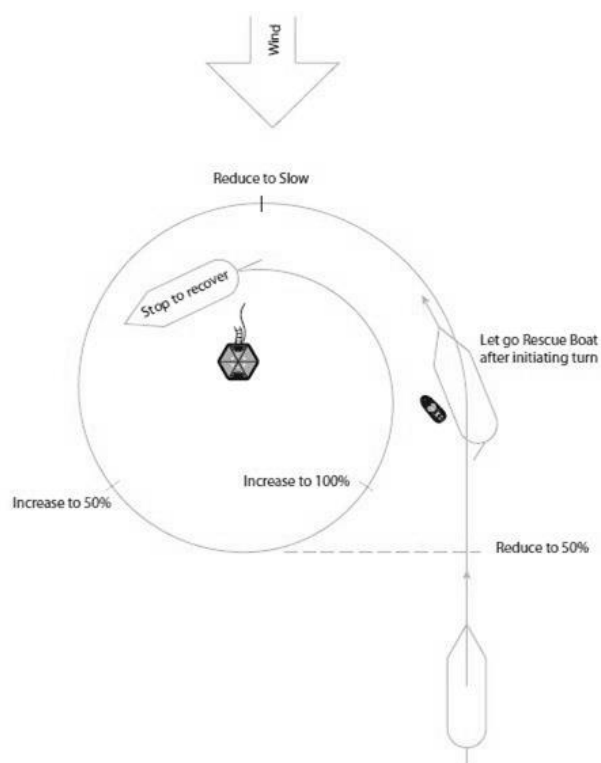

Ship emergencies at sea

Some emergencies at sea consist of:

Shipboard fire

- sound fire alarm
- report location of fire
- assess fire
 - determine the class of fire
 - determine appropriate extinguishing agent
 - determine appropriate method of attack
 - determine how to prevent the spread of the fire
 - determine the required personnel and fire-fighting assignments
 - establish proper communications between bridge and location of fire
 - begin procedures for attacking the fire
 - continue until fire is extinguished
 - if assistance is required, transmit distress call and message

Grounding

- check for hull damages
- if assistance is required, transmit a **distress or a PAN-PAN** urgency signal **message as appropriate**
- determine which way deep water lies
- determine if wind and sea are carrying the vessel harder aground
- lessen the draught of the vessel
- put engines astern to back away
- if extrication is impossible until assistance arrives or change of tide, minimize hull damage and water intake

Hull damages

- identify location of incoming water
- cut off all electrical power running through area
- shore up area to stem water flow
- check bilge pump for operation
- check auxiliary pumps for back-up operation if needed
- ~~— if necessary, abandon vessel as a last resort~~

Collision

- establish communication with the other vessel
- evaluate the situation (including, but not limited to, hull damage, injured persons, etc.)
- if assistance is required, transmit distress or urgency message
- inform RCC
- ~~— abandon vessel as a last resort.~~

Abandoning ship

- abandon ship only as last resort
- transmit distress call and message
- wear adequate clothing and, if available, immersion suits
- wear lifejackets, tightly fastened
- take anti-seasickness medication
- have crew members stand by lifeboat or liferaft and prepare to launch
- make sure sea painter is attached to vessel
- take SART, AIS-SART and/or EPIRB with you, if possible
- load crew and launch
- keep lifeboat or liferaft tethered to vessel as long as possible

Unlawful acts

Pirates and armed robbers

- There is a special signal for use by a vessel under attack or threat of attack from pirates or armed robbers.
- "Piracy/armed robbery attack" is a category of distress message for all classes of DSC equipment and Inmarsat has added a piracy message to the Inmarsat-C menu for the GMDSS.
 - for their own safety, vessels may have to covertly send out a "piracy/ armed robbery attack" message.
- When the RCC becomes aware of such a situation, it will advise appropriate agencies.
- If the vessel covertly sends a message, care will be taken regarding any communications sent back to the vessel so as not to warn the pirates.
- The two distinct phases to an attack by pirates or armed robbers are:
 - pirates are detected by shipboard personnel prior to boarding of the vessel
 - pirates board unnoticed, taking hostages and making threats of violence or death to the vessel's crew.
- Pirates normally order the vessel not to make any radio transmissions, with further threats of violence.

Pirates detected prior to boarding of the vessel

- Providing the vessel has not been ordered by the pirates to maintain radio silence, contact should immediately be made with vessels in the vicinity and shore authorities by sending a "piracy/armed robbery attack" message through Inmarsat or on an available DSC or other distress and safety frequency.

Pirates board unnoticed

- A vessel should comply with any order by pirates or armed robbers not to make any form of transmission informing shore authorities of the attack. Pirates may carry equipment capable of detecting terrestrial radio signals.
 - a recommended alternative in this scenario is for the alarm signal to be automatically made through satellite so as not to be detected by the pirates
 - the alarm signal should be made through Inmarsat by using the Inmarsat-C "piracy/armed robbery attack" message along with the vessel's current position.
- This message should be activated by means of concealed push buttons located in at least three separate locations on the vessel
 - wheelhouse
 - master's cabin
 - engine room.
- Activation of the push button should result in the satellite terminal automatically selecting and transmitting the attack message to the appropriate shore authority.

- To avoid false alerts there should be a coded sequence of operation of the push button which will require deliberate action to activate it. This system will:
 - leave the pirates unaware that a message has been transmitted
 - provide early warning to shore authorities that an attack is in progress and may deter future attacks.

Section 5 – Aircraft emergencies

Section contents

Aircraft emergencies

Emergency equipment

In-flight emergencies general information

Unlawful interference

Low on fuel

Mechanical difficulties

Loss of communications

Forced landing

Aircraft ditching

Surface craft assistance

Aircraft emergencies

- For in-flight emergencies, follow the guidance provided in the flight operations manual for the particular aircraft being flown. If that manual is not available, the following general information should be helpful.

Emergency equipment

- No person should operate an aircraft in extended overwater operations without having the equipment listed below on the aircraft:
 - a life preserver (lifejacket) equipped with locator light and whistle for every person on board
 - enough liferafts to accommodate all of the occupants
 - at least one pyrotechnic signal device for each liferaft
 - a survival type ELT, with extra batteries
 - survival and first-aid kit attached to each required liferaft
 - an immersion suit if warranted, and if the aircraft is suitable for wearing it.
- All must be easily accessible in the event of a ditching.
- The equipment should be in conspicuously marked locations.

In-flight emergencies – general information

~~Some in-flight emergencies consist of:~~

Unlawful interference

- If able, set transponder to 7500 for unlawful interference.

Low on fuel

- Establish the most economical airspeed; if the engine(s) fail, maintain the best glide airspeed

- Communicate the situation, position, and intentions to the appropriate ATS unit, using 121.5 MHz if no other frequency is available.
- It is safer to land or ditch under power and before fuel is exhausted.

Mechanical difficulties

- If able, communicate the situation, position, and intentions to the appropriate ATS unit, using 121.5 MHz if no other frequency is available.
- Land as soon as practical.

Loss of communications

- Set the transponder to 7600 for communications failure.
- Use visual signals in section 2-8, under Search function-"Visual communications".

Forced landing

- Set the transponder to 7700 for distress.
- Notify ATS of situation, position, and intentions.
- Choose a suitable landing spot.
- Ensure that seat belts and harnesses are properly secured.

With power:

- overfly the intended landing site at low speed and altitude, looking for obstructions and verifying wind direction
- climb to a normal pattern altitude
- make a normal approach, using full flaps and landing techniques for short or soft fields
- have passengers brace for impact
- keep the landing gear up for rough fields and water landings
- switch fuel and electrical power off when landing is assured
- evacuate the aircraft immediately and remain clear until danger of fire has passed
- administer first aid to injured crew and passengers as needed
- manually activate the ELT.

Without power:

- make a normal approach, using full flaps and landing techniques for short or soft fields
- have passengers brace for impact
- keep the landing gear up for rough fields and water landings
- switch fuel and electrical power off once the flaps and gear (if applicable) are down

- evacuate the aircraft immediately and remain clear until danger of fire has passed
- administer first aid to injured crew and passengers as needed
- manually activate the ELT.

Aircraft ditching

- Set the transponder to 7700 for distress.
- Notify ATS of situation, position, and ditching intentions
 - normally this will be done on the en-route air traffic control frequency or 121.5/243.0 MHz
 - if two-way communications are not established, transmit in the blind
 - if the aircraft is equipped with HF radio, ask ATS to have SAR authorities alert ships in the vicinity and have those ships attempt communications with the aircraft on 4125 kHz.
- If bailing out is an option, determine whether this would be safer than ditching.
 - military fighter aircraft, due to their high landing speed and small size, often react violently to ditching
 - military bombers, because of their relatively weak bottom due to large bomb-bay doors, can break apart under the forces encountered in ditching
 - for both of these aircraft types, it usually is better to bail out rather than ditch
 - most other types of aircraft have been ditched successfully
 - ditching performance is best in pressurized, low-wing aircraft without large underslung engine nacelles or long afterbodies.
- Determine the primary and secondary swell directions.
 - primary swell will be visible during day visual meteorological conditions (VMC) from an altitude of 2,000 ft or higher
 - swells are generated by distant weather systems and do not break
 - the primary swell system will appear as a definite pattern or differences in light intensity on the surface
 - watch the pattern for a few moments; the direction of motion can be determined
 - at night or under IMC, this information may be available from surface ships ~~craft~~ in the area
 - the secondary swell system, if present, may not be visible until the altitude is between 1,500 and 800 ft.
- Determine surface wind direction and speed.
 - examine local wind effects on the water
 - whitecaps fall forward with the wind, but are overrun by waves, thus producing the illusion that the foam is sliding backward. Plan to land in the same direction that the whitecaps are moving unless the swells are large

- wind velocity can be accurately estimated by noting the appearance of the whitecaps, foam, and wind streaks
- the Beaufort scale is provided at the end of this discussion for wind velocity and wave heights.
- Verify wind and swell analysis.
 - when flying at low altitude above the water the seas will appear to be steep, fast, and rough when heading into them
 - when flying down or parallel to the seas, the surface appears to be more calm.
- Jettison cargo and fuel, but retain sufficient fuel for landing under power.
- Ensure that seat belts and harnesses are properly secured.
- Determine the best heading for ditching.
 - The figure below shows a landing parallel with the swell. This is the best ditching heading; landing on the top or back side of the swell is preferable.

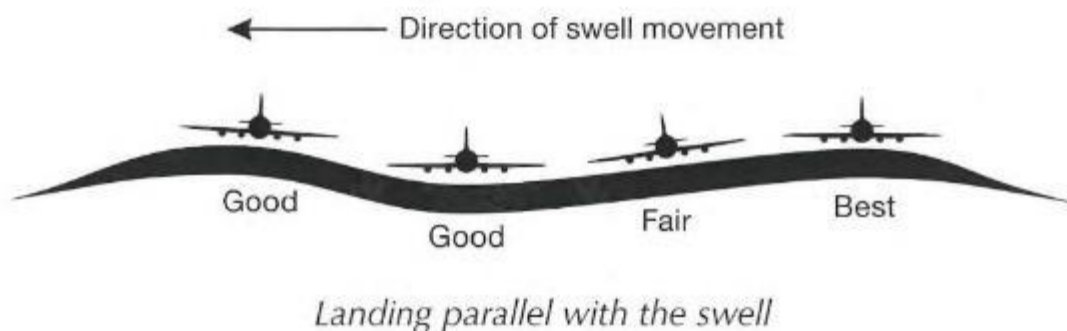

- the best ditching heading usually is parallel to the primary swell system and down the secondary swell system
- the next best choice is parallel to the secondary swell system and down the primary swell system
- the choice between these two options is determined by which will give the greatest headwind component
- try to land with the wind on the opposite side to the passenger door; this more-sheltered side may make opening the door and subsequent exit by passengers easier.
- Never land into the face (or within 35° of the face) of a primary swell unless the surface winds are an appreciable percentage of the aircraft stalling speed in the ditching configuration.

Winds 0–25 knots

- ignore the crosswind component and land parallel to the primary swell, using the heading that has the greatest headwind component

- if a pronounced secondary swell exists, it may be desirable to land down the secondary system and accept some tailwind component

Winds above 25 knots

- it may be necessary to select a heading neither parallel to the swell (since the crosswind component may make for unacceptable control at slow airspeeds) nor into the wind (because the ground- speed reduction due to the headwind will not compensate for the disadvantage of landing into the swell)
- a heading at an angle into the wind and primary swell is indicated, with more of a crosswind component accepted the higher the swells and more of a headwind component taken the higher the winds with respect to the aircraft stalling speed
- when landing parallel to a swell system, it is best to land on the crest; it is acceptable to land on the backside or in the trough
- landing on the face of the swell should be avoided
- if forced to land into a swell, touchdown should be just after passage of the crest.

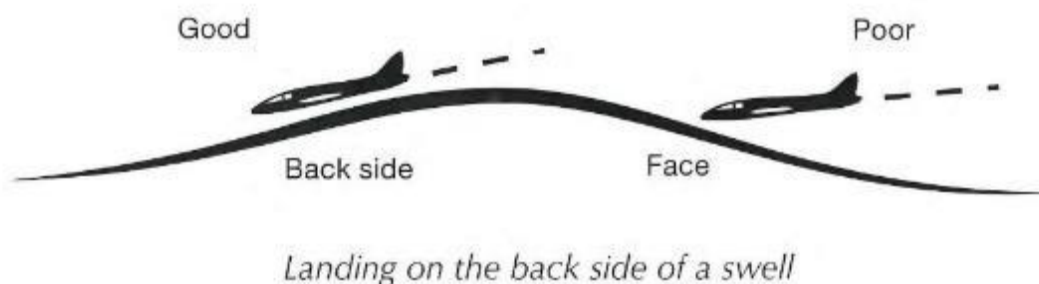

- Turn to the ditching heading and begin letdown.
 - flaps should be fully extended
 - the landing gear should be left retracted.
- When at a low altitude, slow to touchdown speed, 5 to 10 knots above the stall.
- Use power to maintain a minimal (no more than 300 feet per minute) rate of descent and approximate 10° nose-up attitude.
 - the kinetic energy to be dissipated, and resulting deceleration, increase with the SQUARE of the velocity at touchdown
 - when over smooth water or at night it is very easy to misjudge the height over the water. This technique minimizes the chance of misjudging the altitude, stalling the aircraft, and entering the water in a disastrous nose-down attitude
 - the proper use of power on the approach is extremely important
 - if power is available on one side only, a little power should be used to flatten the approach; a balance will need to be achieved between the need to impact the water

as slowly as possible and the loss of control that can occur with sudden application of unbalanced power at an airspeed near the stall.

- Pick a touchdown spot
 - the pilot should observe the sea surface ahead
 - shadows and whitecaps close together indicate that the seas are short and rough
 - touchdown in those areas should be avoided
 - touchdown should be in an area (only about 150 m is needed) where the shadows and whitecaps are not so numerous.
- Cut the power and brace for impact.
 - maintain airspeed at 5 to 10 knots above the stall; do NOT let the aircraft stall; do not flare the landing
 - if necessary to keep the proper nose-up attitude, keep power until the tail touches the surface
 - keep the wings level.
- Evacuate the aircraft as rapidly as possible after all motion has stopped
 - passengers should remain strapped into their seats until the inrush of water, if any, has subsided, in order to avoid being swept around the cabin
 - helicopters are prone to roll inverted except in very calm water, even if equipped with flotation devices
 - in order to avoid disorientation, occupants should identify and hold onto a reference until ready to exit the aircraft
 - lifejackets must not be inflated until clear of the aircraft.

Beaufort scale

Beaufort number	Wind velocity (knots)	Sea indications	Height of waves	
			metres	feet
0		Like a mirror.	0	0
1	1-3	Ripples with the appearance of scales.	0.2	0.5
2	4-6	Small wavelets; crests have a glassy appearance and do not break.	0.3	1
3	7-10	Large wavelets; crests begin to break. Foam of glassy appearance; few very scattered whitecaps.	1	2
4	11-16	Small waves, becoming larger. Fairly frequent whitecaps.	2	5
5	17-21	Moderate waves, taking a pronounced long form; many whitecaps.	3	10
6	22-27	Large waves begin to form; white foam crests are more extensive; some spray.	5	15
7	28-33	Sea heaps up and white foam from breaking waves begins to be blown in streaks along the direction of waves.	6	20
8	34-40	Moderately high waves of greater length; edges of crests break into spindrift; foam blown in well-marked streaks in the direction of the wind.	8	25
9	41-47	High waves. Dense streaks of foam; sea begins to roll; spray affects visibility.	9	30
10	48-55	Very high waves with overhanging crests; foam in great patches blown in dense white streaks. Whole surface of sea takes on white appearance. Visibility is affected.	10	35

Aircraft ditching guidance

Aircraft emergency procedures for ditching are provided in section 4.

Surface craft assistance

If an aircraft has to ditch, or the crew bail out over water, the most advantageous place is near a surface craft, preferably alongside and slightly ahead. Further discussion is provided within the maritime portion of this section.

Assistance from ships

Assistance that might be provided in a ditching situation includes:

- Establishing and maintaining communications with the aircraft. See section 8.
 - every effort should be made to establish direct voice communication between the ship and distressed aircraft
 - a lost-contact procedure should be arranged in the event that contact is lost
- Locating the aircraft. The ship may locate the aircraft by:

Radar

- standard procedure is for the distressed aircraft to put its transponder on Code 7700 (~~Useful for appropriately equipped vessels.~~)
- ~~if this is not possible~~, the pilot may be able to make a 90° identification turn
- the pilot should hold the new course for three minutes and then return to base course

Homing signals

- if the ship can send homing signals on a frequency compatible with the aircraft's automatic direction finder, the pilot may be able to provide a reciprocal bearing

Shore-based assistance

- authorities may be able to provide a position on the aircraft from DF stations or other available information

Aircraft's navigational data

- the pilot may be able to give a position from navigational data

Weather data

- unusual weather conditions reported by the pilot may give clues about the aircraft's position.
- Vectoring or assisting in homing the aircraft to the ship.
 - a ship may assist an aircraft by providing a homing signal or course to steer based on radar or DF bearings from the ship
 - during daylight, a ship may make black smoke, cruise at high speeds to form a wake, or use other means to attract attention visually
 - at night, star shells, searchlights, pyrotechnics, deck lights, or water lights may be used.
- Providing weather, sea information, and recommended ditching heading.
- Final determination of the ditching heading is the responsibility of the pilot, who should inform the ship of the selected ditching heading as soon as possible.
- Marking the sea lane along the selected ditching heading.
 - during daylight, with relatively calm sea conditions, a ship may mark the sea lane with fire-extinguisher foam
 - at night, or during a low-visibility daytime ditching, a ship may lay a series of floating lights along the selected ditching heading.

- Providing approach assistance.
 - approach may be made visually, by DF using the homing signals from the ship, by radar assistance from the ship, or by a combination of these
 - the ship will normally be to one side of the sea lane
 - under visual conditions, day or night, the aircraft should make a visual approach
 - during low ceiling or poor visibility, a ship may provide continuous homing signals through the final approach
 - it may also operate air navigation aids to allow an instrument approach
 - the pilot should be aware of the height of the masts on the ship and must allow some deviation on final approach in order not to collide with the ship
 - if the pilot desires, and radar contact is held by the ship, it may give radar ranges
 - full radar-controlled approach should not be attempted unless the ship is qualified in such approaches.
- Providing illumination.
 - ships with flare or star-shell capability can provide illumination at night for a visual approach
 - illumination may be placed over the ditching location and over-shoot area, approximately 1,200 m (3,600 ft) past the end of the sea lane
 - the ship may also fire an orientation flare when the pilot begins the approach.

Assistance to ditching aircraft

Aircraft usually sink quickly, within minutes. Vessels will often be the rescue facility.

- When an aircraft decides to ditch in the vicinity of a ship, the ship should:
 - transmit homing bearings to the aircraft
 - transmit signals enabling the aircraft to take its own bearings
 - by day, make black smoke
 - by night, direct a searchlight vertically and turn on all deck lights (care must be taken NOT to direct a searchlight towards the aircraft which may adversely affect the pilot's vision).
- A ship which knows that an aircraft intends to ditch should prepare to give the pilot the following information:
 - wind direction and force,
 - direction, height, and length of primary and secondary swell systems,

- current state of the sea,
- current state of the weather.
- The pilot of an aircraft will choose his own ditching heading.
- If this is known by the ship, it should set course parallel to the ditching heading.
- Otherwise, the ship should set course parallel to the main swell system and into the wind component as shown in the figure below:

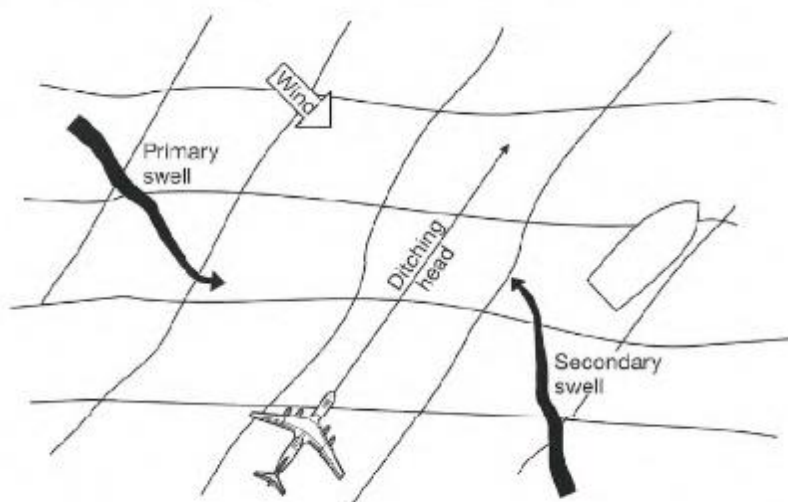

~~Rescue and care of survivors.~~

- Rescue may be by small boats or the ship itself. See section 14.
- Survivors in the water or aircraft should usually be rescued first and those safe in rafts last.
- If there are serious injuries, the SMC can make medical arrangements. See section 3.

Section 6 – Initial action by assisting vessels

Section contents

Methods of distress notification

Immediate action

Proceeding to the area of distress

On-board preparation

 Life-saving and rescue equipment

 Signalling equipment

 Preparations for medical assistance

 Miscellaneous equipment

Vessels not assisting

Vessels assisting

Methods of distress notification

- A distress call or signal or other emergency information from another vessel at sea, either directly or by relay.
- A distress call or message from aircraft. This will normally occur by relay from an aircraft, RCC or CRS.

Immediate action

- The following immediate action should be taken by any ship receiving a distress message:
 - acknowledge receipt of message (for DSC acknowledgement see flow charts)

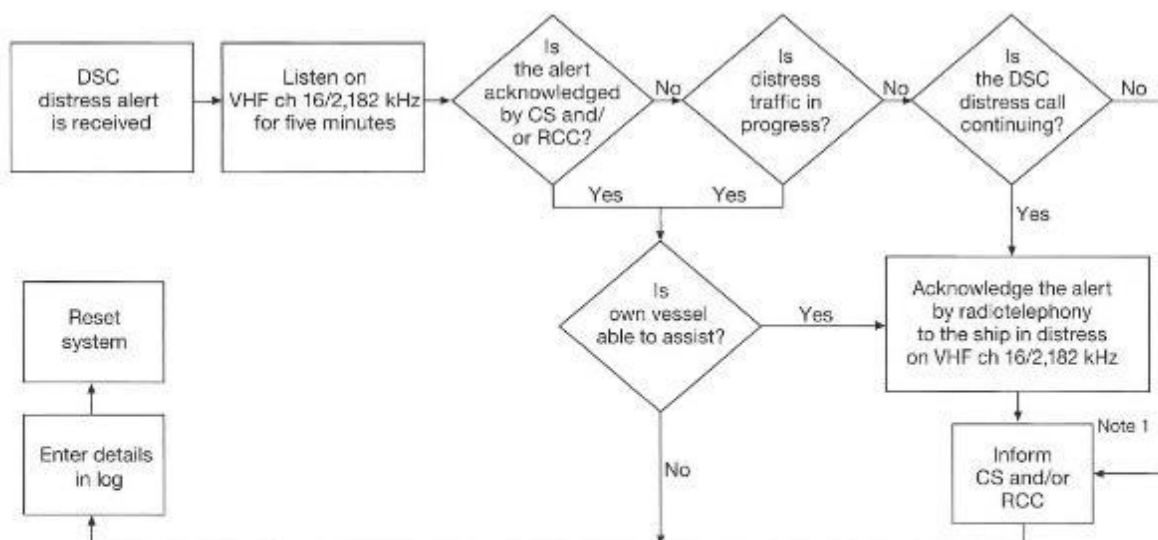

Remarks

Note 1: Appropriate or relevant RCC and/or Coast Station shall be informed accordingly. If further DSC alerts are received from the same source and the ship in distress is beyond doubt in the vicinity, a DSC acknowledgement may, after consultation with an RCC or coast station, be sent to terminate the call.

Note 2: In no case is a ship permitted to transmit a DSC distress relay call on receipt of a DSC distress alert on either VHF channel 70 or MF channel 2,187.5 kHz.

CS = coast station RCC = rescue co-ordination centre

Actions by ships upon receipt of VHF/MF DSC distress alert

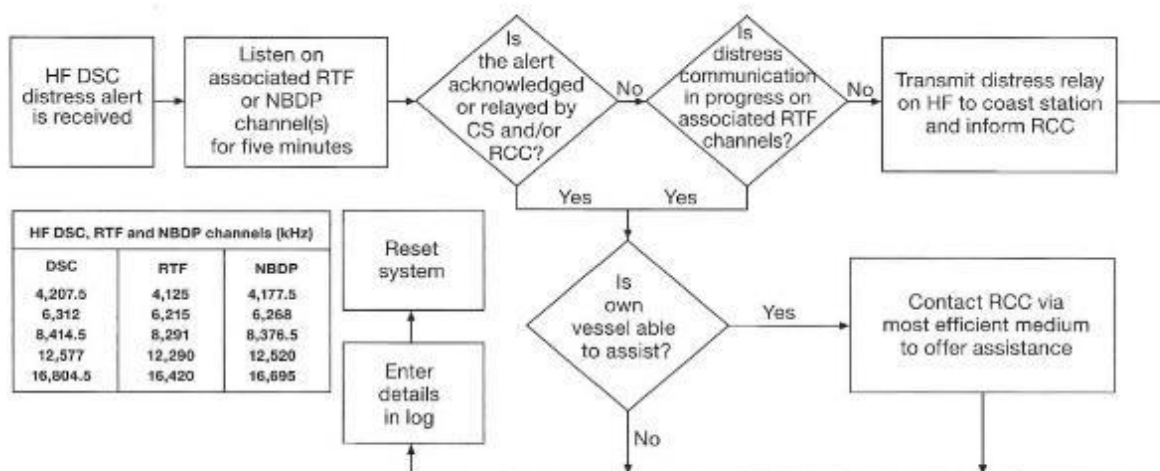

Remarks

Note 1: If it is clear the ship or persons in distress are not in the vicinity and/or other crafts are better placed to assist, superfluous communications which could interfere with search and rescue activities are to be avoided. Details should be recorded in the appropriate book.

Note 2: The ship should establish communications with the station controlling the distress as directed and render such assistance as required and appropriate.

Note 3: Distress relay calls should be initiated manually.

CS = coast station RCC = rescue co-ordination centre

Actions by ships upon reception of HF DSC distress alert

- gather the following information from the craft in distress if possible:
 - position of distressed craft
 - distressed craft's identity, call sign, and name
 - number of persons on board

- nature of the distress or casualty
- type of assistance required
- number of victims, if any
- distressed craft's course and speed
- type of craft, and cargo carried
- any other pertinent information that might facilitate the rescue
- maintain a continuous watch on the following international frequencies, if equipped to do so:
 - 2182 kHz (radiotelephony)
 - 156.8 MHz FM (channel 16, radiotelephony) for vessel distress
 - 121.5 MHz AM (radiotelephony) for aircraft distress or beacon distress signals.

Vessels subject to the SOLAS Convention must comply with applicable equipment carriage and monitoring requirements.

- ~~SOLAS communications equipment is referred to as Global Maritime Distress and Safety System (GMDSS)~~ GMDSS equipment and includes:
 - ~~Inmarsat~~ IMO recognized mobile satellite service ship earth stations
 - VHF, MF, and HF digital selective calling (DSC) DSC radios
 - maritime safety information receivers like NAVTEX and SafetyNET
 - hand-held VHF equipment
 - EPIRBs emergency position indicating radio beacons (EPIRBs)
 - SARTs search and rescue radar transponders (SARTs)
 - AIS-SARTs AIS search and rescue transmitters (AIS-SARTs).
- Any vessel carrying GMDSS-compatible equipment should use it as intended, and must be prepared at all times to receive distress alerts with it (~~see figures on pages 2-3 and 2-4~~).

Vessels should maintain communications with the distressed craft while advising an RCC or CRS of the situation.

- The following information should be communicated to the distressed craft:
 - own vessel's identity, call sign, and name
 - own vessel's position
 - own vessel's speed and ~~estimated time of arrival (ETA)~~ ETA to distressed craft site
 - distressed craft's true bearing and distance from ~~ship~~ own vessel.
- Use all available means to remain aware of the location of distressed craft (such as radar plotting, chart plots, ~~automatic identification system (AIS)~~ AIS and ~~Global Navigation Satellite System (GNSS)~~ GNSS).
- When in close proximity, post extra look-outs to keep distressed craft in sight.
- The ship or a CRS coordinating distress traffic should establish contact with an RCC and pass on all available information, updating as necessary.

Proceeding to the area of distress

- Establish a traffic coordinating system among vessels proceeding to the same area of distress.
- Maintain, if possible, AIS data and active radar plots on vessels in the general vicinity.
- Estimate the ETAs to the distress site of other assisting vessels.
- Assess the distress situation to prepare for operations on-scene.

On board preparation

- A vessel en route to assist a distressed craft should prepare for possible SAR action on scene, including the possible need to recover people from survival craft or from the water. See "~~Recovery of survivors by assisting vessels~~" later in this section 14.
- Masters of vessels proceeding to assist should assess the risks they may encounter on scene, including the risks such as those associated with leaking cargo, etc. Information should be sought as necessary from the distressed craft and/or from the RCC.
- A vessel en route to assist a distressed craft should have the following equipment ready for use if possible:

Life-saving and rescue equipment:

- specialized recovery equipment
- lifeboat
- inflatable liferaft
- lifejackets
- survival suits
- lifebuoys
- breeches buoys
- portable VHF radios for communication with the ship and boats deployed
- line-throwing apparatus
- buoyant lifelines
- hauling lines
- non-sparking boat hooks or grappling hooks
- hatchets
- rescue baskets
- stretchers
- pilot ladders
- scrambling nets
- copies of the International Code of Signals
- radio equipment operating on MF/HF and/or VHF/UHF and capable of communicating with the RCC and rescue facilities, and with a facility for direction finding (DF)

- supplies and survival equipment, as required
- fire-fighting equipment
- portable ejector pumps
- binoculars
- cameras
- bailers and oars.

Signalling equipment:

- signalling lamps
- searchlights
- torches
- flare pistol with colour-coded signal flares
- buoyant VHF/UHF marker beacons
- floating lights
- smoke generators
- flame and smoke floats
- dye markers
- loud hailers.

Preparations for medical assistance:

- stretchers
- blankets
- medical supplies and medicines
- clothing
- food
- shelter.

Miscellaneous equipment:

- A crane or other lifting equipment on either side of the ship, fitted with a recovery device.
- Line running from bow to stern at the water's edge on both sides for boats and craft to secure alongside.
- On the lowest weather deck, pilot ladders and manropes to assist survivors boarding the vessel.
- Vessel's lifeboats ready for use as a boarding station.
- Line-throwing apparatus ready for making connection with either ship in distress or survival craft.
- Floodlights set in appropriate locations, if recovery at night.

Vessels not assisting

The master deciding not to proceed to the scene of a distress due to sailing time involved and in the knowledge that a rescue operation is under way should:

- Make an appropriate entry in the ship's log-book.
- If the master had previously acknowledged and responded to the alert, report the decision not to proceed to the SAR service concerned.
- Consider reports unnecessary if no contact has been made with the SAR service.
- Reconsider the decision not to proceed nor report to the SAR service when vessel in distress is far from land or in an area where density of shipping is low.

Section 7 – Initial action by assisting aircraft

Section contents

Distress call and message received

Immediate action

Proceeding to area of distress

Navigation equipment

Communications equipment

Miscellaneous equipment

Distress call and message received

- Aircraft may receive a distress call or message from craft directly or by relay via an ATS unit.
- Aircraft over the sea may receive a distress call or other emergency information from a vessel. This usually occurs by relay from an RCC.
- Aircraft may receive a distress signal aurally from an EPIRB, ELT or PLB on 121.5 MHz.
- Aircraft near a distressed craft may receive visual signals.

Immediate action

- Reports should be evaluated to determine their validity and degree of urgency.
- Any aeronautical station or aircraft knowing of an emergency incident should relay the MAYDAY or transmit a distress message whenever such action is necessary to obtain assistance for the person, aircraft, or vessel in distress.
- In such circumstances, it should be made clear that the aircraft transmitting the message is not itself the distressed craft.

Proceeding to area of distress

In proceeding to an area of distress, prepare to assist the distressed craft. Categories to consider include:

Navigation equipment

- Aircraft designated for SAR operations should be equipped to receive and home in on:
 - radio transmissions
 - 406/121.5 MHz distress beacons (ELTs, EPIRBs and PLBs)
 - SARTs
 - AIS transmitters.
- Precise navigation equipment such as GNSS can be helpful in covering a search area carefully or locating a datum.

Communications equipment

- All aircraft should be equipped to maintain good communications with the RCC and other aeronautical SAR facilities.
- Designated SAR aircraft engaged in SAR operations at sea should be equipped to communicate with vessels and survival craft.
- Designated SAR aircraft should be able to communicate with survivors on VHF-FM on channel 16 (156.8 MHz) and VHF-AM on 121.5 MHz as a minimum.
- Carriage of droppable radios operating on 123.1 MHz and/or channel 16 can be used for communications with survivors.
- Carriage of portable radios may be appropriate for aircraft SAR units to communicate with maritime or land SAR facilities and OSCs.

Miscellaneous equipment

- The following equipment, as appropriate, should be readily available for SAR operations:
 - binoculars
 - a copy of the International Code of Signals
 - signalling equipment, such as pyrotechnics
 - buoyant VHF/UHF marker beacons, floating lights
 - fire-fighting equipment
 - cameras for photographing wreckage and location of survivors
 - first-aid supplies
 - loudhailers
 - containers for dropping written messages
 - inflatable liferafts
 - lifejackets and lifebuoys
 - portable hand-held battery-powered droppable radio for communicating with survivors
 - any equipment which may assist with rescue operations.

Section 8 – On-scene communications

Section contents

Survival and emergency radio equipment

Radio frequencies available for distress, maritime safety and SAR comms

Maritime

Aeronautical

Land

Visual communications

Vessel / aircraft communications

Radio

Visual

RCC communications

Maritime safety information

Phonetic alphabet and figure code

On-scene communications

Multiple aircraft communications

Long range radio communications

Survival and emergency radio equipment

- Aeronautical and maritime survival radio equipment operates on 121.5 MHz, a frequency which can be used for homing and on-scene communications, depending on equipment design.
- ~~Ultra-high frequency (UHF)~~ UHF 406 MHz is reserved solely as an alerting frequency for ELTs, EPIRBs, and PLBs.
- The following frequencies are available for use in vessel and aircraft survival craft, and may be used by portable survival radios on land:
 - 2182 kHz
 - 121.5 MHz
 - 156.8 MHz.
- Many civil aircraft worldwide, especially operating on international flights and over ocean areas, carry the 406 MHz distress beacon for alerting and homing. Some national regulations may allow for 121.5 MHz distress beacons on domestic flights.
 - SAR aircraft should be able to home on the 121.5 MHz homing frequency on the 406 MHz distress beacon, and the capability exists to home on the 406 MHz signal itself.
 - EPIRBs and ELTs operate on the 406 MHz frequency and are required to be carried on board certain vessels and aircraft, respectively. The 406 MHz PLB is not required internationally but can be carried on a person.
 - 406 MHz distress beacons (ELTs, EPIRBs and PLBs) offer coded identities and other advantages which can reduce SAR response time by up to several hours over what would be possible with non-coded ELTs.

- SOLAS ships should have a SART to interact with 9 GHz vessel or aircraft radars for locating survival craft (SART responses show up as a distinctive line of about 20 equally-spaced blips on compatible radar displays, providing a bearing and range to the SART).
- AIS-SART (~~automatic identification system — search and rescue transmitter~~) is an alternative to survival craft radar transponders. AIS-SART is a transmitter which sends a signal to the AIS. It is programmed with a unique identity code and receives its position via an internal GNSS. The AIS-SART is detected on both AIS class A and B and AIS receivers. The AIS target will be shown on ECDIS or chart plotters as a red circle with a cross inside.
- Ships of 300 gross tonnes and over are not required by SOLAS to carry radio apparatus for survival craft capable of transmitting and receiving on 2182 kHz (telephony), but this frequency can still be expected to be used.
 - Ships over 300 gross tonnes must carry at least two portable survival craft VHF transceivers.
 - Ships over 500 gross tonnes must carry at least three portable survival craft VHF transceivers.
 - If they operate in the 156–174 MHz band, they will use channel 16 and at least one other channel in this band.
 - Portable DSC equipment, if capable of operating in the indicated bands, can transmit on at least one of the following frequencies: 2187.5 kHz, 8414.5 kHz, or channel 70 VHF.
 - Distress beacon (~~ELT and EPIRB~~) signals indicate that a distress exists and facilitate location of survivors during SAR operations. To be effective, searching craft should be able to home on the signals intended for this purpose, or on the alerting frequency itself (which will be non-continuous if it is 406 MHz).

Radio frequencies available for distress, maritime safety and SAR communications

- The frequencies in the following tables are available for safety purposes, distress communications, and SAR operations.

Frequencies for use in the GMDSS

DSC distress and safety calling	Radiotelephony distress and safety traffic	NBDP distress and safety traffic
2,187.5 kHz	2,182.0 kHz	2,174.5 kHz
4,027.5 kHz	4,125.0 kHz	4,177.5 kHz
6,312.0 kHz	6,215.0 kHz	6,268.0 kHz
8,414.5 kHz	8,291.0 kHz	8,376.5 kHz
12,577.0 kHz	12,290.0 kHz	12,520.0 kHz
16,804.5 kHz	16,420.0 kHz	16,695.0 kHz
156.525 MHz (VHF channel 70)	156.8 MHz (VHF channel 16)	
MSI NBDP broadcasts by coast radio and earth stations		
490.0 kHz	518.0 kHz	
4,209.5 kHz*	4,210.0 kHz	
6,314.0 kHz	8,516.5 kHz	
12,579.0 kHz	16,806.5 kHz	
19,680.5 kHz	22,376.0 kHz	26,100.5 kHz
On-scene search and rescue radiotelephony		
2,182.0 kHz (R/T)		
3,023.0 kHz (Aeronautical frequency)		
4,125.0 kHz (R/T)		
5,680.0 kHz (Aeronautical frequency)		
123.1 MHz (Aeronautical frequency)		
156.8 MHz (VHF channel 16)		
156.5 MHz (VHF channel 10)		
156.3 MHz (VHF channel 6)		
Locating/homing signals		
121.5 MHz (homing)		
156–174 MHz (VHF maritime band – radiotelephony)		
406.0–406.1 MHz (Cospas–Sarsat satellite locating)		
9,200 to 9,500 MHz (X-band radar transponders – SART)		

**Alerting, SAR operations, maritime safety,
distress and safety, and survival craft frequencies** *(continued)*

Function	System	Frequency
Distress and safety traffic	Satellite	1,530–1,544 MHz (space-to-earth) and 1,626.5–1,646.5 MHz (earth-to-space)
	Radiotelephony	2,182 kHz 4,125 kHz 6,215 kHz 8,291 kHz 12,290 kHz 16,420 kHz 156.8 MHz
	NBDP	2,174.5 kHz 4,177.5 kHz 6,268 kHz 8,376.5 kHz 12,520 kHz 16,695 kHz
Survival craft	VHF radiotelephony	156.8 MHz and one other frequency in the 156–174 MHz band
	9 GHz radar transponders (SART)	9,200–9,500 MHz
	AIS–SART	161.975 MHz/162.025 MHz

- ¹ Frequency 156.525 MHz is used for ship-to-ship alerting and, if within sea area A1, for ship-to-shore alerting.
- ² For ships equipped with MF/HF DSC equipment, there is a watch requirement on 2,187.5 kHz, 8,414.5 kHz, and one other frequency.
- ³ Frequency 2,187.5 kHz is used for ship-to-ship alerting and, if within sea area A2, for ship-to-shore alerting.
- ⁴ Frequencies 156.3 and 156.8 MHz may also be used by aircraft for safety purposes only.
- ⁵ Frequency 121.5 MHz may be used by ships for distress and urgency purposes.
- ⁶ The priority of use for ship–aircraft communication is 4,125 kHz. Additionally, frequencies 123.1 MHz, 3,023 kHz, and 5,680 kHz may be used for intercommunication between mobile stations and these stations and participating land stations engaged in coordinated search and rescue operations.
- ⁷ The international NAVTEX frequency 518 kHz is the primary frequency for the transmission by coast stations of maritime safety information by NBDP. The other frequencies are used only to augment the coverage or information provided on 518 kHz.
- ⁸ Frequency 4,209.5 kHz is not used by all States.

**Alerting, SAR operations, maritime safety,
distress and safety, and survival craft frequencies**

Function	System	Frequency
Alerting	406 MHz distress beacon	406–406.1 MHz (earth-to-space)
	Inmarsat SES	1,544–1,545 MHz (space-to-earth) 1,626.5–1,646.5 MHz (earth-to-space) 1,645.6–1,645.8 MHz (earth-to-space)
	VHF DSC (channel 70)	1,56.525 MHz ¹
	MF/HF DSC ²	2,187.5 kHz ³ 4,207.5 kHz 6,312 kHz 8,414.5 kHz 12,577 kHz 16,804.5 kHz
	VHF AM	121.5 MHz
	VHF FM (channel 16)	156.8 MHz
	On-scene communications	VHF channel 16
VHF channel 06		156.3 MHz
VHF AM		123.1 MHz
MF radiotelephony		2,182 kHz
MF NBDP		2,174.5 kHz
Communications involving aircraft	On-scene, including SAR radiotelephony	156.8 MHz ⁴ 121.5 MHz ⁵ 123.1 MHz 156.3 MHz 2,182 kHz 3,023 kHz 4,125 kHz 5,680 kHz ⁶
Homing signals	406 MHz distress beacons	121.5 MHz and the 406 MHz signal
	9 GHz radar transponders (SART)	9,200–9,500 MHz
Maritime safety information (MSI)	NAVTEX Warnings	518 kHz ⁷
	NBDP	490 kHz 4,209.5 kHz ⁸ 4,210 kHz 6,314 kHz 8,416.5 kHz 12,579 kHz 16,806.5 kHz 19,680.5 kHz 22,376 kHz 26,100.5 kHz
	Satellite SafetyNET	1,530–1,545 MHz (space-to-earth)
Safety of navigation	VHF channel 13	156.650 MHz

Maritime

- Ships transmitting a distress message on any of the above frequencies should use the appropriate procedures.

Aeronautical







- The aeronautical frequencies 3023 kHz and 5680 kHz may be used for communications by ships and participating CRSs/RCCs engaged in coordinated SAR operations. However, since these frequencies may not be continuously monitored, shore authorities may be needed to help establish communications on these frequencies.

Land











- Land SAR can be conducted for many types of incidents, ranging from a downed aircraft to a hiker lost in the wilderness. Land facilities and aeronautical facilities may conduct coordinated land searches. Since each normally operates on different radio frequencies, advance coordination amongst local agencies may be necessary to establish effective communications.
 - Aircraft typically have at least one radio, so it may be easiest for the air facility and land facility to use an aeronautical frequency.
 - If the land facility does not have a portable aircraft radio, then communications may be provided by equipping an aircraft with a radio operating on ground frequencies.

Visual communications









- The following visual means of communication should be used when appropriate:
 - signalling lamp
 - international code flags
 - international distress signals.
- The following tables describe the life-saving signals referred to in regulation V/29 of SOLAS 1974, as amended, and are intended for use by:
 - SAR facilities engaged in SAR operations when communicating with ships or persons in distress
 - ships or persons in distress when communicating with SAR facilities.

	MANUAL SIGNALS	LIGHT SIGNALS	OTHER SIGNALS	MEANING
Day signals	 Vertical motion of a white flag or of the arms	 or firing of a green star signal	 or code letter K given by light or sound-signal apparatus	This is the best place to land
Night signals	 Vertical motion of a white light or flare	 or firing of a green star signal	 or code letter K given by light or sound-signal apparatus	



A range (indication of direction) may be given by placing a steady white light or flare at a lower level and in line with the observer.

Day signals	 Horizontal motion of a white flag or of the arms extended horizontally	 or firing of a red star signal	 or code letter S given by light or sound-signal apparatus	Landing here highly dangerous
Night signals	 Horizontal motion of a light or flare	 or firing of a red star signal	 or code letter S given by light or sound-signal apparatus	
Day signals	 1 Horizontal motion of a white flag, followed by 2 the placing of the white flag in the ground and 3 by the carrying of another white flag in the direction to be indicated	 1 or firing of red star signal vertically and 2 a white star signal in the direction towards the better landing place	1 or signalling the code letter S (...) followed by the code letter R (...) if a better landing place for the craft in distress is located more to the right in the direction of approach 2 or signalling the code letter S (...) followed by the code letter L (...) if a better landing place for the craft in distress is located more to the left in the direction of approach	Landing here highly dangerous. A more favourable location for landing is in the direction indicated
Night signals	 1 Horizontal motion of a white light, or flare 2 followed by the placing of the white light or flare on the ground and 3 the carrying of another white light or flare in the direction to be indicated	 1 or firing of red star signal vertically and a 2 white star signal in the direction towards the better landing place	1 or signalling the code letter S (...) followed by the code letter R (...) if a better landing place for the craft in distress is located more to the right in the direction of approach 2 or signalling the code letter S (...) followed by the code letter L (...) if a better landing place for the craft in distress is located more to the left in the direction of approach	

Landing signals for the guidance of small boats with crews or persons in distress

	MANUAL SIGNALS	LIGHT SIGNALS	OTHER SIGNALS	MEANING
Day signals	 Vertical motion of a white flag or of the arms	 or firing of a green star signal		In general: affirmative Specifically: rocket line is held – tail block is made fast – hawser is made fast – man is in the breeches buoy – haul away
Night signals	 Vertical motion of a white light or flare	 or firing of a green star signal		
Day signals	 Horizontal motion of a white flag or of the arms extended horizontally	 or firing of a red star signal		In general: negative Specifically: slack away – avast hauling
Night signals	 Horizontal motion of a white light or flare	 or firing of a red star signal		

Signals to be employed in connection with the use of shore life-saving apparatus

Day signals	 Orange smoke signal	 or combined light and sound signal (thunder-light) consisting of 3 single signals which are fired at intervals of approximately one minute	You are seen – assistance will be given as soon as possible (Repetition of such signal shall have the same meaning)
Night signals	 White star rocket consisting of 3 single signals which are fired at intervals of approximately one minute		





If necessary, the day signals may be given at night or the night signals by day.

Replies from life-saving stations or maritime rescue units to distress signals made by a ship or person

Signals used by aircraft engaged in search and rescue operations to direct ships towards an aircraft, ship or person in distress

PROCEDURES PERFORMED IN SEQUENCE BY AN AIRCRAFT





MEANING

 <p>1 CIRCLE the vessel at least once.</p>	 <p>2 CROSS the vessel's projected course close AHEAD at a low altitude while ROCKING the wings. (See Note).</p>	 <p>3 HEAD in the direction in which the vessel is to be directed.</p>	<p>The aircraft is directing a vessel towards an aircraft or vessel in distress.</p> <p>(Repetition of such signals shall have the same meaning)</p>
<p>CROSS the vessel's wake close ASTERN at low altitude while ROCKING the wings. (See Note)</p>  <p>NOTE Opening and closing the throttle or changing the propeller pitch may also be practiced as an alternative means of attracting attention to that of rocking the wings. However, this form of sound signal may be less effective than the visual signal of rocking the wings owing to high noise level on board the vessel.</p>			<p>The assistance of the vessel is no longer required.</p> <p>(Repetition of such signals shall have the same meaning)</p>

Air-to-surface visual signals

Signals used by a vessel in response to an aircraft engaged in search and rescue operations

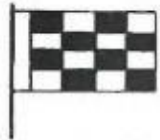
MEANING

 <p>Hoist "Code and Answering" pendant Close up; or</p>	 <p>Change the heading to the required direction; or</p>	 <p>Flash Morse Code signal "T" by signal lamp.</p>	<p>Acknowledges receipt of aircraft's signal</p>
 <p>Hoist international flag "N" (NOVEMBER); or</p>		 <p>Flash Morse Code signal "N" by signal lamp.</p>	<p>Indicates inability to comply</p>

- Use the following surface-to-air visual signals by displaying the appropriate signal on the deck or on the ground:

Message	ICAO-IMO visual signals
Require assistance	V
Require medical assistance	X
No or negative	N
Yes or affirmative	Y
Proceeding in this direction	↑

Surface-to-air visual signals

Vessel-aircraft communications

- Civil vessels and aircraft may need to communicate with each other if either is in an emergency situation or communicating with SAR facilities.
- Since these occasions may be infrequent, civil aircraft usually do not carry additional equipment for these purposes; incompatible equipment may make communications difficult.
- The aeronautical mobile service uses amplitude modulation (AM) for VHF telephony while the maritime mobile service uses frequency modulation (FM).
- Except for SRUs, vessels normally cannot communicate on 3023 and 5680 kHz, or on 121.5 and 123.1 MHz.
- The following frequencies may be used for safety communications between vessels and aircraft when compatible equipment is available:

2182 kHz

- many vessels, especially fishing vessels, and nearly all ships, are equipped to use 2182 kHz
- some transport aircraft can transmit on 2182 kHz, and aircraft designated for maritime SAR operations are required to carry this frequency
- aircraft may have difficulty calling up vessels on 2182 kHz, as vessels normally guard this frequency through automatic means, and are alerted when an MF DSC alert is transmitted

4125 kHz

- this frequency may be used by aircraft to communicate with ships for distress and safety purposes
- all ships may not carry this frequency

- if an aircraft needs help from a ship, SAR authorities can notify ships in the vicinity of the situation and ask them, if practicable, to set up watch on frequency 4125 kHz

3023 and 5680 kHz

- these are HF on-scene radiotelephony frequencies for SAR
- most designated SAR aircraft and some civil aircraft carrying HF equipment can operate on these frequencies
- they may also be used by vessels and CRSs engaged in coordinated SAR operations

121.5 MHz AM

- this is the international aeronautical distress frequency
- all designated SAR aircraft and civil aircraft carry equipment operating on 121.5 MHz
- it may also be used by ground stations or maritime craft for safety purposes
- all aircraft should guard this frequency, flight-deck duties and equipment limitations permitting

123.1 MHz AM

- this is the aeronautical on-scene frequency which may be jointly used by aircraft and vessels engaged in SAR operations

156.8 MHz FM

- this is the VHF maritime distress frequency (channel 16) carried by most ships and many other maritime craft
- civil aircraft do not normally carry radios which can use this frequency, but some aircraft which regularly fly over water do, usually in portable equipment
- designated SAR aircraft should be able to use this frequency to communicate with vessels in distress and assisting vessels.

- Once alerted, RCCs can often help aircraft make arrangements for direct communications with vessels, or provide a message relay.

Radio

- The different maritime and aeronautical radio bands make direct communications between vessel (especially merchant vessel) and aircraft difficult.
- Most civil aircraft flying over ocean areas are equipped with VHF/AM radios (118–136 MHz) and HF/SSB radios (3–20 MHz). Military aircraft normally have UHF radios (225–399.9 MHz) and HF/SSB radios (3–30 MHz).
- In emergencies, the pilot normally advises an ATS unit of the situation and intentions.
- If not able to continue toward an aerodrome, the pilot usually asks the ATS unit to seek advice of any ships in the area. The appropriate RCC can assist the ATS unit.

- Merchant ships are ordinarily informed of aircraft distress situations by broadcast messages from a CRS or RCC on the international maritime distress frequencies. Few aircraft can operate on these frequencies.
- Emergency communications are usually established with aircraft on 4125 kHz or 5680 kHz.
- Communication between an aircraft and a vessel often may have to be relayed via a SAR aircraft, military vessel, or ground station.

Visual

- While there is no standard emergency signal to indicate ditching, an aircraft in distress can use any means to attract attention, make its position known, and obtain help.
- Lowering landing gear and flashing landing lights on and off may be used to signal ditching intentions.

Communications

RCC communications

- RCCs are normally contacted by:
 - dedicated phone number
 - email
 - fax
 - coastal radio station
 - satellite land earth station
 - direct satellite communication, or
 - HF, MF or VHF radio.
- For information on contact details for RCCs, refer to the Admiralty List of Radio Signals (ALRS) Volume V or the appropriate Aeronautical Information Publication.

Maritime safety information

NAVTEX is used to promulgate initial distress and urgency alerts and navigation and safety warnings to vessels.

~~The World-wide Navigational Warning System (WWNWS) is for~~ Long-range NAVAREA warnings and coastal NAVTEX warnings. are promulgated over internationally and nationally coordinated World-wide Navigational Warning Service (WWNWS).

- It provides for globally coordinated transmissions through NAVAREA coordinators for each NAVAREA
- Warnings which SAR authority may send over WWNWS include:
 - distress alerts
 - information about overdue or missing aircraft or vessels

Collectively, these types of alerts, combined with navigation and meteorological warnings, are called maritime safety information (MSI).

Inmarsat is also used to broadcast MSI via SafetyNET.

SafetyNET provides an automatic, global method of broadcasting SAR messages to vessels in both fixed and variable geographic areas. A similar service of Inmarsat called FleetNET can be used to send shore-to-ship messages to predetermined groups of vessels.

- RCCs normally relay distress alerts over both NAVTEX and SafetyNET.
- Normally, SAR broadcasts over SafetyNET are sent to all vessels within a desired radius of a specified position.

Phonetic alphabet and figure code

The phonetic alphabet and figure code is sometimes necessary to use when speaking or spelling out call signs, names, search area designations, abbreviations, etc.

A complete listing of the phonetic alphabet, figure code, and Morse signals is found in the International Code of Signals (~~INTERCO~~).

On-scene communications

The OSC should ensure that reliable communications are maintained on-scene.

- Normally, the SMC will select SAR-dedicated frequencies for use on-scene, inform the OSC or SAR facilities, and establish communications with adjacent RCCs and parent agencies of SAR facilities as appropriate.
 - the OSC should maintain communications with all SAR facilities and the SMC
 - a primary and secondary frequency should be assigned for on-scene communications
- If there are several aircraft involved in the SAR operation and the OSC does not have specific aircraft coordination capability, an aircraft coordinator (ACO) should be appointed to assist in maintaining flight safety and to handle communications with the aircraft on scene.
- If there are relatively few units responding communications may be kept on one coordinating frequency.
- In more complex cases communications should be divided for the sake of efficiency and avoidance of frequency congestion.
 - a ship casualty, the OSC and the ACO should work VHF channel 16
 - other units on scene should use working frequencies for their own part of the operation. Surface units usually use VHF channel 6, coordinated by the OSC. Aircraft coordinated by an ACO should use 123.1 MHz
 - these units should also monitor the main coordination frequency if possible so as to maintain an overall understanding of the situation. SITREPs may be used by the OSC to keep all units fully informed
 - other frequencies may be used, as directed by the OSC, for specific operations, for example, a winching operation between helicopter and ship, or a surface search being conducted by some units as part of a wider operation.

A basic communications plan structure is shown below.

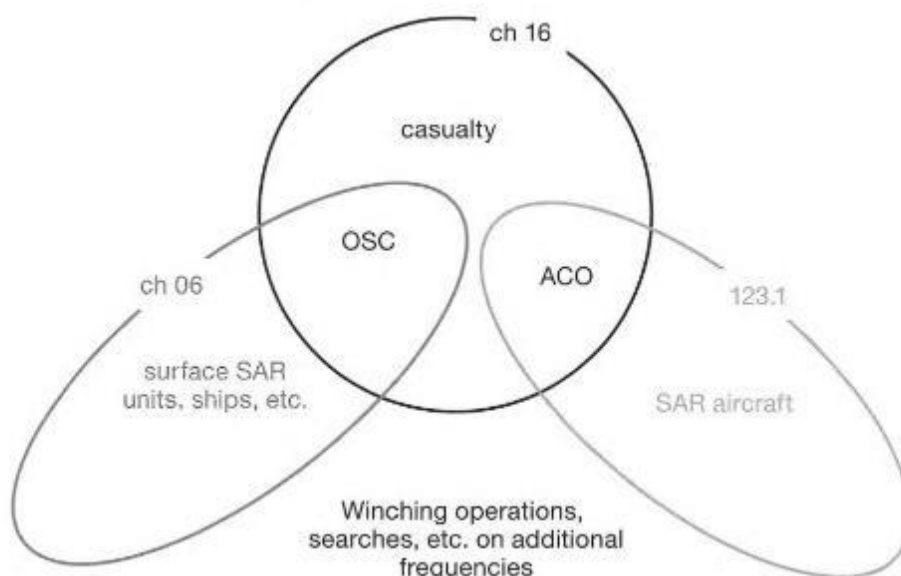

On-scene radiocommunications

- The OSC should coordinate communications on-scene and ensure that reliable communications are maintained.
 - SAR facilities normally report to the OSC and/or ACO on an assigned frequency
 - if a frequency change is carried out, instructions should be provided about what to do if intended communications cannot be re-established on the new frequency
 - all SAR facilities should carry a copy of the International Code of Signals (**INTERCO**), which contains internationally recognized communications information. ~~for use with aircraft, vessels, and survivors~~

Multiple aircraft communications

Radio voice communications

There should be agreed, common, on-scene procedures for the following:

- ~~On-scene Coordination Frequency.~~ An agreed coordination frequency for radio voice communications should be used within an area of SAR action ~~or near the scene of operations.~~ This ~~The~~ frequency selected should be one ~~that~~ which all aircraft can access, together with the ACO. Information that should be passed between an ACO and SAR aircraft ~~are~~ ~~is~~ listed in appendices H-3, H-4 and H-5.
- ~~Alternative Frequencies.~~ Alternative frequencies should also be nominated by an ACO, if the agreed coordination frequency is likely to become too busy or unusable.
- ~~Capabilities.~~ Care should be taken to ensure that aircraft and surface units involved in an operation are capable of complying with the communications procedures.

- ~~Communications with an OSC.~~ Consideration should be given to enabling communications between an ACO and an OSC. However, it should not normally be necessary for SAR aircraft other than an ACO to communicate directly with the OSC.
- ~~Radio Communications Failure Procedures.~~ All SAR plans for multiple aircraft SAR operations should include procedures for use when radio communications fail. A failure of radio communications might affect aircraft, SRUs or persons in distress individually, or might involve a compromise of radio systems affecting several participants. The systems affected might include radio voice communications or radio systems designed to indicate the positions of aircraft, vessels or people, including transponders and other devices. In general, the following principles should apply to most situations in which radio communications fail:
 - A backup means of radio voice communication should be determined and then nominated by an ACO, along with the normal communications plan.
 - The backup radio voice communications might include alternative frequencies, alternative radio communications systems or both. In the event of a radio communications failure, with no alternative airborne communications available, aircraft should normally continue with their planned timings, events and flight path, still transmitting all position and altitude reports, until they are clear of the immediate on-scene area.
 - If an aircraft has not been given a plan when a radio communications failure occurs, then it should avoid the on-scene area, departing by an appropriate route and ~~heights~~ **height**.
 - Once clear of the on-scene area, aircraft should consider moving near or landing at a suitable facility in order to establish communications by alternative methods.

If radio voice communications cannot be restored, then alternative procedures could be considered such as increasing the distances between aircraft using time. If not already included in SAR plans, then all participating airborne SRUs might have to be assembled together in order for this procedure to be briefed and understood. In most cases, this would result in considerable delays to a SAR operation.

A diagram illustrating a basic example of communications during multiple aircraft SAR operations, involving an aircraft ACO, is as follows:

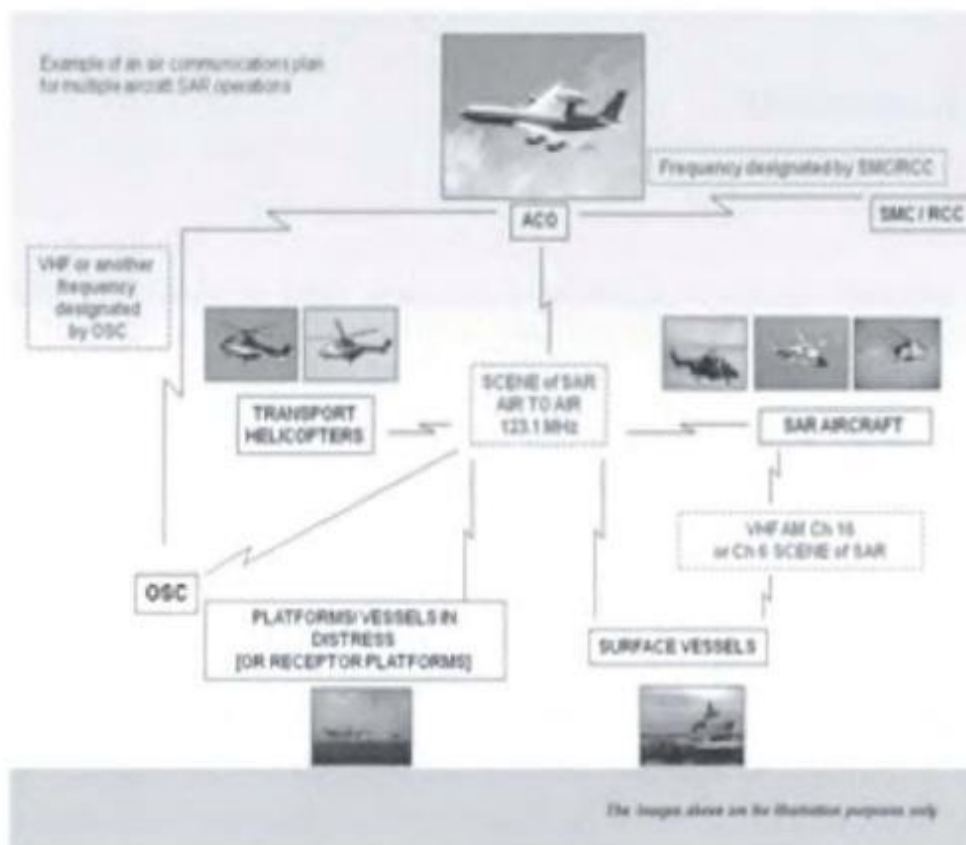

Long range radio communications

Communications systems designed for long range SAR operations can be different from the types of communications used at shorter ranges.

~~Some long~~ Long range communications methods include the following:

- High Frequency radio systems
- Satellite communications systems
- Position tracking systems, including those that enable two-way communications
- The use of high flying aircraft to relay VHF radio communications to and from lower flying SAR aircraft
- Relay of information to and from SAR aircraft through ATS units
- Relay of information by ships at sea able to communicate with SAR aircraft on marine band VHF frequencies, whilst a shore-based RCC uses satellite, MF or HF communications to communicate with the relaying ship(s)
- Relay of information by any surface units able to communicate with both SRUs and SMCs.

Section 9 – On Scene Coordinator

Section contents

- Requirements for coordination
- On-scene coordination
- Designation of on-scene coordinator (OSC)
- OSC duties and responsibilities
- SAR operation risks
- SAR briefing, debriefing, and tasking
- Situation reports

Requirements for coordination

When a SAR incident occurs, an SMC will normally be designated, within an RCC. The SMC will obtain SAR facilities, plan SAR operations, and provide overall coordination. The SMC may also designate an OSC to provide coordination at the scene to carry out plans to locate and rescue survivors. If no SMC has been designated or communications between the SMC and OSC are lost, the OSC may need to perform some additional functions normally handled by an SMC. It may be necessary to designate a vessel OSC for surface activities and an aircraft coordinator (ACO) for aircraft activities if vessel/aircraft communications on-scene are not practical.

Note: In practice, the terms RCC and SMC are often used interchangeably due to their close association.

- When a vessel or aircraft becomes aware of a SAR incident directly, it should alert the appropriate RCC as follows:
 - the RCC responsible for the SRR where the incident occurred
 - the nearest RCC
 - any RCC which can be reached; or
 - any communications facility (e.g. alerting post).
- The first facility to arrive in the vicinity of the SAR incident should assume OSC duties and, if necessary, SMC duties, until an SMC has been designated, and retain OSC duties until the SMC has designated an OSC.
- For the maritime environment, ship masters typically perform the OSC function due to ship endurance on-scene unless more capable SRUs are available.

On-scene coordination

- The types of facilities involved and the region of the SAR incident may affect on-scene coordination.
- Available facilities may include:
 - designated SRUs
 - civil aircraft and vessels, military and naval or other facilities with SAR capability.
- In remote regions, SAR aircraft may not always be available to participate.
- In most oceanic regions, ships will normally be available, depending on shipping density.

- Ships may receive information from land-based SAR authorities or by monitoring distress traffic.
- No advice received from these authorities can set aside the duties of any master as set forth in regulation V/33 of SOLAS 1974 (see appendix A).

Designation of on-scene coordinator (OSC)

- When two or more SAR facilities conduct operations together, the SMC may designate an OSC.
- If this is not practicable, facilities involved may designate, by mutual agreement, an OSC.
- This should, if necessary, be done as early as practicable and preferably before arrival of facilities on scene.
- Until an OSC has been designated, the first facility arriving at the scene should assume the duties of an OSC.
- When deciding how much responsibility to delegate to the OSC, the SMC normally considers the endurance, communication and personnel capabilities of the facilities involved.
 - The poorer the communications on scene with the RCC, the more authority the OSC will need to initiate actions.

OSC duties and responsibilities

- The OSC should obtain a search **and/or rescue** action plan from the SMC via the RCC as soon as possible.
 - Normally, search planning is performed using trained personnel, advanced search planning techniques, and information about the incident or distressed craft not normally available to the OSC. However, the OSC may still need to plan a search under some circumstances. Search operations should commence as soon as facilities are available at the scene. If a search plan has not been provided by the SMC, the OSC should do the planning until an SMC assumes the search planning function. Simplified techniques are presented ~~below~~ **in section 12**.
- **Provide information to and** coordinate operations of all SAR facilities on-scene. An ACO may be designated to coordinate aircraft operations.
- ~~– Carry out the search action plan or rescue action plan received from the SMC or plan the search or rescue operation, if no plan is otherwise available. (See Planning and conducting the search in this section.)~~
- Modify the plan as the situation on-scene dictates, keeping the SMC advised (discuss proposed modifications with the SMC when practicable).
- Coordinate on-scene communications.
- ~~– Provide relevant information to the other SAR facilities.~~
- **Monitor the performance of other participating facilities and ensure operations are conducted safely.**
- ~~– Ensure operations are conducted safely, paying particular attention to maintaining safe separations among all facilities, both surface and air.~~
- Make periodic situation reports (SITREPs) to the SMC. The standard SITREP format may be found in appendix D. SITREPs should include but not be limited to:

- weather and sea conditions
- the results of search and/or rescue action to date
- any modifications made or suggested to the action plan
- any future plans or recommendations.
- Maintain a detailed record of the operation:
 - on-scene arrival and departure times of SAR facilities, other vessels and aircraft engaged in the operation
 - areas searched
 - track spacing used
 - sightings and leads reported
 - actions taken
 - results obtained.
- Advise the SMC to release facilities no longer required.
- Report the number and names of survivors to the SMC.
- Provide the SMC with the names and designations of facilities with survivors on board.
- Report which survivors are in each facility.
- Request additional SMC assistance when necessary (for example, medical evacuation of seriously injured survivors)
- ~~— Modify search plans based on changes in the on-scene situation, such as:
 - ~~— arrival of additional assisting facilities~~
 - ~~— receipt of additional information~~
 - ~~— changes in weather, visibility, lighting conditions, etc.~~~~
- In case of language difficulties, the International Code of Signals, the IMO Standard Marine Communication Phrases (SMCP) and standard ICAO phraseology contained in Annex 10 to the Convention on International Civil Aviation and PANS-ATM (ICAO Document 4444) should be used.
- On assuming the duty, the OSC should inform the appropriate RCC, via a CRS or ATS unit as necessary, and keep it informed of developments at regular intervals.

SAR operation risks

- Safe and effective SAR operations depend on coordinated teamwork and sound risk assessment.
- Saving distressed persons, and the safety of assisting personnel, should both be of concern to the OSC.
- The leaders (captain, pilot-in-command, or OSC) must ensure that personnel perform properly as a team with a common mission.
 - Mishaps often follow a chain of errors that can start with mistakes made during SAR planning and lead to poor decisions during operations.
- Team safety is supported by:
 - proficiency in keeping everyone informed

- matching resource capabilities to tasks
- detecting and avoiding errors early
- following standard procedures
- adjusting to non-standard activities.
- Search and rescue action plans provided by the SMC are only guidance for the OSC and SAR facilities on-scene.
 - the OSC may adjust the plans, based on the situation, and inform the SMC (discuss proposed modifications with the SMC when practicable)
 - SAR facilities should keep the OSC advised of any difficulties or hazards encountered.
- The risks inherent in any SAR response must be considered against the chances for success and the safety of SAR personnel.
- Some practical concerns for assessing the situation include:
 - is the distressed craft in immediate danger of causing harm or placing the rescue facility in jeopardy?
 - can the rescue facility handle the weather conditions?
 - has the distressed craft given enough information to prepare the assisting vessel to aid in the rescue?
 - can the assisting facility realistically be of assistance?
- If recovery of a large number of survivors is a factor:
 - can the rescue facility accommodate them in regards to food, shelter, clothing, living space?
 - will the craft performing the rescue be stable with the survivors on board?
- If helicopter operations are a factor:
 - is the vessel's construction suitable for a vessel–aircraft joint operation?
 - does the rescue facility have enough crew members available to assist?

SAR briefing, debriefing, and tasking

- The SMC, OSC and/or ACO should provide information to SAR facilities on relevant details of the distress and all instructions prior to the conduct of SAR operations. Parent agencies may provide this information by briefing their facilities prior to deployment. Debriefings of the SAR facilities provide valuable information on effectiveness of the search and can influence planning of the next search. SAR facilities and the OSC should be aware of the type of information that the SMC is likely to request. Appendix E provides a sample SAR Briefing and Debriefing Form.
- Masters and pilots-in-command of SAR facilities not designated as search and rescue units should also be contacted by the SMC, OSC and/or ACO for debriefing.

Situation reports

- **SITREPs**
 - provide earliest notice of an emergency (short form)

- pass urgent essential details when requesting assistance (short form)
- pass amplifying or updating information during SAR operations (full form).
- The OSC uses SITREPs to keep the SMC informed of on-scene mission progress and conditions, and addresses SITREPs to the SMC unless otherwise directed. ~~Search SAR~~ facilities use SITREPs to keep the OSC informed.
- The SMC uses SITREPs to keep superiors, other RCCs, and any other interested agencies informed.
- Where pollution or threat of pollution exists from the vessel or aircraft casualty, the agency tasked with environmental protection should be an information addressee on SITREPs from the SMC.
- Initial SITREPs should be transmitted as soon as details of an incident become clear enough to indicate SAR involvement.
 - SITREPs should not be delayed unnecessarily for confirmation of all details.
 - Further SITREPs should be issued as soon as other relevant information is obtained.
 - Information already passed ~~should not~~ **does not need to** be repeated.
 - During prolonged operations, "no change" SITREPs should be issued at intervals of about three hours to reassure recipients that nothing has been missed.
 - When the incident is concluded, a "final" SITREP should be issued as confirmation.
- A standard SITREP format is shown in appendix D.
 - Each SITREP concerning the same incident should be numbered sequentially.
- SITREPs prepared on-scene usually provide the following information:

Identification

- usually in the subject line
- the SITREP number
- identification of the distressed craft
- a short description of the emergency
- numbered sequentially throughout the case
- when an OSC is relieved on-scene, the new OSC continues the SITREP numbering sequence

Situation

- a description of the case
- the conditions that affect the case
- any amplifying information that will clarify the problem
- after the first SITREP, only changes to the original reported situation need be included

Action taken

- a report of all action taken since the last report, including results of such action
- when an unsuccessful search has been conducted, the report includes:

- the areas searched
- hours searched
- factors that may have decreased search effectiveness, such as weather or equipment difficulties

Future plans

- description of actions planned for future execution
- recommendations
- request for additional assistance

Status of case

- this is normally used only on the final SITREP to indicate that the case is closed or that search is suspended pending further developments.

Section 10 – Multiple aircraft SAR operations

Section contents

General guidance

Number of SAR aircraft required and aircraft capabilities

Participation by other aircraft

Refuelling facilities

Area of SAR action

 Entering areas of SAR action

 Joining eEntry report

 Leaving areas of SAR action

 Flights in areas of SAR action by other aircraft

Safety flow procedures

Aircraft approach and departure flight paths

Instrument based procedures

Approach fallback procedures

General guidance

The information in this section provides guidance for the management and conduct of multiple aircraft SAR operations. Any of the described principles and procedures might have to be modified by SMCs, ACOs and SRUs, in order to deal with specific situations. ~~Further information on multiple aircraft SAR operations is available in IAMSAR Volume II, chapter 6.~~

Number of SAR aircraft required and aircraft capabilities

The RCC/OSC/ACO responsible for the SAR operation should aim to achieve the most effective blend of aircraft and surface unit capabilities ~~for the situations that are anticipated.~~ The operation should aim to achieve continuous or and efficient use of aircraft on scene when needed, while minimizing the

- Minimize situations in which aircraft are airborne without a mission.
- Where more aircraft than needed are available for a SAR operation, some can be held in reserve. These aircraft can provide additional resources if needed, or relieve other aircraft involved in the operation for reasons related to aircrew fatigue or maintenance requirements.

The RCC/OSC/ACO should define the number of aircraft to be used in a mission taking into account weather, distance from scene, nature of distress, available facilities and other operational issues. ~~The SMC ideally has the best overall picture of ongoing SAR operations. Therefore tasks given to aircraft may not necessarily always utilize all the capabilities available.~~

Given tasks should not rely on aircraft and aircrew conducting flying activities beyond their abilities, or their approved types of operations. In case such a task is given, the pilot-in-command shall inform the RCC/OSC/ACO immediately.

Participation by other supplementary aircraft with SAR capability

In some situations, such as mass evacuations from offshore drilling platforms, large scale incidents over land areas etc., supplementary aircraft with SAR capability belonging to commercial companies or other organizations might be able to respond to incidents as part of existing emergency plans.

Refueling facilities

The RCC/ACO/OSC is responsible for arranging refuelling facilities in a SAR operation. The pilot-in-command is responsible for ensuring that the facilities available are suitable, taking into account endurance and all operational needs. The pilot-in-command should take appropriate actions to ensure required refuelling and keep the RCC/ACO/OSC continuously informed of changes to on-scene and overall endurance.

Area of SAR action

Definition

~~For IAMSAR Manual purposes, a~~ An area of SAR action is an area of defined dimensions that is established, notified or agreed for the purposes of protecting aircraft during SAR operations and within which SAR operations take place.

Entering areas of SAR action

SAR aircraft intending to enter an area of SAR action should normally first contact the ACO relevant unit (RCC, ACO, OSC or responsible ATS unit). They should not enter the area until the ACO this unit gives them permission approval and provides them with sufficient information to safely join the flow of SAR aircraft involved in the operation (see also section 8 Communications). ~~Aircraft should call an ACO as early as possible before entering an area of SAR action, in order to allow time for information to be exchanged and in case they are required to remain clear of it. As a general guide,~~

- Aircraft should ~~aim to get in touch with an ACO~~ contact the ACO when at least ten minutes' flying time from the edge of an area of SAR action and pass entry information using the format described in appendix H-5.
- In the event that an area of SAR action has been established but an ACO is not yet available, SAR aircraft should receive information that they require primarily from the coordinating RCC or OSC.

Entry report

- Airborne SRUs should make ~~an a standard joining~~ entry report to the ACO when entering a search and rescue mission area, including:
 - call sign;
 - nationality;
 - type (specify fixed-wing or helicopter and type);
 - position;
 - altitude (on pressure setting used);
 - ETA (at relevant point or search area);
 - endurance on scene; and
 - remarks (specific equipment or limitations).

Leaving areas of SAR action

Aircraft leaving areas of SAR action should contact the ACO-relevant unit before the area boundary and before changing to another frequency. Aircraft leaving should use the format described in appendix H-5.

Flights in areas of SAR action by other aircraft

Aircraft that are not involved in a SAR operation should normally not fly within areas of SAR action. However, if such aircraft need to enter an area of SAR action, they should do so only with the approval of a SMC, ACO, OSC or coordinating ATS unit and are subject to the rules of the area or the relevant class of airspace. If an SMC or coordinating ATS unit is giving approval, the ACO or OSC should first be consulted.

Safety flow procedures

The main aim of on-scene procedures for multiple SAR aircraft operations should be safety. In general, there are two methods that can be used to ensure a safe flow of SAR-multiple aircraft, which are as follows:

- ~~Horizontal Spacing.~~ Horizontal spacing of aircraft operating visually should be the basic method used by SAR authorities and ACOs. It can be achieved by establishing coordinated specific routes to be flown by SAR aircraft to, from and within the area of SAR action.
- ~~Vertical Spacing.~~ For situations in which keeping aircraft apart horizontally will not ensure sufficient levels of safety, or if a cross-over of aircraft flight paths cannot be avoided, then, when weather permits, vertical spacing should be considered. It may not always be necessary for SAR aircraft to fly at different altitudes, unless they are likely to fly close to each other or their flight paths cross over. If a significant possibility of collision exists, then different altitudes should be assigned for SAR aircraft. Vertical spacing of aircraft can be used in combination with horizontal spacing for aircraft operating visually but is a key consideration for safety during poor weather conditions when more segregated operations are likely to be required.
- In general, altitudes for RPAs should be kept apart from altitudes allocated for other SAR aircraft.
- ~~Ideally, the most~~ An effective method to ensure a safe flow of aircraft is by using a combination of both horizontal and vertical spacing. The best way to achieve this is through planning by ~~an~~ the ACO, OSC or RCC and a clear understanding of procedures by all of the units and authorities involved.

The procedures used by SAR aircraft within an area of SAR action should be determined by the ACO in consultation with the SMC/OSC and pilots-in-command of the SAR aircraft. The use of assigned flight paths, coordinated timings and designated entry and exit procedures will help to ensure a safe flow of SAR aircraft. These can be determined by using bearings and distances from features such as the casualty location, or described using coordinates such as Latitude and Longitude. An effective way to organize multiple SAR aircraft engaged in an evacuation operation is to use procedures based on a central reference position (for example a vessel in distress).

Aircraft approach and departure flight paths

Approach and departure flight paths are usually influenced by the prevailing wind direction. Factors which might also have to be taken into account are:

- Fumes directly downwind from burning structures may be unsafe – the direction of approach for aircraft might have to be off-set from the wind direction.

- Geographic features or the design of the casualty location might compel aircraft to approach only from certain directions. Structures such as cranes, towers or vertical obstructions in line with the wind direction, might be dangerous as physical obstacles or due to mechanical turbulence created downwind.

Instrument based procedures

When weather conditions are so poor that flying operations cannot effectively be carried out according to visual procedures and the procedures described earlier in this section, then it might be possible for an aircraft to operate under instrument based procedures in an effort to establish visual conditions in the area of SAR action.

Unless operations are carried out in controlled airspace under the control of an ATS unit, aircraft pilots-in-command have full responsibility for avoiding other air traffic and surface obstructions in accordance with established regulations of their State for operations in Instrument conditions and transitioning to visual conditions.

Approach Fallback Procedures

If on scene conditions in an area of SAR action prevent a SAR aircraft from successfully completing an approach to the distress location, then an Approach Fallback Procedure should be flown in order to safely rejoin the flow or depart from the area. Approach Fallback Procedures must be briefed to all SAR aircraft by an ACO.

Section 11 – Aircraft Coordinator

Section contents

Designation of aircraft coordinator (ACO)

Purpose of an ACO

Responsibility for safety

ACO duties

ACO call sign

Information from SAR aircraft to the ACO

Transfer of ACO tasks

Checklists and guides

Designation of aircraft coordinator (ACO)

- When multiple aircraft conduct SAR operations, the SMC may designate an ACO in addition to an OSC.
- If this ~~is~~ not practicable, the OSC may designate an ACO.
- Generally, the ACO is responsible to the SMC and coordinates closely with the OSC.
- ~~Typically, the SMC or the OSC, as the case may be, would remain in overall charge.~~
- When deciding how much responsibility to delegate to the ACO, the SMC considers the mix of radios, radar, and trained personnel capabilities of the facilities involved.
- ~~Duties of the ACO may be carried out from a fixed-wing aircraft, a helicopter, a ship, a fixed structure such as an oil rig, or an appropriate land unit such as ATS unit or RCC.~~ The ACO function may be carried out from various locations, such as a fixed-wing aircraft, a helicopter, a ship, a fixed structure such as an oil rig, an ATS unit, a coordinating RCC or another appropriate land unit.
- Flight safety of SAR aircraft is a primary concern of the ACO.

Purpose of an ACO

The primary purpose of an ACO is to contribute to flight safety of aircraft involved in a SAR operation. The ACO ~~should~~ **must** have a clear understanding of the aim of ~~a~~ **the** SAR operation. The ACO organizes and coordinates the operations of aircraft involved ~~in the SAR mission~~ to carry out the mission effectively, paying particular attention to aircraft that are likely to operate close to each other.

Responsibility for safety

- **Information from ACOs to other aircraft on-scene is advisory**, but should nevertheless be followed as closely as practicable.
- If necessary to ensure flight safety, **aircraft pilots-in-command** should take whatever measures they assess are needed. If they decide to **aircraft pilots-in-command** deviate from advice passed by an ACO, or observe any potential hazard to flight operations, then they should inform the ACO as soon as possible.
- **The final decision concerning the safety of an aircraft, its crew and passengers rests with the pilots-in-command of the aircraft involved.**

ACO duties

~~Procedures, duties and tasks involving ACOs are described throughout this Section. A list of normal Duties for an ACO, also contained in IAMSAR Volume II, can include the following tasks:~~

- Contributing to flight safety:
 - maintain a safe flow of aircraft
 - ensure use of a common altimeter setting for all aircraft involved
 - advise the SMC/OSC of on-scene weather implications
 - determine a direction for entering and leaving an area of SAR action
 - determine all points necessary for maintaining safe flow in an area of SAR action
 - filter/manage radio messages to and from SAR aircraft
 - ensure frequencies are used in accordance with SMC directives
 - coordinate with adjacent air traffic services (ATS) ATS units.
- Prioritizing and allocating tasks:
 - ensure SAR aircraft are aware of the SMC/OSC overall plan and their own tasks
 - monitor and report search area coverage and/or rescue action
 - with appropriate SMC/OSC authority, identify emerging tasks and direct SAR aircraft to meet them.
- Coordinating aircraft operations:
 - respond to changing factors on scene and supervise effectiveness of operations
 - ensure the continuity of aircraft operations in coordination with SMC/OSC
 - monitor and keep SMC/OSC informed about the progress of tasks assigned to SAR aircraft
- Informing SAR aircraft:
 - assign tasks to aircraft
 - ~~distribute all relevant flight safety information to aircraft (reference sub paragraph Contributing to flight safety, above)~~
 - provide information about relevant air activity and dangers on-scene
 - provide information about search areas (if applicable), evacuation points (if applicable) and refuelling facilities
 - provide operational information about the ongoing SAR mission
 - provide relevant weather information.
- Make periodic situation reports (SITREPs) of SAR aircraft operations to the SMC and the OSC, as appropriate. The standard SITREP format may be found in appendix D.
- Work closely with the OSC:
 - assist in the execution of SMC directives
 - maintain communications
 - advise on how the ACO can assist.
- Coordinate aircraft refuelling.

ACO location

~~The ACO function may be carried out from various locations, such as a fixed-wing aircraft, a helicopter, a ship, a fixed structure such as an oil rig, an ATS unit, a coordinating RCC or another appropriate land unit. The procedures used should be similar regardless of the ACO location.~~

ACO call sign

In order to make the identity of an ACO clear to all participating units, the standard call sign "**Air Coordinator**" should be used by all ACOs.

Information from SAR aircraft to the ACO

In order to enhance situational awareness for ACOs and other SAR aircraft and to assist with safety and the continuity of operations, participating aircraft should report as follows:

- Entry report
- Reaching assigned points
- Leaving assigned points
- Commencing operations (search, investigation during search, approach to the surface/ship, ~~missed approach~~ difficulties, hoist, landing, etc.)
- Completing operations, including information regarding results
- Leaving present altitude
- Reaching new altitude
- 30 minutes on-scene endurance, expecting fuel at (location)
- 10 minutes to completing hoist operation
- 10 minutes to completing search
- Exit report

Transfer of ACO tasks

Before accepting the task the new ACO should understand the details of the SAR ~~mission~~ operation and the SMC's plans. The details required may include the aim of the operation, the position of the missing object, number of persons in distress, other units involved, locations of participating aircraft, communications and any limitations to the operation. When possible, basic pre-flight information should be provided by an SMC in order to simplify the transfer to the new ACO.

Checklists and guides

ACOs and SAR aircraft are recommended to use checklists or guides containing relevant information. Units who are likely to be designated as ACOs or take part as airborne SRUs in the event of a multiple aircraft SAR operation, should always have ACO checklists or guides available whenever they are on duty.

~~A short reference list~~ An operational summary known as the "Pilot Information File" (PIF) contains useful in-flight information useful for all aircraft involved in multiple aircraft operations. The PIF, guides and checklists suitable for ACOs and SAR aircraft are contained in appendix H-6.

Section 12 Searching

Section contents

General

Search action plan and message

Own search planning

Planning a search at sea

 Datum

 Visual search

 Sweep width, track spacing, and coverage

 Searching speed

 Search area

Search patterns

 Expanding square search

 Sector search

 Track line search

 Parallel track search

 Coordinated vessel / aircraft search pattern

Land search patterns

 Visual ground search

 Parallel track search

 Contour search

 Contour search (aircraft)

Initiation of search at sea

Restricted visibility

Look-outs

Radar search

Multiple aircraft search missions

 General

 Safety and search effectiveness

 Visual methods

 Flow methods

 Coordination zones

 No Fly zones

Further action on completion of initial phase
Navigational inaccuracies of searching vessels
Evidence of distressed craft found
Manoeuvring instructions
Search unsuccessful
Search successful

General

- For surface and aircraft facilities to search effectively, search patterns and procedures must be pre-planned so ships and aircraft can operate in coordinated operations with minimum risks and delay
- Standard search patterns have been established to meet varying circumstances.

Search action plan and message

- The SMC typically provides the search action plan.
- The OSC and ACO (if designated) and facilities on-scene implement the search action plan (see example message in appendix B).
- **The** search action plan message includes six parts.

Situation

- a brief description of the incident
- position of the incident, and time that it occurred
- number of persons on board (POB)
- primary and secondary search objects
- amount and types of survival equipment
- weather forecast and period of forecast
- SAR facilities on-scene

Search area(s) (presented in column format)

- area designation, size, corner points, centre point, and circle radius
- other essential data

Execution (presented in column format)

- SAR facility identification, parent agency, search pattern, creep direction, commence search points, and altitude

Coordination required

- designates the SMC, OSC and ACO
- SAR facility on-scene times
- desired track spacing and coverage factors

- OSC and ACO instructions (e.g. use of datum marker buoys)
- airspace reservations (e.g. danger area)
- aircraft safety instructions
- SAR facility change of operational coordination (SAR facility follows coordinating guidance of SMC, OSC and/or ACO)
- parent agency relief instructions
- authorizations for non-SAR aircraft in the area

Communications

- coordinating channels
- on-scene channels
- monitor channels
- method for OSC and/or ACO to be identified by SAR facilities
- press channels, if appropriate

Reports

- OSC reports of on-scene weather, progress, and other SITREP information, using standard SITREP format
 - parent agencies to provide summary at the end of daily operations (hours flown, area(s) searched, and coverage factor(s)).
- The OSC may be authorized by the SMC to alter the search action plan based on on-scene considerations and efforts achieved in previous searches.

Own search planning

- Normally the SMC will determine the search area by use of search planning tools at the RCC and in cooperation with the OSC.
- Considerations in developing a search plan include:
 - estimating the most probable position of a distressed craft or survivors, taking drift effect into consideration
 - determining the search area
 - selecting SAR facilities and equipment to be used
 - selecting a search pattern
 - planning on-scene coordination.

~~Section 3 provides specific search planning guidance.~~

Planning the search at sea

Datum

- It will be necessary to establish a datum, or geographic reference, for the area to be searched. The following factors should be considered:

- reported position and time of the SAR incident
- any supplementary information such as DF bearings or sightings
- time interval between the incident and the arrival of SAR facilities
- estimated surface movements of the distressed craft or survival craft, depending on drift. (The two figures following this discussion are used in calculating drift.)
- The datum position for the search is found as follows:
 - drift has two components: leeway and total water current
 - leeway direction is downwind
 - leeway speed depends on wind speed
 - the observed wind speed when approaching the scene may be used for estimating leeway speed of liferafts by using the graph following this discussion. (Persons in the water (PIW) have no leeway while liferaft stability and speed vary with or without drogue or ballast.)
 - total water current may be estimated by using the computed set and drift of vessels at or near the scene
 - drift direction and speed is the vector sum of leeway and total water current
- drift distance is drift speed multiplied by the time interval between the incident time, or time of the last computed datum, and the commence search time
- datum position is found by moving from the incident position, or last computed datum position, the drift distance in the drift direction and plotting the resulting position on a suitable chart.

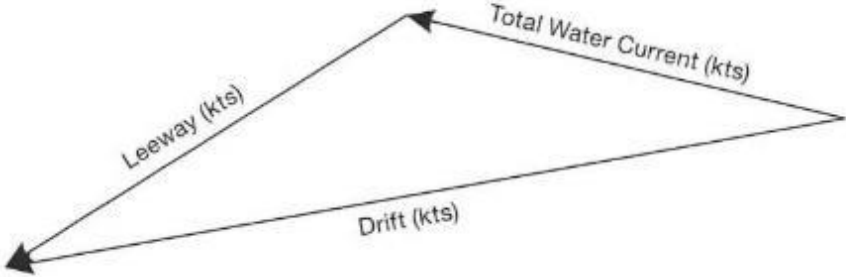

Computing drift speed and direction from total water current and leeway

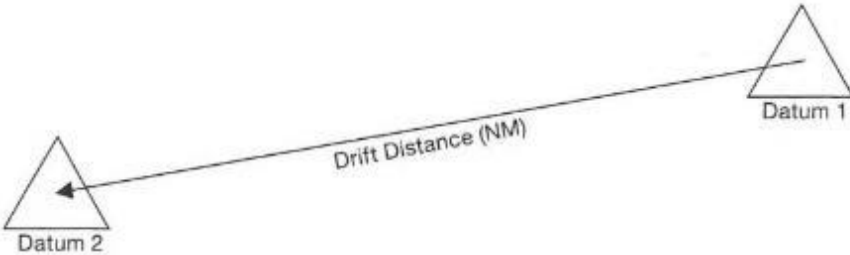

*Determining a new datum
(drift distance = drift speed × drift time)*

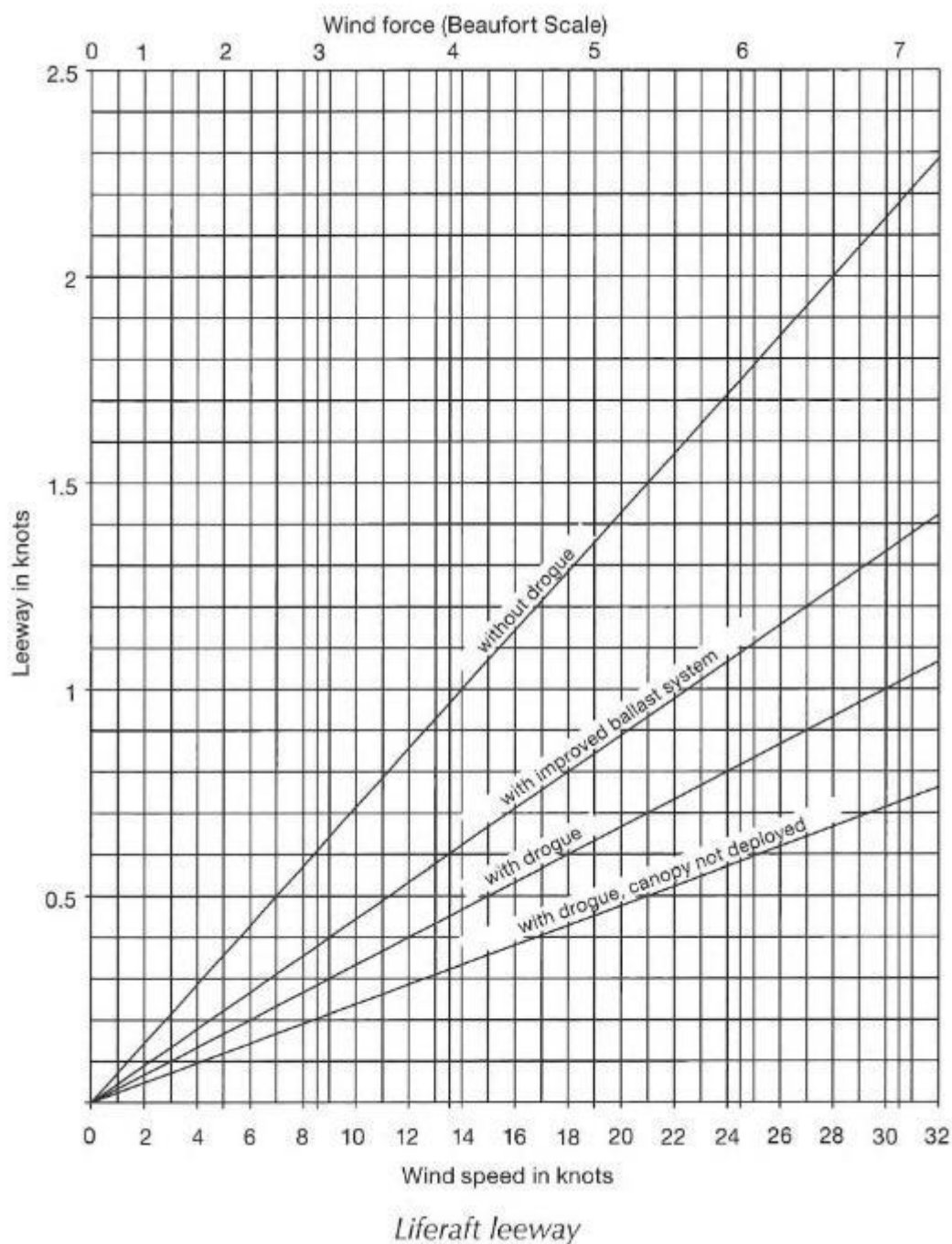

Visual search

- Individual search patterns have been designed so that an OSC can rapidly initiate a search by one or more craft.
- There will be a number of variables that cannot be foreseen. Search patterns based on visual search have been established which should meet many circumstances. They have been selected for simplicity and effectiveness and are discussed later in this section.

Sweep width, track spacing, and coverage

- *Sweep width (W)* is an index or measure of the ease or difficulty of detecting a given search object with a given sensor under a given set of environmental conditions. Tables of "uncorrected" sweep width values based on search object and meteorological visibility for calm weather, and correction factors based on search object and weather conditions (*fw*) are provided following this discussion. Multiplying the uncorrected sweep width value (*WU*) by the appropriate weather correction factor produces the corrected sweep width (*WC*):

$$WC = WU \times fw$$

- Most search patterns consist of straight, parallel, equally spaced tracks covering a rectangular area. The distance between adjacent tracks is called the track spacing (*S*).
- *Coverage (C)* is the ratio of the corrected sweep width (*WC*) to the track spacing (*S*):

$$C = WC/S$$

- The recommended coverage (*C*) for most situations is 1.0, which means the recommended track spacing (*S*) in most situations is the same as the corrected sweep width (*WC*):

$$\text{Recommended } S = WC$$

- Changes in weather, number of assisting craft, etc., may occur, making it prudent to alter the track spacing (~~*S*~~).
- All searching ships and aircraft should maintain safe distances from one another and accurately follow their assigned search patterns.
- In addition to the weather correction factors (~~*fw*~~), other factors may be considered, such as time of day, position of the sun, effectiveness of observers, etc.

**Uncorrected sweep widths (W_U) for
merchant vessels (km (NM))**

Search object	Meteorological visibility (km (NM))				
	6 (3)	9 (5)	19 (10)	28 (15)	37 (20)
Person in water	0.7 (0.4)	0.9 (0.5)	1.1 (0.6)	1.3 (0.7)	1.3 (0.7)
4-person liferaft	4.2 (2.3)	5.9 (3.2)	7.8 (4.2)	9.1 (4.9)	10.2 (5.5)
6-person liferaft	4.6 (2.5)	6.7 (3.6)	9.3 (5.0)	11.5 (6.2)	12.8 (6.9)
15-person liferaft	4.8 (2.6)	7.4 (4.0)	9.4 (5.1)	11.9 (6.4)	13.5 (7.3)
25-person liferaft	5.0 (2.7)	7.8 (4.2)	9.6 (5.2)	12.0 (6.5)	13.9 (7.5)
Boat < 5 m (17 ft)	2.0 (1.1)	2.6 (1.4)	3.5 (1.9)	3.9 (2.1)	4.3 (2.3)
Boat 7 m (23 ft)	3.7 (2.0)	5.4 (2.9)	8.0 (4.3)	9.6 (5.2)	10.7 (5.8)
Boat 12 m (40 ft)	5.2 (2.8)	8.3 (4.5)	14.1 (7.6)	17.4 (9.4)	21.5 (11.6)
Boat 24 m (79 ft)	5.9 (3.2)	10.4 (5.6)	19.8 (10.7)	27.2 (14.7)	33.5 (18.1)

**Uncorrected sweep widths (W_U) for
helicopters (km (NM))**

Search object	Meteorological visibility (km (NM))		
	1.9 (1)	9.3 (5)	> 37 (> 20)
Person in water	0.0 (0.0)	0.2 (0.1)	0.2 (0.1)
4-person liferaft	0.9 (0.5)	3.1 (1.7)	5.4 (2.9)
8-person liferaft	0.9 (0.5)	3.9 (2.1)	7.0 (3.8)
15-person liferaft	1.1 (0.6)	4.4 (2.4)	8.3 (4.5)
25-person liferaft	1.1 (0.6)	5.2 (2.8)	10.6 (5.7)
Boat < 5 m (17 ft)	0.9 (0.5)	3.0 (1.6)	4.6 (2.5)
Boat 6 m (20 ft)	1.3 (0.7)	5.6 (3.0)	10.9 (5.9)
Boat 10 m (33 ft)	1.3 (0.7)	7.2 (3.9)	16.9 (9.1)
Boat 24 m (80 ft)	1.5 (0.8)	10.6 (5.7)	34.3 (18.5)

**Uncorrected sweep widths (W_U) for
fixed-wing aircraft (km (NM))**

Search object	Meteorological visibility (km (NM))		
	1.9 (1)	9.3 (5)	> 37 (> 20)
Person in water	0.0 (0.0)	0.2 (0.1)	0.2 (0.1)
4-person liferaft	0.6 (0.3)	2.4 (1.3)	4.3 (2.3)
8-person liferaft	0.7 (0.4)	3.1 (1.7)	5.6 (3.0)
15-person liferaft	0.7 (0.4)	3.7 (2.0)	6.9 (3.7)
25-person liferaft	0.7 (0.4)	4.3 (2.3)	8.7 (4.7)
Boat < 5 m (17 ft)	0.7 (0.4)	2.4 (1.3)	3.7 (2.0)
Boat 6 m (20 ft)	0.9 (0.5)	4.6 (2.5)	9.3 (5.0)
Boat 10 m (33 ft)	0.9 (0.5)	6.3 (3.4)	14.4 (7.8)
Boat 24 m (80 ft)	1.1 (0.6)	9.4 (5.1)	30.9 (16.7)

Weather correction factors (f_w) for all types of search units

Weather Winds km/h (kts) or seas m (ft)	Search object	
	Person in water	Liferaft
Winds 0–28 km/h (0–15 kt) or seas 0–1 m (0–3 ft)	1.0	1.0
Winds 28–46 km/h (15–25 kt) or seas 1–1.5 m (3–5 ft)	0.5	0.9
Winds > 46 km/h (> 25 kt) or seas > 1.5 m (> 5 ft)	0.25	0.6

Searching speed (V)

- To perform a parallel track search with several vessels moving together in a coordinated manner, all vessels should proceed at the same speed, as directed by the OSC.
- When performing a coordinated search with several vessels moving together, the search speed should normally be the maximum speed of the slowest vessel present under the prevailing conditions.
- In restricted visibility, the OSC will normally order a reduction in searching speed.

Search area (*A*)

- Compute the search radius (*R*), using one of the following two methods:
- if the search must commence immediately, assume $R = 10 \text{ NM}$
- if time is available for computation:

- compute the area a craft can cover in a certain amount of time (*T*) by the formula:

$$A = S \times V \times T$$

- the total amount of area (*A_t*) which can be covered by several craft is the sum of the areas each craft can cover:

$$A_t = A_1 + A_2 + A_3 + \dots$$

- if all craft are searching at the same speed for the same amount of time, then:

$$A_t = N \times A$$

where *N* is the number of search craft

- the search radius (*R*) of the circle is one-half the square root of the search area:

$$R = \frac{\sqrt{A_t}}{2}$$

- Plot the search area:
 - draw a circle centred on datum with radius *R*
 - using tangents to the circle, form a square as shown below
 - if several facilities will be searching at the same time, divide the square into sub-areas of the appropriate size and assign search facilities accordingly.

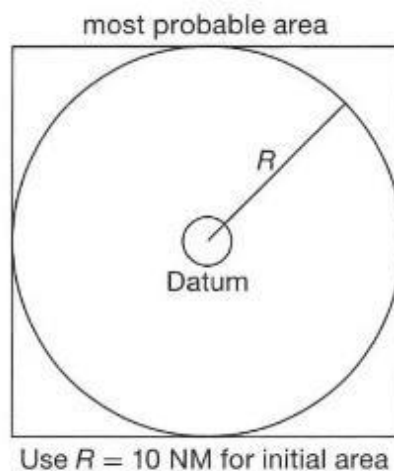

Search patterns

- Factors to consider in deciding what type of search pattern to use include:
 - available number and types of assisting craft
 - size of area to be searched
 - type of distressed craft
 - size of distressed craft
 - meteorological visibility
 - cloud ceiling
 - type of sea conditions
 - time of day
 - arrival time at datum.

~~Section 3 provides specific information on search patterns.~~

- It may be advisable for vessels, especially when searching for a person in the water with either an expanding square search (SS) or a sector search (VS), to use dead reckoning (DR) navigation rather than more accurate navigational methods. DR navigation will minimize pattern distortion relative to the search object since it will automatically account for the currents affecting the search object's drift during the search.
- For both vessels and aircraft, if a datum marker buoy or a smoke float or other highly visible-object is available, it should be deployed at datum and the pattern should be performed relative to it.
- Precise search pattern navigation using high-precision methods such as global satellite navigation systems will produce good patterns relative to the ocean bottom, but not relative to the drifting search object. This could allow the search object to drift out of the search area before the search facility arrives in that vicinity.

Expanding square search (SS)

- Most effective when the location of the search object is known within relatively close limits.
- The commence search point is always the datum position.
- Often appropriate for vessels or small boats to use when searching for persons in the water or other search objects with little or no leeway.
- Due to the small area involved, this procedure must not be used simultaneously by multiple aircraft at similar altitudes or by multiple vessels.
- Accurate navigation is required; the first leg is usually oriented directly into the wind to minimize navigational errors.
- It is difficult for fixed-wing aircraft to fly legs close to datum if S is less than 2 NM.

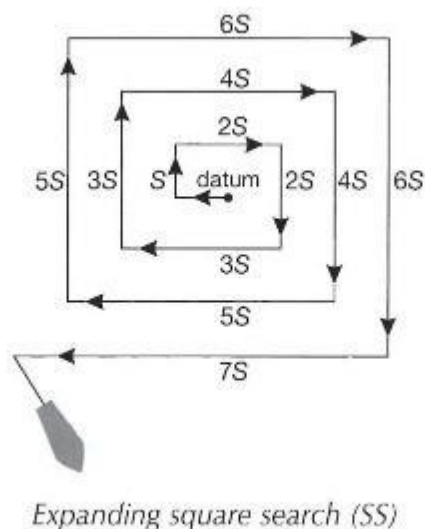

Sector search (VS)

- Most effective when the position of the search object is accurately known and the search area is small.
- Used to search a circular area centred on a datum point.
- Due to the small area involved, this procedure must not be used simultaneously by multiple aircraft at similar altitudes or by multiple vessels.
- An aircraft and a vessel may be used together to perform independent sector searches of the same area.
- A suitable marker (for example, a smoke float or a radio beacon) may be dropped at the datum position and used as a reference or navigational aid marking the centre of the pattern.
- For aircraft, the search pattern radius is usually between 5 NM and 20 NM.
- For vessels, the search pattern radius is usually between 2 NM and 5 NM, and each turn is 120°, normally turned to starboard.

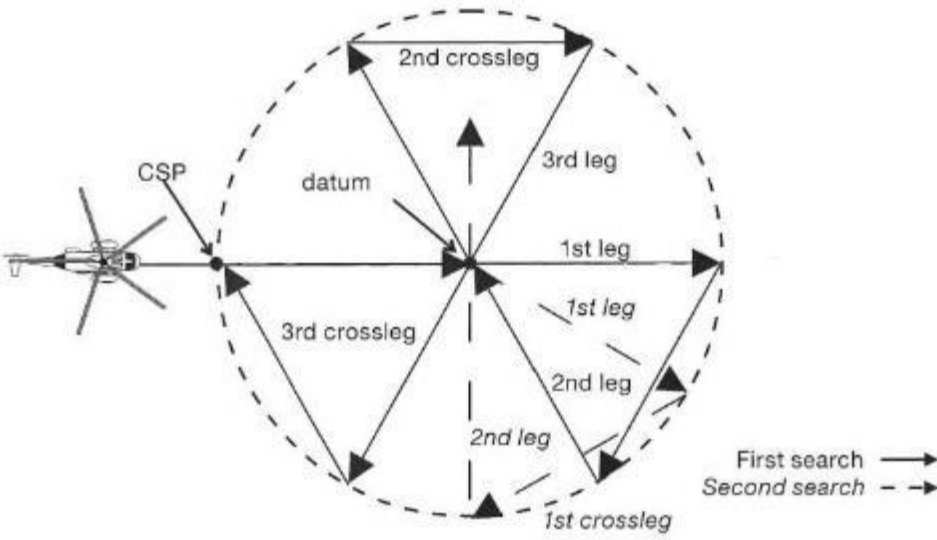

Sector pattern: single-unit (VS)

**Sector search computations: time to complete one leg (t)
in minutes and seconds**

Radius	Speed								
	3 kt	5 kt	8 kt	10 kt	15 kt	20 kt	60 kt	80 kt	90 kt
0.5 NM	10:00	6:00	3:45	3:00	2:00	1:30	0:30	0:22.5	0:20
1.0 NM	20:00	12:00	7:30	6:00	4:00	3:00	1:00	0:45	0:40
1.5 NM	30:00	18:00	11:15	9:00	6:00	4:30	1:30	1:07.5	1:00
2.0 NM	40:00	24:00	15:00	12:00	8:00	6:00	2:00	1:30	1:20
2.5 NM	50:00	30:00	18:45	15:00	10:00	7:30	2:30	1:55.5	1:40
3.0 NM	60:00	36:00	22:30	18:00	12:00	9:00	3:00	2:18	2:00
3.5 NM		42:00	26:15	21:00	14:00	10:30	3:30	2:40.5	2:20
4.0 NM		48:00	30:00	24:00	16:00	12:00	4:00	3:03	2:40
4.5 NM		54:00	33:45	27:00	18:00	13:30	4:30	3:25.5	3:00
5.0 NM		60:00	37:30	30:00	20:00	15:00	5:00	3:48	3:20
6.0 NM			45:00	36:00	24:00	18:00	6:00	4:33	4:00
7.0 NM			52:30	42:00	28:00	21:00	7:00	5:18	4:40
8.0 NM			60:00	48:00	32:00	24:00	8:00	6:03	5:20

Note: Interpolation may be used with this table.

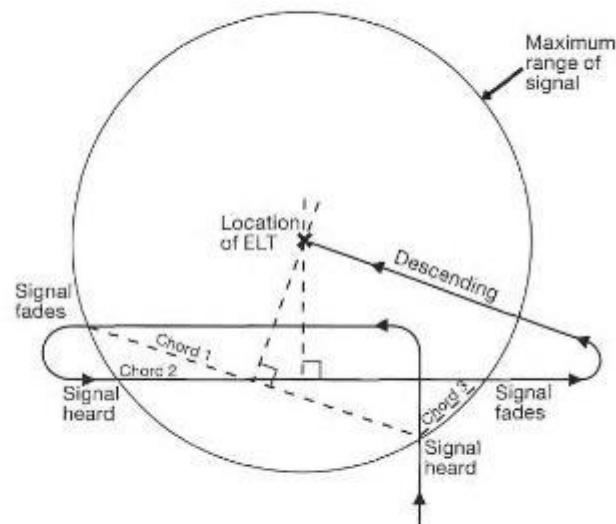

Map-assisted aural electronic search

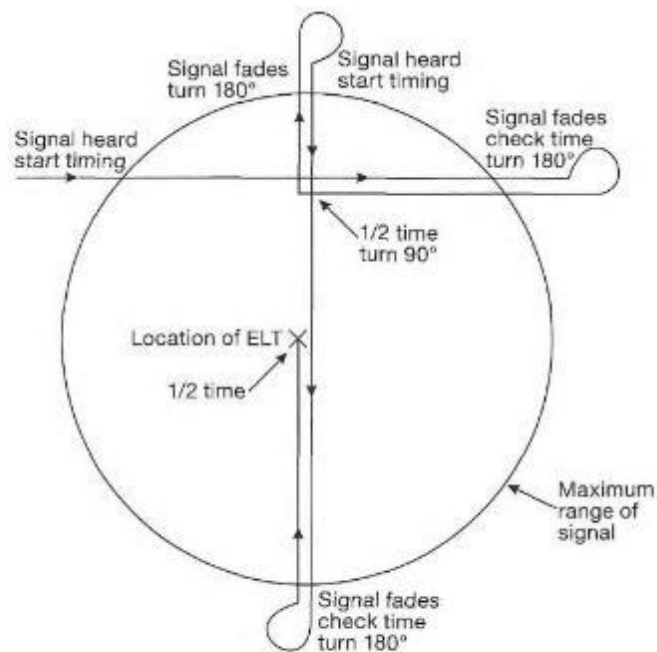

Time-assisted aural electronic search

Uncorrected sweep widths (W_U) for visual land search (km (NM))

Search object	Height (m (ft))	Visibility (km (NM))				
		6 (3)	9 (5)	19 (10)	28 (15)	37 (20)
Person	150 (500)	0.7 (0.4)	0.7 (0.4)	0.9 (0.5)	0.9 (0.5)	0.9 (0.5)
	300 (1,000)	0.7 (0.4)	0.7 (0.4)	0.9 (0.5)	0.9 (0.5)	0.9 (0.5)
	450 (1,500)	—	—	—	—	—
	600 (2,000)	—	—	—	—	—
Vehicle	150 (500)	1.7 (0.9)	2.4 (1.3)	2.4 (1.3)	2.4 (1.3)	2.4 (1.3)
	300 (1,000)	1.9 (1.0)	2.6 (1.4)	2.6 (1.4)	2.8 (1.5)	2.8 (1.5)
	450 (1,500)	1.9 (1.0)	2.6 (1.4)	3.1 (1.7)	3.1 (1.7)	3.1 (1.7)
	600 (2,000)	1.9 (1.0)	2.8 (1.5)	3.7 (2.0)	3.7 (2.0)	3.7 (2.0)
Aircraft less than 5,700 kg	150 (500)	1.9 (1.0)	2.6 (1.4)	2.6 (1.4)	2.6 (1.4)	2.6 (1.4)
	300 (1,000)	1.9 (1.0)	2.8 (1.5)	2.8 (1.5)	3.0 (1.6)	3.0 (1.6)
	450 (1,500)	1.9 (1.0)	2.8 (1.5)	3.3 (1.8)	3.3 (1.8)	3.3 (1.8)
	600 (2,000)	1.9 (1.0)	3.0 (1.6)	3.7 (2.0)	3.7 (2.0)	3.7 (2.0)
Aircraft over 5,700 kg	150 (500)	2.2 (1.2)	3.7 (2.0)	4.1 (2.2)	4.1 (2.2)	4.1 (2.2)
	300 (1,000)	3.3 (1.8)	5.0 (2.7)	5.6 (3.0)	5.6 (3.0)	5.6 (3.0)
	450 (1,500)	3.7 (2.0)	5.2 (2.8)	5.9 (3.2)	5.9 (3.2)	5.9 (3.2)
	600 (2,000)	4.1 (2.2)	5.2 (2.9)	6.5 (3.5)	6.5 (3.5)	6.5 (3.5)

Correction factors – vegetation and high terrain

Search object	15–60% vegetation or hilly	60–85% vegetation or mountainous	Over 85% vegetation
Person	0.5	0.3	0.1
Vehicle	0.7	0.4	0.1
Aircraft less than 5,700 kg	0.7	0.4	0.1
Aircraft over 5,700 kg	0.8	0.4	0.1

Track line search (TS)

- Normally used when an aircraft or vessel has disappeared without a trace along a known route.
- Often used as initial search effort due to ease of planning and implementation.
- Consists of a rapid and reasonably thorough search along intended route of the distressed craft.
- Search may be along one side of the track line and return in the opposite direction on the other side (TSR).
- Search may be along the intended track and once on each side, then search facility continues on its way and does not return (TSN).
- Aircraft are frequently used for TS due to their high speed.
- Aircraft search height usually 300 m to 600 m (1,000 ft to 3,000 ft) during daylight or 600 m to 900 m (2,000 ft to 3,000 ft) at night.

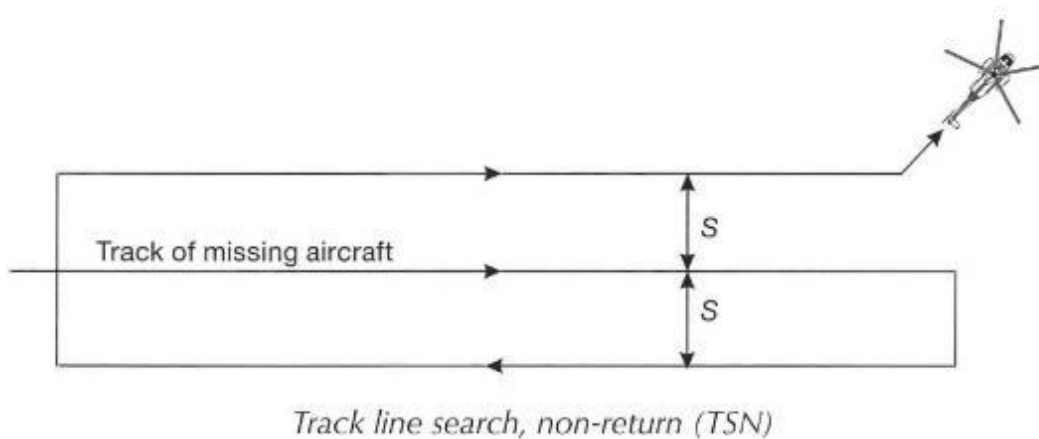
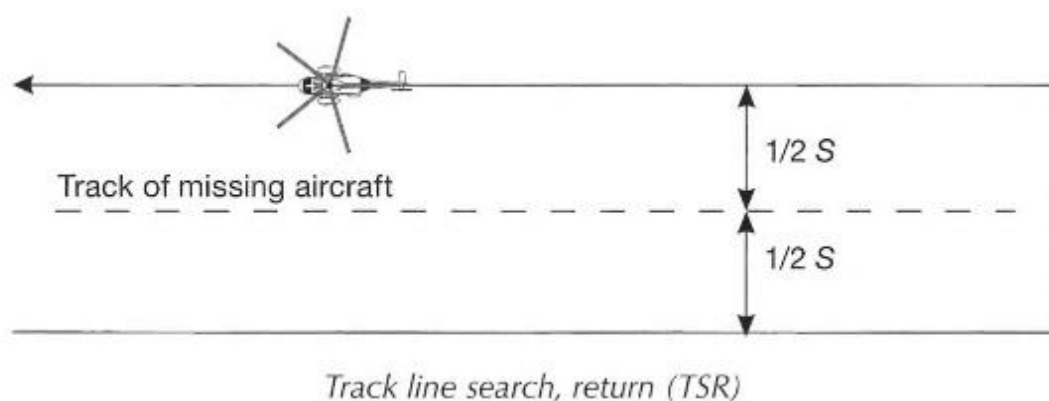

Parallel track search (PS)

- Used to search a large area when survivor location is uncertain.
- Most effective over water or flat terrain.
- Usually used when a large search area must be divided into sub-areas for assignment to individual search facilities on-scene at the same time.
- The commence search point is in one corner of the sub-area, one-half track space inside the rectangle from each of the two sides forming the corner.
- Search legs are parallel to each other and to the long sides of the sub-area.
- Multiple vessels may be used as shown **below**. on page 3-30:
 - Parallel track search: for use by two ships.
 - Parallel track search: for use by three ships.
 - Parallel track search: for use by four ships.
 - Parallel track search: for use by five or more ships

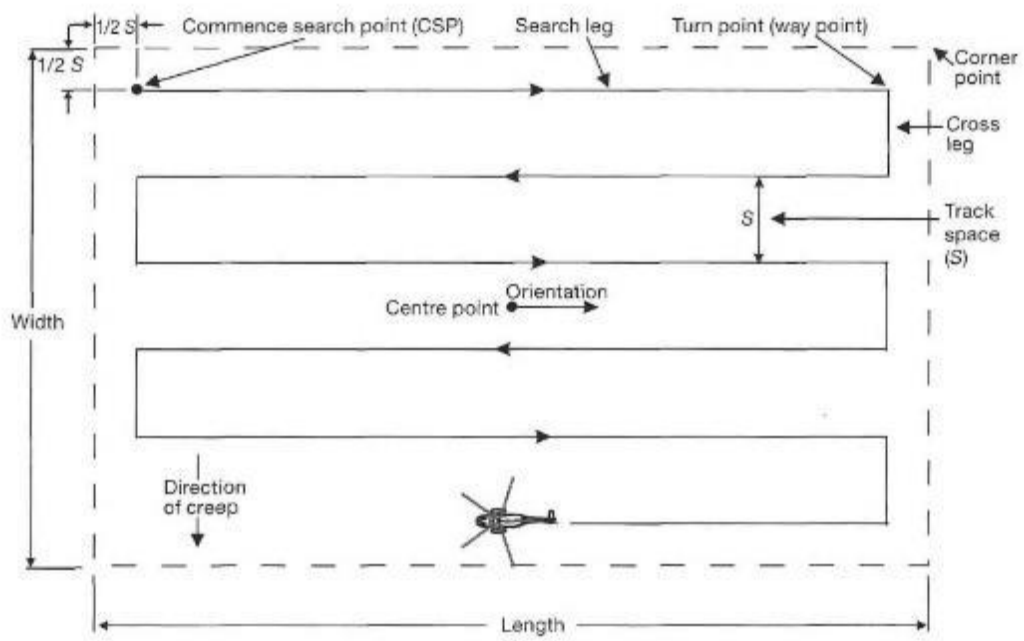

Parallel track search (PS)

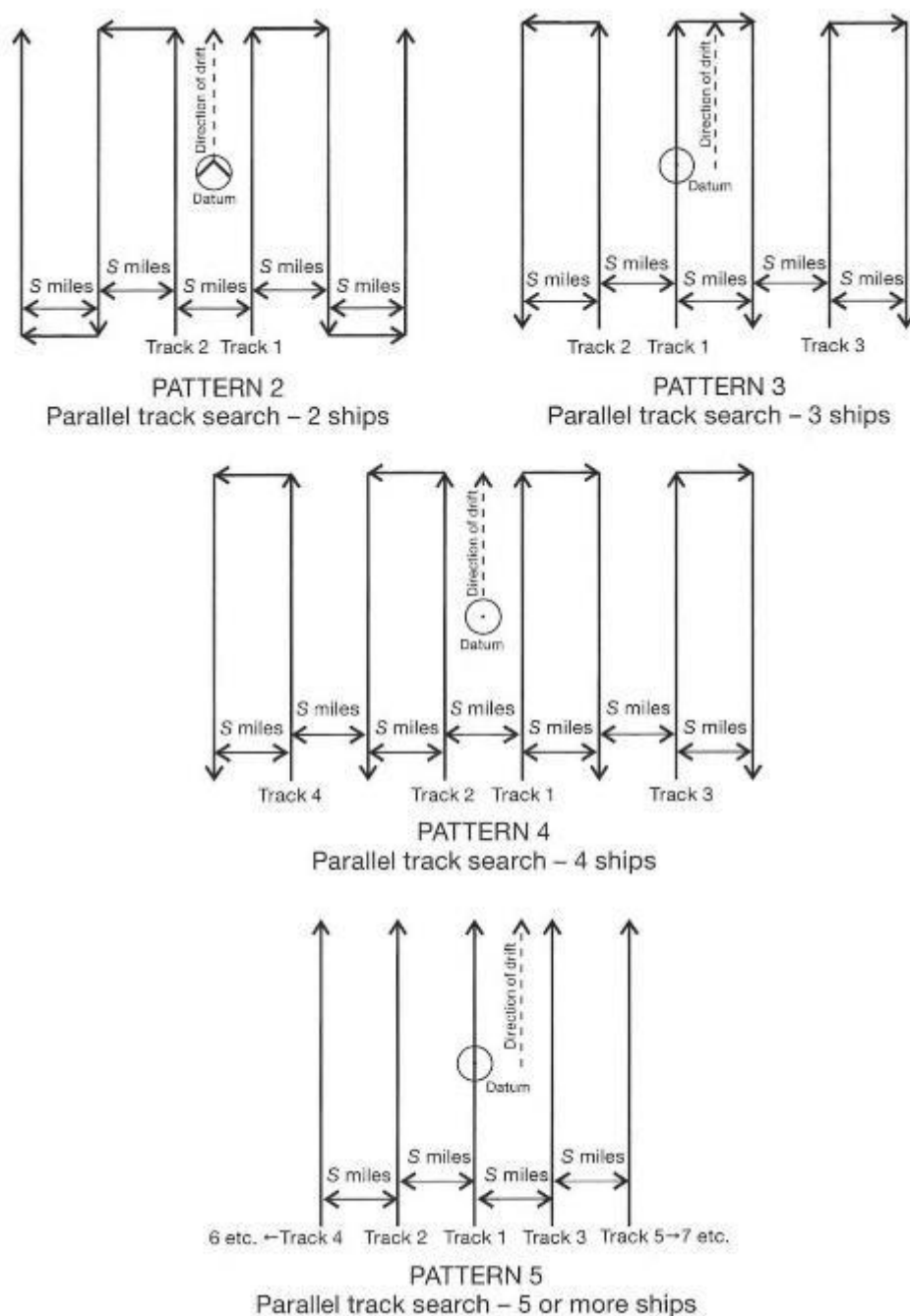

Coordinated vessel–aircraft search pattern

- Normally used only if there is an OSC present to give direction to and provide communications with the participating craft.
- Creeping line search, coordinated (CSC) is often used as an alternative name.
- The aircraft does most of the searching, while the ship steams along a course at a speed as directed by the OSC so that the aircraft can use it as a navigational checkpoint.

- The aircraft, as it passes over the ship, can easily make corrections to stay on the track of its search pattern.
- Gives a higher probability of detection than can normally be attained by an aircraft searching alone.
- Ship speed varies according to the speed of the aircraft and the size of the pattern. The relationship among the speed of the surface facility, the aircraft's speed, the track spacing and the length of the search legs is defined by the following equation:

$$V_s = (S \times V_a) / (L + S)$$

where V_s is the speed of the surface facility in knots, S is the track spacing in nautical miles, V_a is the aircraft's true air speed (TAS) in knots, and L is the length of the aircraft's search leg in nautical miles.

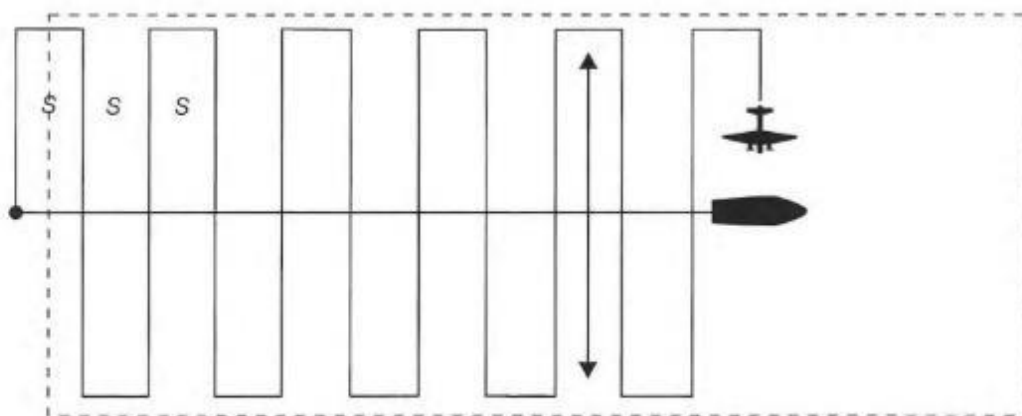

Creeping line search, coordinated (CSC)

Land search patterns

- Aircraft search over land differs from maritime searching in that it is usually more difficult to locate search objects.
- Repeated aircraft searches of an area are often necessary.
- Search of large areas by ground facilities alone is usually not practical but may be effective for close examination of a small area.

Visual ground search

- Use obvious natural or artificial landmarks such as rivers or roads to delimit search sub-areas.
- Land search facilities should be equipped with large-scale topographical maps with search areas marked on them.

- Land search facility patterns are normally parallel tracks or contour searches using a line-abreast formation.
- Track spacing for lost persons is normally between five and eight metres.
- Search progress should be slow through wooded areas. One square kilometre of woods can be searched by 20 to 25 persons in about 1.5 hours.

~~The P-~~Land parallel track search

- team leader, two flankers on end of each line, and as many searchers as the terrain will allow
- search line is first formed along the search area boundary
- if an obstacle or an item of interest is encountered, the team stops and waits for results of the investigation before the entire search line moves forward again
- boundary control of each successive pass through an area is assigned to the pivoting flanker
- track spacing between each searcher is determined by the distance a person can effectively search while keeping adjacent searchers in visual and audible contact
- on first leg of search, one flanker will follow a natural boundary or predetermined compass course while the other flanker marks a trail at the other end to follow after the pivot is made
- if contact is lost with a searcher, the team leader must be notified and the search line stopped until complete team contact is re-established.

~~The Contour search~~

- used when mountainous features can be circled completely
- pattern is a modified parallel track
- search begins with one flanker at the highest level and the other flanker at the low end of the line
- when the mountain is circled once, the search line is re-formed on the lower side of the bottom flanker
- general procedures for a parallel track search are followed.

Contour search (OS – aircraft)

- Used around mountains and in valleys when sharp changes in elevation make other patterns not practical.
- Search is started from highest peak and goes from top to bottom with new search altitude for each circuit.

- Search altitude intervals may be 150 m to 300 m (500 ft to 1,000 ft).
- The aircraft may make a descending orbit away from the mountain before resuming the contour search at the lower altitude.
- The aircraft may spiral downwards around the mountain at a low but approximately constant rate of descent when there is not enough room to make a circuit opposite to the direction of search.
- If the mountain cannot be circled, successive sweeps at the same altitude intervals as listed above should be flown along its side.
- Valleys are searched in circles, moving the centre of the circuit one track spacing after each completed circuit.

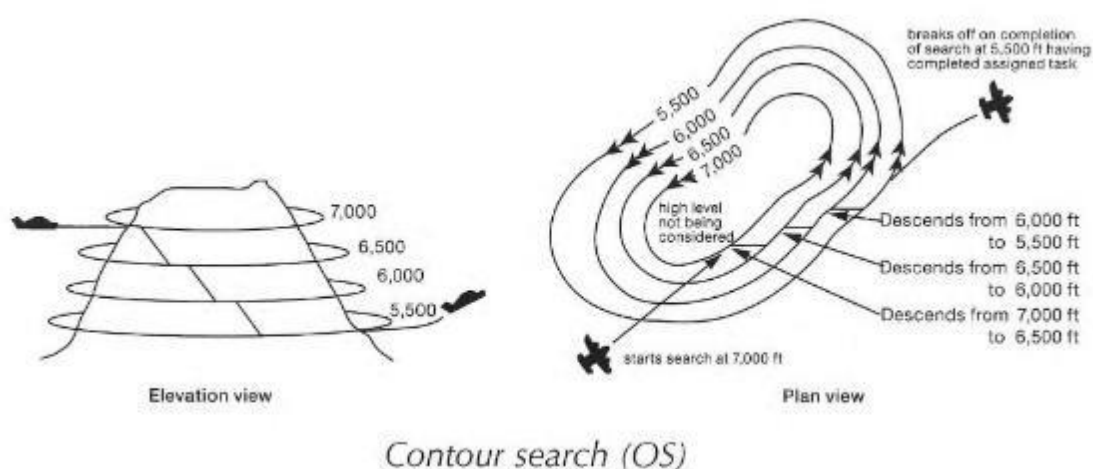

Initiation of search at sea

- When a search facility arrives on-scene in advance of the others, it should proceed directly to datum and commence an expanding square search.
- If possible, datum may be marked by putting over a liferaft or other floating marker with a leeway similar to that of the search object, as a check on the drift.
- This can then be used as a datum marker throughout the search.
- As other facilities arrive, the OSC should select one of the search patterns, as appropriate, and allocate search sub-areas to individual facilities.
- In good visibility and with sufficient search facilities, the OSC may let the first facility continue its expanding square search while the others conduct a parallel track search through the same area.
- In restricted visibility, or if sufficient search facilities are not available, it will probably be better to have the first facility break off the expanding square search and be available for initiation of a parallel track search.

Restricted visibility

- A parallel track search in restricted visibility poses problems because of the following considerations:
 - desirability of reducing the interval between SAR facilities as much as possible consistent with safety
 - resulting loss of search area coverage
 - potential risk of collision.
- During restricted visibility, the OSC should direct a reduction of vessel speed as necessary.
- In such circumstances, any ship not fitted with radar, or whose radar has become defective, should consider dropping astern of other ships, informing the OSC of its action.
 - the ship's search should continue when it judges its position (relative to other searching ships) is safe to do so
 - if there is a reduction in visibility and ships have already started to carry out a search pattern, the OSC may decide that the safest action would be to continue the pattern in force despite the resulting loss of coverage.
- Should it be necessary for the OSC to consider initiating any of the patterns during conditions of restricted visibility, the following factors should be considered:
 - ships will be proceeding at a reduced speed and searches will take longer
 - to search the area thoroughly in such conditions must mean a reduction in track spacing
 - reduction in track spacing would require a reduction in the interval between SAR facilities and, thus, the carrying out of more tracks.
- The OSC may decide to accept a reduction in the area searched and should have regard to the direction and rate of estimated drift in deciding whether to accept a reduction in one or both of the length and width of the search area.
- If visibility improves, the OSC should initiate such actions as will best make good the lost coverage which has taken place.

Look-outs

- Look-outs, also referred to as observers or scanners, are very important for effective searches. Their location on the search facility, scanning technique, and concentration on searching should be of concern to the search facility. They should report any object or noise.
- Aircraft observers must concentrate visual scans within the distance of the track spacing.
- Vessels:

Day

- Place look-outs high on the vessel.

Night

- Place look-outs on the bows as far forward and as low to the water's edge as possible to hear any calls for help and to establish the best night vision.
- Appendix C provides advice for all look-outs. Factors affecting observer effectiveness include:
 - weather conditions and visibility
 - type of search craft (vessel, aircraft, liferaft, or person)
 - state of the sea (calm, choppy, or rough)
 - land features (woods, desert, jungle)
 - daytime or night-time
 - look-out fatigue.

Radar search

- When several assisting ships are available, a radar search may be effective, especially when the position of the incident is not known reliably and SAR aircraft may not be available.
- No prescribed pattern has been provided for this contingency.
- The OSC should normally direct ships to proceed in "loose line abreast", maintaining a track spacing between ships of the expected detection range multiplied by 1.5.
- The table below serves as a guide for detection ranges for ship radar.

Search object	Radar scanner height	
	15 m	30 m
10,000 gt ship	13.0 NM	18.0 NM
1,000 gt ship	6.0 NM	8.4 NM
200 gt ship	5.5 NM	7.7 NM
9 m boat	1.9 NM	2.7 NM

Multiple aircraft search missions

General

~~Factors relevant to search operations are described in IAMSAR Volume II, chapters 4 and 5.~~

- The most likely situations in which multiple aircraft might be involved in searches is when large areas need to be searched in which the confidence of the datum position is low.
- The procedures described below generally assume that visual search techniques are used. However, other technical devices and/or techniques such as radar or FLIR searches might also be required or SAR aircraft might only be able to locate persons in distress by homing onto transmissions from emergency distress beacons, transponders or other devices. In these situations, techniques might have to be modified and the need for multiple SAR aircraft might have to be considered carefully.

Safety and search effectiveness

- ~~ACO and SAR aircraft should use p~~ Procedures that ensure flight safety without making the search ineffective should be used. Aircraft should be given sufficient operational freedom to carry out their searches effectively, but should conform to safety procedures briefed by the RCC, ACO, OSC or ATS. ~~The ACO should encourage a~~ A high degree of situational awareness amongst the aircraft should always be encouraged.
- Methods used to safely keep aircraft apart will depend on the on-scene conditions. Beginning with good weather conditions and progressing to poor conditions, methods for keeping aircraft apart to enhance flight safety are ~~can~~ be as follows:
 - Visual methods
 - Flow methods
 - Coordination zones
 - No fly zones

Visual methods

- Visual methods involve the ~~ACO allocating~~ allocation of aircraft to search areas and aircraft avoiding each other visually. Visual methods may be the only measure necessary when weather conditions on-scene are good.
- When using visual methods, the RCC, ACO or OSC can allow aircraft more freedom of action compared to other, more restrictive, methods. However, this freedom will not relieve the need to operate with due regard to other flight information and reporting requirements. ~~aircraft or ACOs from other duties outlined earlier in this section, for example providing information on air activity or making aircraft reports.~~

Flow methods

- Flow methods can be used to assist keeping SAR aircraft apart in slightly poorer conditions, by ensuring that they fly the same search patterns (commence search point / ~~line of advance~~ direction of creep, etc.) but in relative to adjacent search areas.
- The first aircraft on scene should be allocated the search area furthest away from the direction of creep LOA. This method generally enables aircraft to execute effective searches of areas with a minimum of radio communication. All aircraft should still be very well informed of each other to avoid any conflicts, particularly for small track spacings and with high performance aircraft turning circles at high speeds before rejoining search legs.

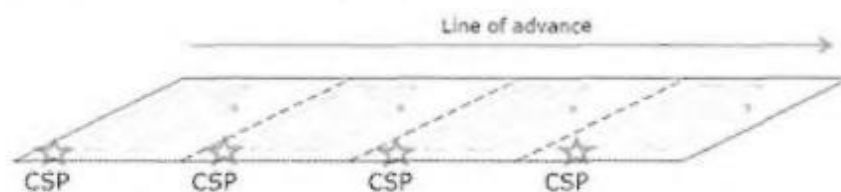

- ~~The ACO may order s~~ Specific search altitudes may be assigned for SRUs, to allow an extra margin of safety when aircraft operate in close proximity to each other.
- However, in this situation ~~the ACO should be aware that any limit to the operational freedom of an aircraft, particularly in altitude, could reduce the effectiveness of the search~~ may be compromised.
- ~~The ACO should also expect~~ An additional consideration is that aircraft may need to deviate from their assigned altitudes if they need to investigate objects on the surface or drop SAR supplies.
- **ACOs should ensure that all All aircraft should use the same reference for altitude.**
 - Amend diagram as follows: Replace the legend "Line of advance" with "Direction of creep"

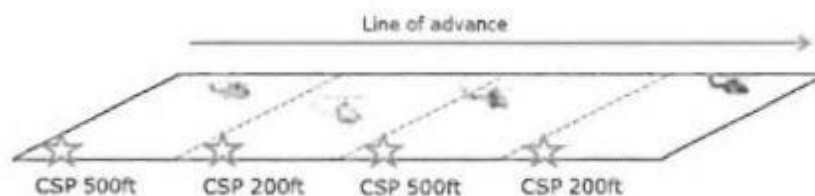

Coordination zones

- Coordination zones are border areas established by an ACO between adjacent search areas, which SAR aircraft can only enter under specific conditions. Coordination zones enable aircraft to have operational flexibility within their allocated search areas and ensure a level of safety between them.

- The dimensions of a coordination zone depend on the on-scene conditions and the size of a search area. As a general guide a coordination zone might be 2 nautical miles across, but this size may be increased or decreased if needed.
- Allowance for aircraft turns at the end of search legs needs to be considered, especially for high speed aircraft.
- Before entering a coordination zone, aircraft sharing the zone communicate with each other in order to safely coordinate the entry. The aircraft should call again when leaving the zone.
- The ACO, OSC or RCC should ensure that the aircraft have a clear understanding of their mutual operating areas.

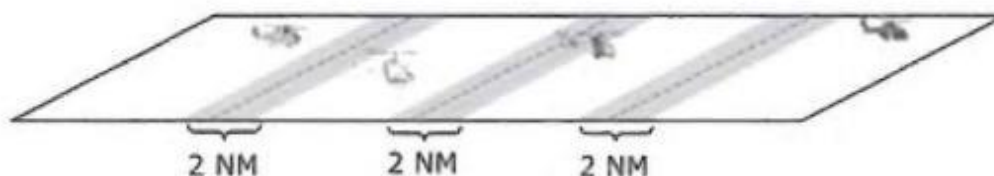

No fly zones

- If on-scene conditions are sufficiently difficult, no fly zones can be used in which flight is not permitted while searching is taking place in adjacent areas. The dimensions of no fly zones can be similar to coordination zones.
- Whenever no fly zones are used, the ACO should coordinate with the SMC and OSC to ensure that the no fly zones are searched appropriately during the SAR mission operation.



Further action on completion of initial phase

- The initial phase is normally considered to have been completed when, in the absence of further information, searching ships have completed one search of the most probable area.
- If at that stage nothing has been located, it will be necessary for the SMC, in consultation with the OSC, to consider the most effective method of continuing the search.
- Failure to locate the search object may be due to one or more of the following causes:
 - Errors in position owing to navigational inaccuracies or inaccuracy in the distress communications reporting the position. This is especially likely to apply if the position of datum was based on an estimated position using incomplete information.

- An error in drift estimation.
- Failure to sight the search object during the search although it was in the search area. This is most likely to occur if the search object is a small craft, a survival craft, survivors in the water, a light aircraft forced down in rough or densely vegetated terrain, or survivors in rough or densely vegetated terrain. In the case of aircraft forced down in a forested area, the best indicator may be broken treetops.
- The craft having sunk without a trace. Other than the case of a small ship or craft in rough weather, experience has shown that there are usually some traces, even if only debris or oil patches.

Navigational inaccuracies of searching ships

- This is most likely to apply when navigational fixes cannot be obtained. In this situation, the OSC may:
 - re-search the same area, allowing for added drift during the time elapsed since calculating last datum;
 - expand the most probable area, after allowing for added drift, and search the expanded area; or
 - expand the area more in one direction than another, depending on circumstance and information available.
- Determine a new probable area based upon any additional information received.
- Where information is received to indicate that the original datum was grossly inaccurate, determining an entirely new probable area would be advisable.
- A small search object, which is easily missed in the daytime, may become visible at night if it shows lights, flares, or other pyrotechnics.
- The SMC and OSC should, therefore, consider using surface craft at night to search again areas covered by day.
- It is good practice when searching for survivors in small craft, in survival craft, or in the water, to stop the engines occasionally at night and in restricted visibility by day to listen for cries for help.

Evidence of distressed craft found

- In some cases, the search may provide evidence of the distressed craft without survivors being found.
- This evidence may provide information for a recalculation of datum and revision of the search area.
- A low-lying, half-sunken loaded ship or aircraft may drift more slowly than a floating survival craft, even if a drogue is used.
- A derelict may drift at a considerable angle off the prevailing wind direction.

- When wreckage is located it usually consists of debris, possibly with an oil slick.
- Should this have come from the distressed craft, survival craft will usually be found downwind from the debris.
- In some cases, however, a ship may have been abandoned some time before sinking, in which case survival craft may be upwind.
- ~~If it is known, or suspected, that survivors are in the water, the area into which they may have been forced by the buffeting of the seas should also be checked.~~

Manoeuvring instructions

- International Regulations for Preventing Collisions at Sea continue to apply fully while carrying out searches.
- Manoeuvring and warning signals will be of particular importance in the circumstances.
- The master of any ship taking part in a search should endeavour to carry out all directions received and have due regard for the safety of the ship and crew.
- To initiate and conduct coordinated search patterns, the OSC should transmit a limited number of manoeuvring instructions by the most appropriate means, and in plain language when practicable.
- The text of the message for the initiation of a pattern and subsequent messages relating to its conduct or adjustment should be in standard form. The International Code of Signals may serve this purpose and a list of standard text from it follows:

Text or meaning	Code groups
Carry out search pattern _____ starting at _____ hours. Initial course _____, search speed _____ knots.	FR1
Carry out radar search, ships proceeding in loose line abreast at intervals between ships of _____ miles. Initial course _____, search speed _____ knots.	FR2
Vessel indicated (<i>call sign or identity signal</i>) is allocated track number _____.	FR3
Vessel(s) indicated adjust interval between ships to _____ miles.	FR4
Adjust track spacing to _____ miles.	FR5
Search speed will now be _____ knots.	FR6
You should alter course to _____ (at time indicated).	MH
Your should steer course _____.	MG
Alter course as necessary to next leg of track now (<i>or at time indicated</i>).	FR7

- Other useful signals in the International Code of Signals:

Text or meaning	Code groups
I am (or vessel indicated is) in charge of coordinating search.	FR
My maximum speed is _____ (number) knots.	SJ
I have no radar.	OI
I have an echo on my radar on bearing _____ , distance _____ miles.	ON
I am altering course to _____ .	MI

- Unless a time is specified in the text, individual ships should proceed as necessary to perform the purpose of the message on receipt.
- Should circumstances require the OSC to direct the ships participating in a pattern to carry out a major alteration of course (anything over 90°) before proceeding to a new area, it would be desirable for the OSC to direct this in two steps.

Search unsuccessful

- The OSC should continue the search until all reasonable hope of rescuing survivors has passed.
- The OSC may need to decide whether to terminate an unsuccessful search. This should be discussed with an RCC whenever practicable. For this determination, factors to consider include the following:
 - probability that survivors were in the search area
 - probability of detection of the search object, if it were in the areas searched
 - time remaining that search facilities can remain on-scene
 - probability that survivors might still be alive.
- The following diagram shows realistic survival times for people believed to be in water at various temperatures. If there is a possibility that survivors may have survival equipment or have been able to get out of the water, search times should be extended.
- Remember that the graph can only be indicative. Predicting survival times in immersion victims is not a precise science; there is no formula to determine exactly how long someone will survive or how long a search should continue. In water temperatures above 20°C (68°F) search times exceeding 24 hours should be considered.

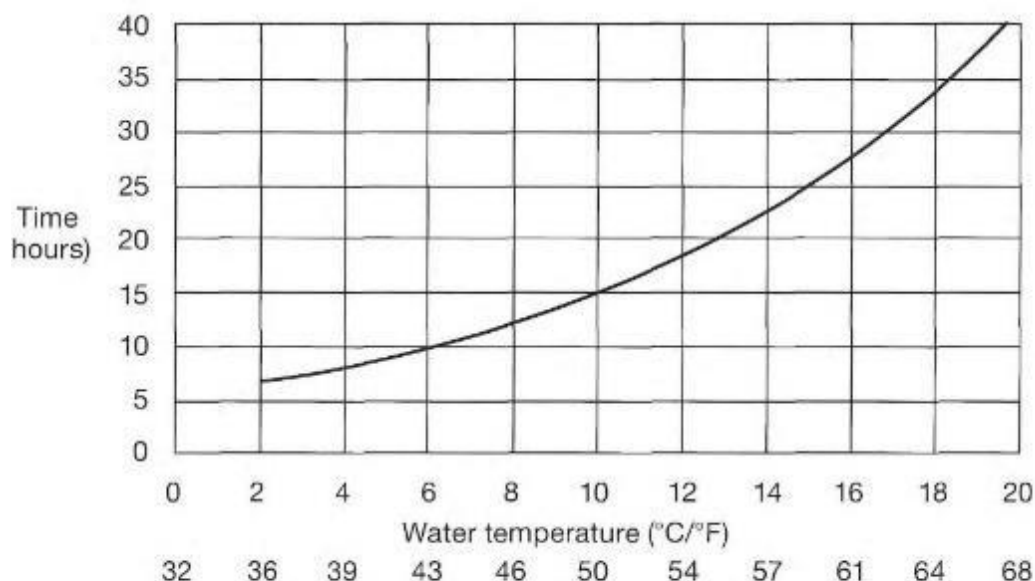

Graph on realistic upper limit of survival time for people in the water wearing normal clothing, from time of entry into the water

- The OSC, after consultation with other assisting craft and land-based authorities / RCC, should take the following action:
 - terminate active search and inform the RCC
 - advise assisting craft to proceed on passage
 - send a message to all ships in the area asking them to continue to keep a look-out.

Search successful

- Once the distressed craft or survivors have been sighted, the OSC should assess the best method for the rescue and direct the most suitably equipped craft to the scene. See ~~section 2, Rescue function,~~ sections 13, 14 & 15 for discussion on rescue by various types of SAR facilities.
- Ensure that all survivors are accounted for.
- Survivors should be questioned concerning:
 - the ship or aircraft in distress, number of persons on board
 - whether other survivors or survival craft have been seen
 - this information should be promptly relayed to the SMC.
- When all persons in distress have been accounted for, the OSC should inform all search facilities that the search has been terminated.
- The OSC should inform the SMC of the conclusion of the search and give the following details:

- names and destinations of ships with survivors, and identities and numbers of survivors in each
- physical condition of survivors
- whether medical aid is needed
- the state of the distressed craft and whether it is a hazard to navigation.

Section 13 – Rescue action plan

Section contents

Rescue action plan and message

Developing a rescue plan

Rescue action plan and message

- A rescue action plan is normally prepared by the SMC for implementation by the OSC and ACO (if designated) and facilities on-scene, and may be provided to them in a rescue action message.
- Potential parts of the message, similar to those for a search action message, are as noted below.

Situation

- includes a brief description of the:
 - incident
 - number of persons requiring rescue
 - extent of injuries
 - amount and type of survival equipment
 - weather forecast and period for forecast
 - SAR facilities on-scene

Rescue area

- describes the position of the incident
- gives access routes to be followed by SAR facilities

Execution

- lists SAR facilities assigned, including facility call sign and parent agencies providing them
- rescue method to be attempted
- lists supplies or equipment to be delivered

Coordination

- designates the SMC, OSC and ACO
- on-scene time for SAR facilities

- change of operational coordination (SAR facility follows coordinating guidance of SMC, OSC and/or ACO)
- parent agency relief instructions
- temporary flight restrictions
- authorization for non-SAR aircraft in the area

Communications

- prescribes coordination and on-scene channels
- call signs of aircraft assigned high-altitude communications relay duties
- other relevant communications information.

Reports

- discusses required OSC to SMC reports
- parent agency activity reports.

Developing a rescue plan

- Although the SMC normally prepares a rescue plan, sometimes the OSC may have to develop it.
- Factors to consider include:
 - risk to SAR personnel
 - number, location and disposition of the survivors
 - condition of survivors and medical considerations
 - current meteorological conditions
 - current sea conditions, as appropriate
 - time of day
 - survival equipment on hand
 - type of rescue craft, etc.
- In a distress incident, even uninjured persons who are supposedly able-bodied and capable of logical thought are often unable to accomplish simple tasks and may hinder their own rescue.

Section 14 – Rescue or assistance by vessels

Section contents

Rescue by maritime facilities – general considerations

Medical support

 Ocean incident

 Coastal incident

Recovery of survivors by assisting vessels

Rescue by maritime facilities – general considerations

General maritime considerations

- For information on preparing vessels to assist in rescue, see section 6.
- See also "Recovery of survivors by assisting vessels", below, and the action card "Master's checklist – Recovery of people in the water". The IMO publication Pocket Guide to Recovery Techniques and the ICS publication *Large Scale Rescue Operations at Sea: guidance on ensuring the safety and security of seafarers and rescued persons* (available for download from www.ics-shipping.org) provide additional guidance.
- The rescuing vessel may find it necessary to:
 - use recovery equipment
 - launch rescue boats
 - launch liferafts or other survival aids
 - have crew members suitably equipped to assist survivors
 - provide initial medical treatment.
- For a fire or extremely heavy weather, or where it is impossible for the rescue ship to come alongside, then a lifeboat or liferaft may be towed to a closer position.
- In heavy weather, an area of sea may be calmed significantly by a large vessel circling at reduced speed.
- Oil may also be used for quelling waves: vegetable oils and animal oils, including fish oils, are most suitable
 - fuel oil should not be used, except as a last resort, as it is harmful to persons in the water
 - lubricating oil is less harmful, and tests have shown that 200 L litres discharged slowly through a rubber hose with an outlet just above the sea, while the ship proceeds at slow speed, can effectively quell a sea area of some 5,000 m²
- A ship with a low freeboard may be better suited to effect rescue.
- A boarding station may be rigged by mooring a liferaft alongside.
 - it is particularly useful when lifeboats are used
 - survivors can be quickly unloaded into the boarding station, releasing the boat for another trip.
- The direction of approach to the distressed craft (or survivors) will depend upon the circumstances.

- some emergencies, such as a ship on fire, may have to be approached from windward and others, such as liferafts, from leeward.
- the two key factors are:
 - whether a lee-side protection is necessary during the rescue operation and
 - the comparative rates of drift of the distressed craft and the rescuing ship.
- If time permits, assess the relative rates of drift.
 - this precaution may prevent serious mishaps during the rescue operations
 - in general, survivors in the water are best approached from the leeward side.

Medical support

- If practicable, arrange for injured personnel requiring the attention of a medical officer to be transferred to a ship carrying one.
- See also section 3.

Ocean incident

- If there is no ship available with a medical officer on board, the rescue facility should request the OSC, if assigned, or the SMC to consider transmitting an urgency message requesting such a ship to a rendezvous.
- If necessary, a CRS may be contacted for ship reporting systems information on the availability of ships with a medical officer.

Coastal incident

- The SMC should arrange for medical assistance to be sent from shore.
- The local CRS may act as an intermediary.

Recovery of survivors by assisting vessels

- Vessels to which Chapter III of the SOLAS Convention applies shall have, and other vessels are recommended to have, ship-specific plans and procedures for recovery of people from the water. The action card "Master's checklist – Recovery of people in the water" and the IMO publication Pocket Guide to Recovery Techniques provide additional guidance.
- Seafarers should consider how to recover survivors into their own vessels under various environmental conditions. Recovery methods include:
 - using throwing rockets or heaving lines to pass lifebuoys and/or lines to survivors
 - streaming a rope, with lifebuoys or other flotation attached
 - utilizing specialized recovery equipment
 - rigging pilot ladders, jacob's ladders or nets, preferably clear of the ship's side, with safety lines. If survivors are unable to climb, ladders or nets may have to be recovered with the survivors secured to them. Where practicable:
 - rig ladders or nets from pilot doors or other low openings
 - deploy safety lines with rescue strops or loops
 - use suitably equipped crew members to assist survivors directly

- deploy a liferaft with the ladder or net to act as a transfer platform
 - pulling survivors up suitable marine evacuation systems
 - deploying liferafts or lifeboats for survivors to hold onto, or climb into
 - using rafts or boats as lifts, leaving them on the falls if conditions permit
 - lifting survivors using gantries, cranes, davits or derricks, with lines rigged to minimize swinging against the ship's side
 - deploying purpose-built or improvised recovery baskets
 - rigging a boat rope for boats and survival craft to secure alongside
 - lowering embarkation ladders.
- Any lights in use must not be directed towards helicopters operating in the area.
 - Survivors in the water should be lifted in a horizontal or near-horizontal position if possible (for example, in two strops or loops; one under the arms, the other under the knees) to minimize the risk of shock induced by sudden transfer from the water and possible hypothermia. However, especially for short lifts, do not delay if the survivor's airway (mouth/ nose) is threatened by, for example, backwash from the rescuing vessel, but lift by the quickest method. If a rescue craft has been deployed to recover the survivor, he should, if possible, remain in the craft during its recovery on board the ship.
 - Assisting vessels should also be prepared to receive survivors from helicopters: see ~~page 2-23~~ section 16.
 - When the risks involved in recovery operations outweigh the risks of leaving the survivors in life-saving appliances, consider the following actions:
 - using the ship to provide a lee for the survivors;
 - deploying life-saving appliances from the assisting vessel;
 - maintaining visual and communications contact with the survivors;
 - updating the coordinating authority;
 - transferring essential survival and medical supplies.

Section 15 Rescue or assistance by aircraft

Section contents

Assistance by SAR aircraft – supply dropping

Assistance by helicopters

Rescue sling

Double lift method

Rescue basket

Rescue net

Rescue stretcher

Rescue seat

Long range operations

Long range procedures

Bringing a casualty vessel within range

Assistance by SAR aircraft

Supply dropping

- Assistance by aircraft during a SAR mission can include dropping liferafts and equipment to craft in distress, ~~lowering trained individuals from helicopters, or evacuating survivors by helicopter.~~
- Ships in distress or survivors may be supplied by SAR aircraft with special items of droppable equipment.
- Suggested procedure for aerial delivery of rafts, supplies, and equipment to persons in watercraft or in water:
 - approach slightly ~~upward~~ **upwind of the craft or person** and perpendicular to the wind direction
 - drop item(s) with 200 m buoyant trail line attached to a position 100 m ahead of survivors
 - let trail line fall so that it will float downwind to survivors.
- The contents of each container or package should:
 - be clearly indicated in print, in English and ~~one or more other languages~~ **additional languages appropriate to the intended area of operation**
 - ~~have self-explanatory symbols~~ **be clearly identified by self-explanatory pictograms in retroreflective material as shown below:**

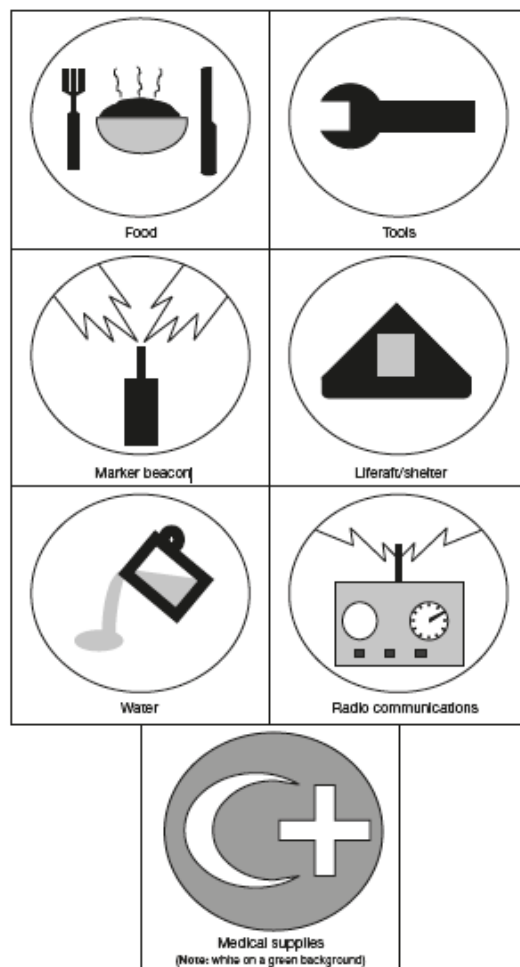

— have streamers coloured according to the following code:

- Red — medical supplies and first-aid equipment
- Blue — food and water
- Yellow — blankets and protective clothing
- Black — miscellaneous equipment such as stoves, axes, compasses, cooking utensils, etc.

- Miscellaneous equipment includes:
 - individual liferafts
 - liferafts linked by a buoyant rope
 - buoyant radio beacons and transceivers
 - dye and smoke markers and flame floats
 - parachute flares for illumination
 - salvage pumps.
- The following factors should be considered when deciding whether or not supplies should be dropped:
 - communications with the survivors
 - supplies needed by survivors

- availability of suitable aircraft and trained crew.
- Success of an air drop is affected by:
 - correct release point
 - drift effect of the wind
 - speed and height of the aircraft
 - relative locations of the distress site and the rescue facility's base
 - time before rescue can be effected
 - danger of exposure.

Assistance by helicopters

- A helicopter may be used to supply equipment and rescue or evacuate persons.
- The radius of helicopter action usually varies up to 300 ~~nautical miles (NM)~~ NM from base, but it can be greater, especially with air-to-air refuelling.
- Lifting capacity is between one and up to 30 persons depending on the size and type of aircraft.
- Rescue operations involve helicopter crew risks which should be minimized.
 - it is essential to evaluate the seriousness of the situation, and to ascertain the need of helicopter assistance.
 - The helicopter's mass may be a factor limiting the number of survivors taken on board each trip.
 - it may be necessary to reduce the mass of the helicopter by removal of non-essential equipment, or using minimum fuel loads and advance bases with fuelling capabilities.
- For the evacuation of persons, the end of a winching cable may be provided with a rescue sling, basket, net, stretcher or seat.

Rescue sling

- The most widely used means for evacuating persons is the rescue sling, if possible together with a helicopter crew member.
- Slings are suited for quickly picking up uninjured persons, but are unsuitable for persons with injuries.
- The sling is put on in much the same way as one puts on a coat, ensuring that the loop of the sling passes behind the back and under both armpits.
- The person using the sling must face the hook. Hands should be clasped in front as shown.
- The person must not sit in the sling, nor should the sling be unhooked.
- Experience has shown that when winching a person suffering from hypothermia, especially after immersion in water, a rescue basket or stretcher or a second sling (under the knees) should be used to keep the person in a horizontal or near-horizontal position, since winching in a vertical position may cause severe shock or cardiac arrest.

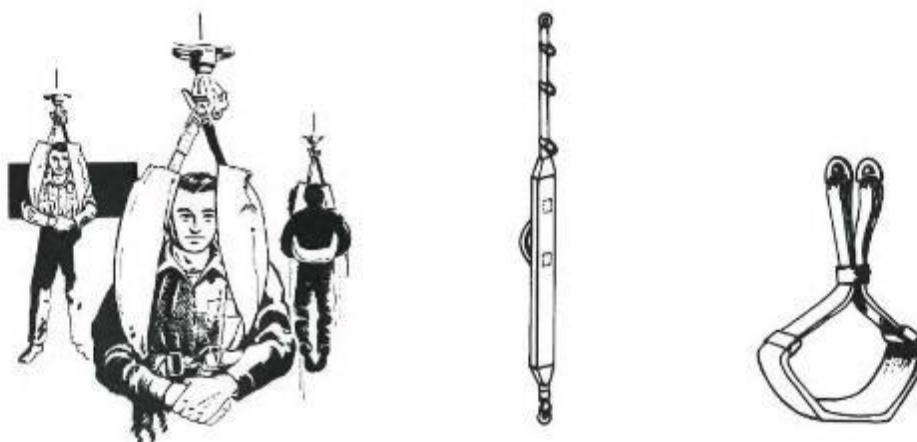

Rescue sling

Double lift method

- Most SAR helicopters use the double lift method which consists of a normal sling and a seating belt manned by a helicopter crew member.
- This method is suitable for pick-up of incapacitated persons from land, water, or the deck of a vessel, if they are not injured badly enough so that a stretcher has to be used.
- The helicopter crew member puts the person into the sling and conducts the winching operation.

Rescue basket

- Use of the rescue basket does not require any special measures. To use the basket, the person merely climbs in, remains seated and holds on.

Rescue net

- The rescue net has a conical "bird cage" appearance and is open on one side.
- To use the net the person merely enters the opening, sits in the net, and holds on.

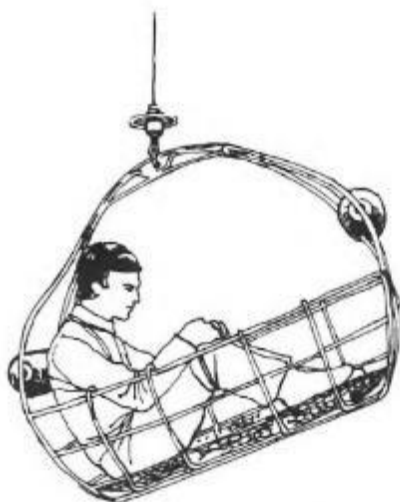

Rescue basket

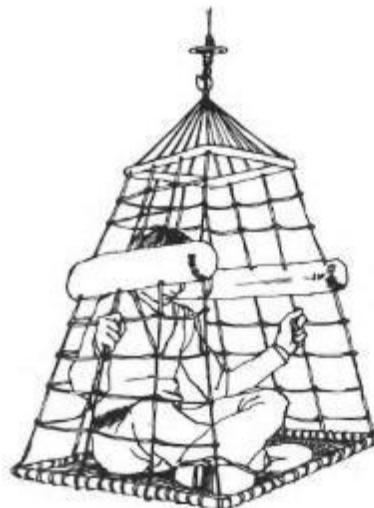

Rescue net

Rescue stretcher

- Patients will in most cases be disembarked by means of a rescue stretcher.
- The evacuation of patients can be done in a special stretcher provided by the helicopter or in a litter provided at the site (if approved by the helicopter crew).
- Bridles are fitted to this stretcher and can quickly and safely be hooked on and off.
- The stretcher provided by the helicopter should be unhooked from the winch cable while the patient is being loaded.

Rescue seat

- The rescue seat looks like a three-pronged anchor with two flat flukes or seats.
- Persons to be hoisted merely sit astride on one or two of the seats and wrap their arms around the shank.
- This device can be used to winch two persons at once.

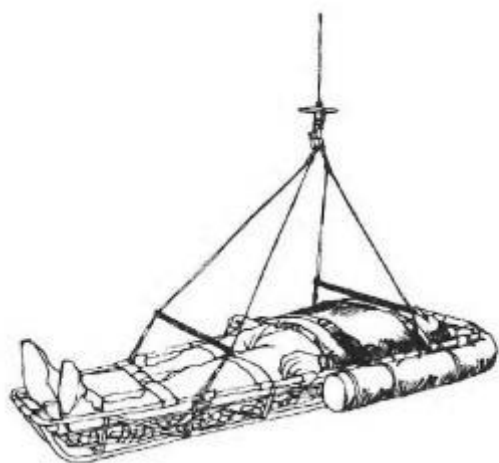

Rescue stretcher



Rescue seat

Long range operations

General

Long range is any distance that significantly limits or compromises the ability of SAR aircraft to operate on-scene effectively and safely.

Long range procedures

- At long ranges, SAR aircraft might need to minimize the fuel used while flying in transit, in order to permit more time operating on scene.
- It might be necessary for SAR aircraft to fly as directly as possible to and from an incident, with the result that multiple aircraft SAR procedures have to be modified and rely on basic safety arrangements.
- These arrangements could include separate arrival times on-scene and basic inbound and outbound height differences in order to keep aircraft safely apart.
- Additional considerations for long range SAR communications are described earlier in this in section 8.

Bringing a casualty vessel within range

- If the casualty is a vessel underway, SMCs should consider the possibility of directing requesting it to move to a point within the effective range of SAR aircraft or other forms of assistance.

Alternatively, it might be possible for SAR aircraft to refuel at locations that effectively bring a casualty within their maximum radius for SAR operations. It is also effective for SMCs to use both of these options at the same time.

Section 16 – Vessel / helicopter operations

Section contents

Helicopter operations

Communications between vessel and helicopter for winching operations

Sample briefing to vessel prior to helicopter winching

Guidance for vessels

Positioning of landing or pick-up areas

Hi-line technique

Vessel preparation

Other considerations

Safety preparations

Shipboard safety checklist

Safety precautions when approaching or leaving a helicopter

Helicopter operations

General

- Helicopter operations include landing and winching on land or at sea. Landings on vessels will normally be done on well-equipped and trained craft. Discussion here will focus on winching since it may be conducted for various trained and untrained facilities. Winching can be hazardous to the persons being hoisted, the rescue facility, and others at the scene of the winching.
- Follow the instructions of the rescue facility and inform when unable to do so. In principle, only act after instructions of the rescue facility have been received.
- The final decision about whether it is safe to conduct the winching, subject to agreement of personnel at the scene, is with the person in command of the rescue facility. The distressed vessel's captain is responsible for the safety of his vessel and personnel and may decide against the winching.
- The vessel or the ground facility at the rescue scene should be briefed on what is required. A sample briefing is provided after this discussion. This briefing can be given by another SAR facility prior to the on-scene arrival of the helicopter.

Communications between ship and helicopter for winching operations

- It is important that information be exchanged between the vessel and helicopter, and that it is understood.

- A direct radio link should be established between ship and helicopter. This is usually accomplished by having the helicopter equipped with a marine VHF FM radio able to transmit and receive on at least channel 16 and preferably on two other simplex working frequencies.
- The following information should be exchanged between the helicopter and the vessel:
 - position of the vessel
 - course and speed to the rendezvous position
 - local weather conditions
 - how to identify the vessel from the air (such as flags, orange smoke signals, spotlights, or daylight signalling lamps).
 - type and any special activity of the ship
- The exchange of information and instructions about rendezvous positions, etc., may be established through shore-based radio stations.
- Unless other arrangements have been agreed upon in advance, the ship should monitor VHF channel 16 for the arrival of the helicopter.
- When the helicopter is equipped for DF, it can identify the ship and home on it by using the ship's radio transmission on an agreed frequency.
- To avoid any misunderstandings, the following is a selection of internationally-developed phrases which may be used as appropriate.

Helicopter to ship

- Join me on VHF channel ...
- Query – what is your exact position?
- Please transmit a long homing signal on 410 kHz...
- Query – what is your course?
- Query – what is your speed?
- Query – what is the present relative wind direction and speed across your deck?
- Query – what are the pitch, heave, roll, sea, and spray conditions at the operating area?
- I understand that your vessel has
 - a landing area with a clear zone of ___ metres in diameter on the port/starboard side/centre line, or
 - a pick-up area with a manoeuvring zone of ___ metres in diameter on the port/starboard side. I propose to serve you on the port/starboard/centre line landing/pick-up area.

- I will be overhead your vessel in ___ minutes.
- I have you in sight.
- Query – is the ship ready?
- Query – is the deck party ready?
- Query – is the operating area clear of unnecessary personnel?
- Query – is the fire-fighting equipment ready?
- Please confirm that there are no obstructions above the operating area.
- Please confirm that all passengers have been briefed on winching procedures.
- Please confirm permission to land.
- I am standing by.
- I expect to be ready in ___ minutes.
- Please maintain your course and speed (if possible).
- Can you alter course to ___ degrees?
- Can you reduce/increase speed to ___ knots?
- Please advise when you have steadied on your new speed/course.
- Can you resume your original course and speed?
- Acknowledgement.

Ship to helicopter

- My vessel's position is ___ degrees ___ miles from ___ (prominent point).
- My vessel has
 - o a landing area with a clear zone of ___ metres diameter on the port/starboard side/centre line, or
 - o a pick-up area with a manoeuvring zone of ___ metres diameter on the port/starboard side.
- My vessel is/is not ready for you to approach.
- Stand by. I expect to be ready for you to approach in ___ minutes.
- My present course is ___ degrees.
- My present speed is ___ knots.
- The relative wind is ___ degrees at ___ knots.

- I am shipping light spray on deck/heavy spray on deck.
- I am pitching/rolling moderately/heavily.
- Query – do you wish me to alter course?
- Query – do you wish me to reduce/increase speed?
- The ship is ready – all preparations have been made.
- Affirmative: you have permission to proceed with the operation.
- Affirmative: you have permission to land.
- Acknowledgement.
- Means of communication between ship and helicopter are further indicated in the International Code of Signals – General Section, DISTRESS – EMERGENCY under AIRCRAFT – HELICOPTER.

Sample briefing to vessel prior to helicopter winching

(Modify text for helicopter winching over land)

"A helicopter is proceeding to your position and should arrive at approximately _____. Maintain a radio watch on ____ MHz/kHz/channel ____ VHF-FM. The helicopter will attempt to contact you and instruct you about the winching procedures. Provide a clear area for winching, preferably on the port stern. Lower all masts and booms that can be lowered. Secure all loose gear. Keep all unnecessary people clear of the pick-up area. Just before the helicopter arrives, secure the ship's radar or put it in standby mode. Do not direct lights towards the helicopter as it will adversely affect the pilot's vision. Direct available lighting to illuminate the pick-up area. When the helicopter arrives, change course to place the wind 30° on the port bow and maintain a steady course and steerageway. As the helicopter approaches, strong winds may be produced by the rotors, making it difficult to steer. The helicopter will provide all the equipment for the winching. A line will probably be trailed from the helicopter for your crew to guide the rescue device as it is lowered. Before touching the rescue device, allow it to touch your vessel. This will discharge static electricity. If you have to move the rescue device from the pick-up area to load the patient, unhook the cable from the rescue device and lay the loose hook on the deck so it can be retrieved by the helicopter. If a helicopter crewman is lowered down, follow his instructions. If this is not the case, act as follows:

- Do not attach the loose hook or the trail line to your vessel.
- If you have to move the rescue device from the pick-up area to load the patient, unhook the cable and trail line from the rescue device and lay the loose hook on the deck so it can be retrieved by the helicopter.
- The helicopter may move to the side while the patient is being loaded.
- Have the patient wear a lifejacket and attach any important records, along with a record of medications that have been administered.
- When the patient is securely loaded, signal the helicopter to move into position and lower the hook.

- After allowing the hook to ground on the vessel, re-attach the hook and the trail line to the rescue device.
- Signal the winch operator with a "thumbs up" when you are ready for the winching to begin.
- As the rescue device is being retrieved, tend the trail line to prevent the device from swinging.
- When you reach the end of the trail line, gently toss it over the side."

Guidance for vessels

Positioning of landing or pick-up areas

- Operating areas on vessels should be located on the main deck and, if practicable, arranged on both port and starboard sides.
 - the operating areas consist of an outer manoeuvring zone and an inner clear zone
 - whenever possible, the clear zone should be close to the ship's side
 - any amount of the manoeuvring zone may extend outboard but none of the clear zone may do so.
- Identify clear access to the operating area and exit from it to the ship's side.
- Establish the best position within the area for the manoeuvring zone that will give the largest clear zone.
- Areas close to the bow are not recommended due to the increased air-flow turbulence created by the ship's passage.

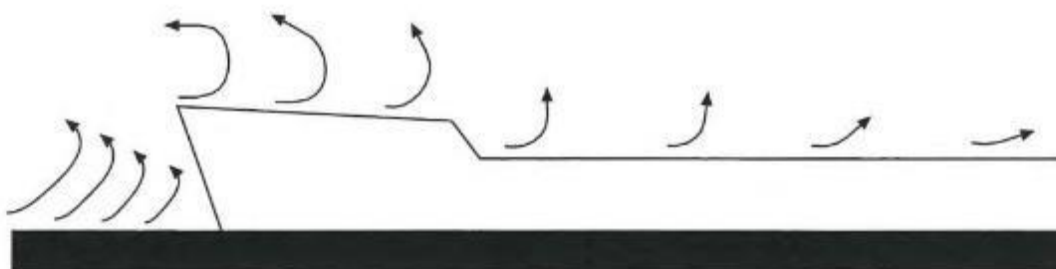

- As large a stretch of deck as possible which is clear of obstructions should be made available as a pick-up area.
- Larger vessels may have areas marked on their decks. These markings are an aiming circle with "H" painted in white for landing, or a circle with an inner circle painted yellow for winching only, as shown below.

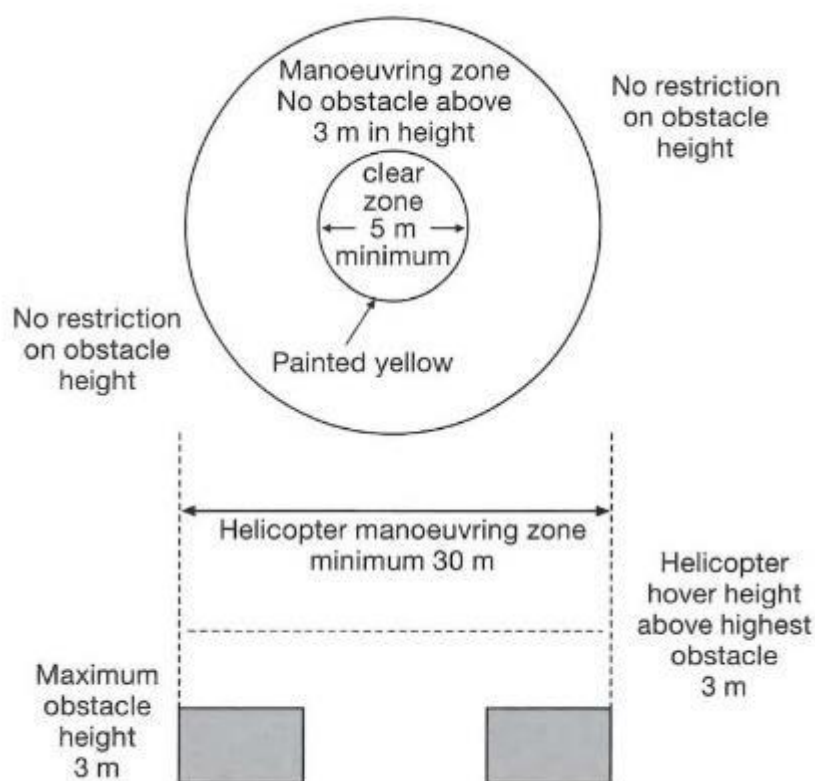

- During the night, pick-up area floodlighting should be provided and the floodlights should be located so as to avoid glare to pilots in flight or to personnel working on the area.
 - the arrangement and aiming of floodlights should be such that they are not directed towards the helicopter and shadows are kept to a minimum
 - the spectrum distribution of the floodlights should be such that the surface and obstacle markings can be correctly identified
 - obstacles should be clearly identified by obstacle lights
 - where pick-up area floodlighting and obstacle lighting cannot be provided, the ship should, in consultation with the pilot, be illuminated as brightly as possible, particularly the pick-up area and any obstructions, such as masts, funnels, deck gear, radar antenna, etc.
- Loose objects should be cleared away or secured due to downwash from the helicopter.
- The helicopter may be able to lift a person from a lifeboat or a liferaft secured on a long painter. However, liferafts have been overturned by the helicopter's downwash.

Hi-line technique

- In certain circumstances, typically, poor weather, obstructed vision or confined winching area, it may not be possible to lower the helicopter crewman or lifting harness to the deck from directly above the vessel. In such cases the hi-line technique may be used.

- A weighted line, attached to the aircraft's hook by a weak link, is lowered to the vessel. It may be illuminated by cyanine lightsticks. The transfer area should give unobstructed access to the deck edge.
- The line should be handled by one member of the vessel's crew.
- ONLY WHEN INSTRUCTED BY THE HELICOPTER CREW the slack should be hauled in (it is advisable to wear gloves).
- THE LINE MUST NOT BE MADE FAST ATTACHED TO THE VESSEL.
- The helicopter will pay out the line and descend to one side of the vessel while the crewman continues to take in the slack. A second crewmember should coil the spare line into a container, clear of obstructions.
- When the helicopter crewman or lifting harness reaches deck height the line must be hauled in to bring the winch hook on board (considerable effort may be required).
- The static discharge line must touch the vessel before contact with the hook is made.
- At any time the helicopter may discontinue the operation, in which case the line must be paid out immediately, clear of obstructions.
- When prepared for winching the helicopter crewman, if present, or a member of the vessel's crew, should indicate to the helicopter by hand signals.
- The helicopter will climb and winch in the cable. The line must be paid out maintaining sufficient force to prevent a swing.

If multiple transfers are required to be made the line should be retained. On the final lift the end of the line should be released over the side of the vessel.

Vessel preparation

SRUs

- Vessels taking part in a SAR mission in the vicinity of aircraft operations, should consider the following:
 - keep clear of aircraft approach path (~~area between Final Point and distress vessel~~)
 - keep clear of missed approach flight path
 - inform ACO/OSC/SMC of any activity observed in above-mentioned areas
 - ask ACO for guidance concerning the placement of the areas mentioned above in case they are unclear
 - the ACO/OSC/SMC may also ask a surface SRU to remain in a certain position relative to a distressed vessel to accommodate operational needs; for example, to act as an approach fix for aircraft airborne radar approaches
 - in search missions including both airborne and surface units, keep the ACO/OSC/SMC aware of own position as advised.

Distress vessel

- ~~In addition to other guidance given to vessels, in multiple aircraft SAR operations or mass evacuation situations, the Master of the vessel in distress should agree with the ACO/OSC/SMC on cooperation with airborne units: with ACO/OSC/SMC including:~~
 - determine landing/hoist positions
 - determine working channels
 - inform when ready to receive helicopters
 - be prepared to provide ship manifest to RCC or SRU
 - be prepared to guide rescue personnel arriving on ship
 - be prepared to gather passengers to landing/hoist positions and to guide them
 - determine number of casualties and their medical triage status ~~and number of casualties~~
 - plan order of evacuation and relay to RCC/OSC/ACO
 - update vessel position, speed and course at regular intervals; 1 NM can be considered a significant difference in position for aircraft especially in poor weather conditions.

Other considerations

- Vessels which are not well suited for helicopter landing operations (due to their size, design or nature of their cargoes) should carefully consider how ~~to best to~~ remove or deliver ~~these~~ people or equipment in an emergency.
- ~~Emergency procedures might consist of evacuation of an injured person or delivering a doctor on board by winching.~~
- ~~For further information regarding helicopter operations, vessel preparations, and safety briefing, see section 3.~~

Safety preparations

- A briefing to discuss the safety aspects and operational details of helicopter-ship operations should be held for all involved personnel prior to the operation's commencement.
- Wherever available, the following fire-fighting equipment or its equivalent should be ready during helicopter operations:
 - at least two dry powder extinguishers with an aggregate capacity of not less than 45 kg
 - a suitable foam application system (fixed or portable), capable of delivering a foam solution at a rate of not less than 6 L-litres per minute for each square metre of clear zone and sufficient foam compound to enable the rate to be maintained for at least five minutes

- carbon dioxide (CO₂) extinguishers with an aggregate capacity of not less than 18 kg
 - a deck water system capable of delivering at least two jets of water to any part of the helicopter operating area
 - at least two fire hose nozzles which should be of the dual-purpose type
 - fire-resistant blankets and gloves
 - sufficient fire proximity suits
 - portable fire-fighting equipment for oil fires should be stationed near the disembarkation space
 - if possible, the fire-fighting pump should be started and hoses should be connected and kept in readiness.
- For better identification from the air, and also for showing the direction of the wind to the helicopter pilot, flags and pennants should be flown.
 - All crew members concerned, as well as the persons to be evacuated, should wear lifejackets
 - this precaution may be amended when it would cause unjustifiable deterioration of the condition of the patient to be transferred.
 - Care should be taken that the ~~patient does~~ deck party and persons to be evacuated do not wear loose clothing or headgear.
 - On no account should the lifting device or the trail line on the end of the winch cable be secured to any part of the ship or allowed to become entangled in the rigging or fixtures.
 - Never fix a trail line to a person.
 - Ship's personnel should not attempt to grasp the lifting device unless requested to do so by the helicopter crew.
 - even in this case, a metal part of the lifting device should first be allowed to touch the deck in order to avoid possible shock due to static electricity.
 - When helicopter winching is to be done from carriers of flammable or explosive cargo, or in the vicinity of a flammable mixture spillage, the winching must be grounded clear of spillage or the carrier's tank venting area in order to preclude a possible fire or explosion from an electro-static discharge.
 - The helicopter pilot will want to approach the ship in such a way that the helicopter will hover into the relative wind and with the pilot's side (starboard) closest to the ship during the approach.
 - If the helicopter is to approach in the usual manner, from the stern, the ship should maintain a constant speed through the water and keep the wind 30° on the port bow; or on either beam if the area is amidships; or 30° on the starboard quarter if the area is forward.

- A flow of air, as free of turbulence as possible, clear of smoke and other visibility restrictions, over the pick-up area is very important.
- These procedures may be modified on instructions from the pilot if communications exist.
- Personal belongings should not be taken along.
 - loose gear can become entangled in the winch cable or pulled up into the helicopter rotors.

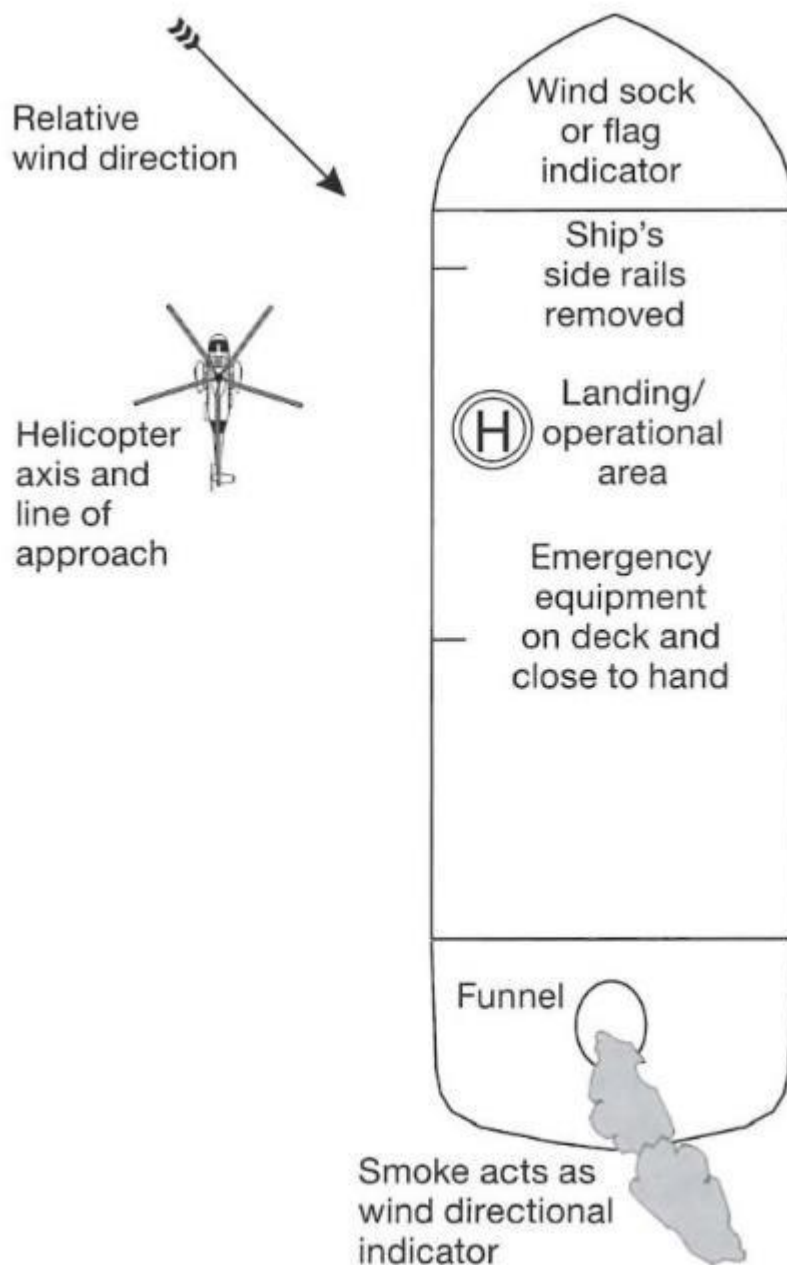

- The following diagrams show the appropriate day shape a vessel must display while engaged in helicopter operations and signals that may be used in winching communications:



Forward

Signal given to helicopter pilot to indicate that the vessel is ready and the helicopter may approach.
(Arms repeatedly moved upward and backwards, beckoning onward.)

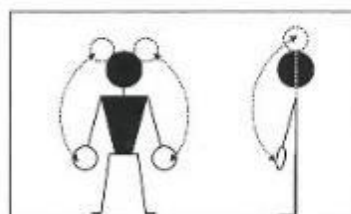

Finishing operations

Signal given to helicopter pilot to indicate operations finished or stop operations.
(Arms repeatedly crossed above the head.)

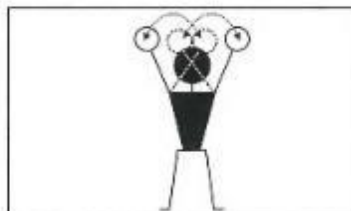

Helicopter operations

- The following checklist can help the ship's deck officer prior to helicopter–ship operations. The checklist was created for a large merchant vessel but provides information useful for any size vessel.

Shipboard safety checklist

To be checked by officer in charge.

General

- Have all loose objects within and adjacent to the operating area been secured or removed?
- Have all aerials, standing or running gear above the operating area been secured or removed?

- Has a pennant or windsock been hoisted where it can be clearly seen by the helicopter pilot?
- Has the officer of the watch been consulted about the ship's readiness?
- Does the leader of the deck party have a portable radio ~~transceiver (walkie-talkie)~~ for communicating with the bridge?
- Are the fire pumps running and is there adequate pressure on deck?
- Are fire hoses ready (hoses should be near to but clear of the operating area)?
- Are foam hoses, monitors, and portable foam equipment ready?
- Are dry powder fire extinguishers available and ready for use?
- Are the fire hoses and foam nozzles pointing away from the operating area in case of inadvertent discharge?
- ~~• Is the deck party complete, correctly dressed, and in position?~~
- Is the deck party ready, wearing brightly coloured waistcoats and protective helmets, and are all ~~passengers~~ **others** clear of the operating area?
- Has a rescue party been detailed?
- Is a rescue boat ready for lowering?
- Are the following items of equipment to hand?
 - Large axe
 - Crowbar
 - Wire cutters
 - Red emergency signal/torch
 - ~~– Marshalling batons (at night)~~
 - First-aid equipment
- Has the correct lighting (including special navigation lights) been switched on prior to night operations and not directed towards the helicopter?
- Has the hook handler been equipped with helmet, strong rubber gloves and rubber-soled shoes to avoid the danger of static discharge?
- Is access to and egress from the operating area clear?
- Has the radar been secured or placed in standby mode just before the helicopter arrives?

Landing on

- Is the deck party aware that a landing is to be made?
- Is the operating area free of heavy spray or seas on deck?
- Is the operating area clear of all loose and/or removable items?
- Have side rails and, where necessary, awnings, stanchions, **aerials** and other obstructions been lowered or removed?
- ~~Where applicable, have portable pipes been removed and have the remaining apex ends been blanked off?~~
- Are rope messengers to hand for securing the helicopter, if necessary? (Note: only the helicopter pilot may decide whether or not to secure the helicopter.)
- Have all personnel been warned to keep clear of rotors and exhausts?

Tankers: additional items

- *Ships not fitted with an inert gas system:* Has pressure been released from tanks within 30 minutes of commencement of helicopter operations?
- *Ships fitted with an inert gas system:* Has pressure in cargo tanks been reduced to slight positive pressure?
- *All tankers:* Have all tank openings been secured following venting operations?

Bulk carriers and combination carriers: additional items

- Has surface ventilation to dry bulk cargoes ceased, and have all hatch openings been fully battened down prior to helicopter operations?

Gas carriers: additional items

- Have all precautions been taken to prevent vapour emission?

Passenger vessels: additional items

- ~~Portable radio communication~~ Be prepared to communicate on 123.1 MHz / 121.5 MHz.

Safety precautions when approaching or leaving a helicopter

- Do not approach or depart a helicopter UNLESS directed to do so by the pilot or crewman.

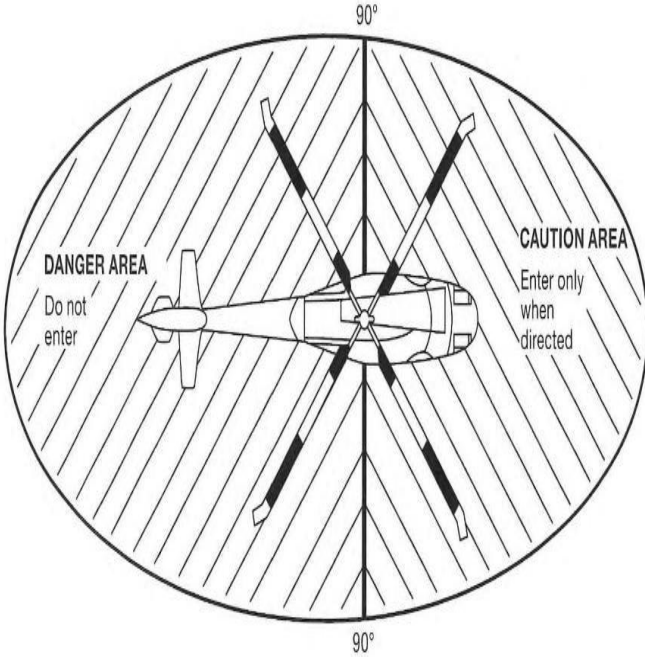

Generic safety illustration

Section 17 – Underwater search and rescue

Section contents

Underwater search and rescue

Underwater search and rescue

- In the event a mobile facility has reason to suspect that an underwater accident has occurred, every effort should be made to contact the nearest rescue coordination centre.
- When accidents occur, survivors may be either on the surface or entrapped in a submarine resting on the seabed.
- Generally, medical care requirements for survivors of an underwater or submarine accident is specialized and competent medical advice is required.
- Vessels believing they have collided with a submarine, as with a collision with any vessel, should anticipate a requirement to provide SAR assistance.
- Further information on submarine SAR and its parallel activity, submarine escape and rescue, may be found at the website maintained by the International Submarine Escape and Rescue Liaison Office.

Section 18 – Rescue on land

Section contents

Rescue by land facilities

Rescue by land facilities

- The duties of a land facility at a distress scene include:
 - giving initial medical treatment
 - collecting and preserving medical and technical data for investigatory purposes
 - making a preliminary examination of the wreckage
 - reporting to the SMC, and
 - evacuating survivors by whatever means are available.

- Aircraft crash sites have special requirements
 - Movement in the vicinity of crash sites can be extremely hazardous for ground parties on account of toxic fumes, dangerous substances (including radioactive substances) and explosives. Extreme care should be taken when approaching such a crash site and advice sought from RCC or expert authorities, wherever possible, before approaching crash site.
 - Personnel should wear personal protective equipment and all work should be carried out upwind of the wreckage wherever possible.
 - For military aircraft, extreme care should be taken to avoid hazardous materials, ordnance, leaking fuel tanks, pyrotechnics or triggering the ejection seat (the activating handles are normally coloured red or yellow-and-black). Expert advice should be sought before approaching the crash site, wherever possible.
 - Do not disturb aircraft wreckage except to the minimum necessary to assist in the recovery of survivors.
 - Except for compelling reasons, bodies or human remains should not be moved without authorization.
 - Some civil light aircraft are fitted with ballistic recovery parachute systems which eject a powerful rocket that pulls a parachute from a container attached to or in the airframe. Activation handles are normally coloured red and should not be touched or moved. The ejection hatch of the parachute rocket should be identified and personnel warned to keep clear.

• **Section 19 – Intercepts**

Section contents

Intercept and escort service

Direct intercepts

Aircraft intercepts

 Minimum time-to-scene intercept

Intercept and escort service

General

- The purpose of this service is to minimize delay in reaching the scene of distress and to perhaps eliminate a lengthy search for survivors. Escort service for both aircraft and vessels will normally be provided to the nearest adequate aerodrome or nearest safe haven.
- Intercept procedures apply to both vessels and aircraft. However, the higher rate of speed of aircraft often requires a more rapid calculation of the intercept course and speed.
- The following assistance can be provided by an escort:
 - provide moral support to the persons on board the distressed craft
 - assume the navigation and communication functions of the distressed craft, thereby permitting its crew to concentrate on coping with the emergency
 - visually inspecting the exterior of the distressed craft
 - advise on procedures for:
 - ditching an aircraft
 - abandoning a vessel
 - beaching a vessel
 - provide illumination during:
 - aircraft ditching
 - vessel abandonment
 - assist in the approach procedure at the destination
 - provision of emergency and survival equipment, carried by the escort facility
 - direct rescue facilities to the distress scene.
- The SMC may alert SAR facilities capable of providing an escort facility and dispatch an escort facility when appropriate.

Direct intercepts

- Three types of direct intercept are possible. They are the head-on, overtaking, and offset or beam-on intercepts. For direct intercepts, it is usually assumed that the SAR facility's speed is greater than that of the distressed craft.

- A distressed aircraft should not be asked to change its heading for a direct intercept unless the aircraft:
 - is lost
 - requires minor heading changes to correct for navigation error
 - is in imminent danger and cannot reach safety.

The head-on direct intercept solution:

- plot the simultaneous position of SAR facility and distressed aircraft
- the SAR aircraft flies facility follows a reciprocal track to that being flown by of the distressed aircraft-craft
- compute the distance between the simultaneous position plots and the rate of closure
- divide the distance separating the two aircraft-craft by rate of closure to determine the time of interception

or (graphical solution):

- plot the relative positions of both the distressed craft (A) and the intercepting SAR facility (B) for that time at which the intercepting SAR facility is ready to proceed
- join the two positions with a line (AB)
- lay off a line at 90° to the distressed craft's course made good and project it a reasonable distance (AC)
- along this line, measure off the distance it will cover in one hour, based on the speed it is making good, and mark the position with an X
- lay off a line at 90° to the intercepting SAR facility's course made good on the opposite side of AB and project it a reasonable distance (BD)
- along this line, measure off the distance the intercepting SAR facility will cover in one hour, based on the speed it can make good along its intended course, and mark the position with a Y
- join the positions X and Y with a line: where it cuts the course line is the intercept position, P
- to find the time for this intercept, measure the distance from the initial position of either craft to the position of intercept and divide this distance by the speed of the chosen craft.

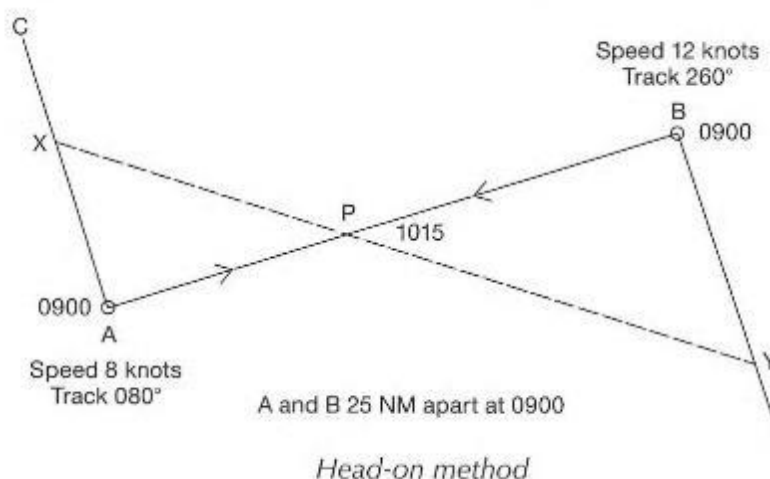

The overtaking direct intercept solution:

- plot the simultaneous position of SAR facility and distressed craft
- the SAR facility moves along the same track to that of the distressed craft
- compute the distance between the simultaneous position plots and the rate of closure
- divide the distance separating the two craft by rate of closure to determine the time of interception

or (graphical solution):

- plot the relative positions of both the distressed craft (A) and the intercepting craft (B) for that time at which the intercepting SAR facility is ready to proceed
- join the two positions with a line and project it a reasonable distance (BC): this line is the course made good of both craft
- lay off a line at 90° to the intercepting SAR facility's course and project it a reasonable distance (BD)
- along this line, measure off the distance the intercepting SAR facility will cover in one hour, based on the speed it can make good along its intended course, and mark the position with an X
- lay off a line at 90° to the distressed craft's course and project it a reasonable distance (AE) on the same side as BD
- along this line, measure off the distance the distressed craft will cover in one hour, based on the speed it is making good, and mark the position with a Y
- join the positions X and Y with a line and project it until it cuts the course line at F: this is the intercept position
- to find the time for the intercept, measure the distance from the initial position of either craft to the position of the intercept, and divide this distance by the speed of the chosen craft.

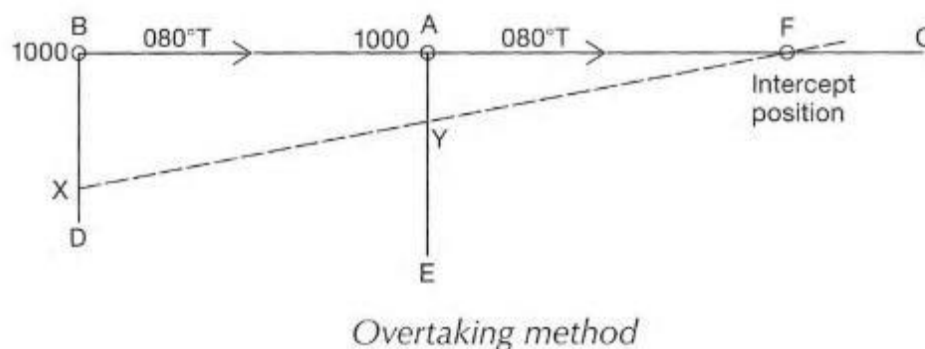

The offset or beam-on intercept:

- The offset or beam-on intercept is used when the SAR facility is to one side of the track being made good by the distressed craft.
- The SAR facility intercepts the track of the distressed ~~aircraft~~ craft.
- When the distressed craft has the greater ground speed, the SAR facility will have to be closest to the point of intended landing to make the offset interception possible. There are three methods for performing offset or beam-on intercepts.

Method 1:

- plot the relative positions of both the distressed craft (A) and the intercepting SAR facility (B) for that time at which the intercepting SAR facility is ready to proceed
- join these two positions with a line (AB)
- lay off the distressed craft's track in the direction of its heading and project it a reasonable distance on the chart (AC)
- along this projected track or course line of the distressed craft, measure off the distance it will cover in one hour, based on its speed through the air (TAS for aircraft) or water (vessels), and mark the position with an X
- transfer the line joining the two craft through the plotted position, X (XY)
- with the centre of the circle being the point of departure of the intercepting SAR facility, and using a radius equal to the distance it will cover in the time interval used for the distressed craft, describe an arc and mark the spot (W) where the arc cuts the transferred line

Note: If the speed of the intercepted or intercepting ~~vessel~~ craft is such that the scale of the chart makes it unreasonable to use a full hour, then it will be necessary to use a proportional interval of time to ensure that the radius of the arc cuts the transferred line.

- draw a line from the position of the intercepting SAR facility through the spot where the arc cuts the transferred line – this is the intercept heading/course for the intercepting SAR facility. By projecting this line until it cuts the projected track or course line of the distressed craft, one finds the position where the intercept will take place (D)

- the bearing and distance of the line drawn from the original position of the SAR aircraft facility (B) to point (G) represent interception true course and ground speed. If necessary, this line is extended until it crosses the projected true course of the distressed aircraft (H)
- the distance to intercept the intended track of the distressed aircraft is measured between the original position of the SAR aircraft facility (B) and the point at which the interception true course crosses the projected true course of the distressed aircraft (H)

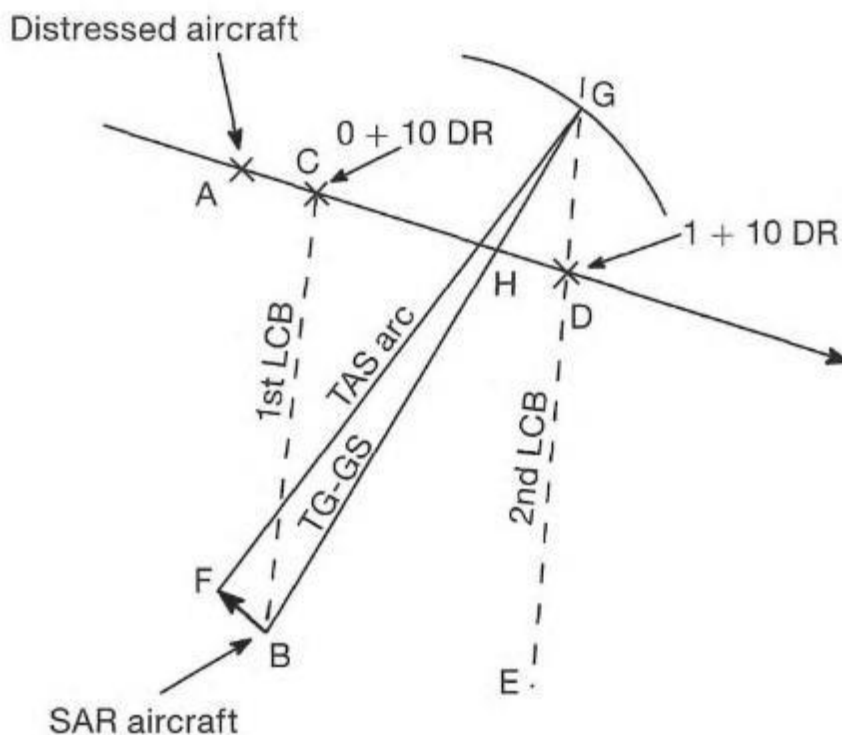

Offset or beam-on intercept: method 2

- the en-route time for this distance and closure time for the lead distance are computed and added to determine total time required for collision point intercept with the distressed aircraft
- depending on the speed differential, the SAR aircraft facility may execute a turn to the reciprocal of the track of the distressed aircraft when the course of the distressed aircraft has been intercepted
- interception of the course of the distressed aircraft can be confirmed by DF from the distressed aircraft.

Method 3 (using direction-finding equipment):

- This procedure requires that the SAR aircraft facility have DF equipment that can receive transmission from the distressed aircraft, and is executed as shown in the following figure, using magnetic bearings.
 - determine the bearing to the distressed aircraft, turn the SAR aircraft facility to a heading 45° from this bearing in the direction the distressed aircraft is flying moving.
 - maintain a relative bearing of 45° by checking DF bearings

- if the DF check reveals that the bearing from the SAR aircraft facility has increased, the interception course should be increased twice the amount of the change between the last two bearings
- if the check reveals that the bearing from the SAR aircraft facility has decreased, the interception course should be decreased twice the amount of change between the last two bearings
- by bracketing the bearings as described above, an interception course is determined, maintaining a line of constant bearing.

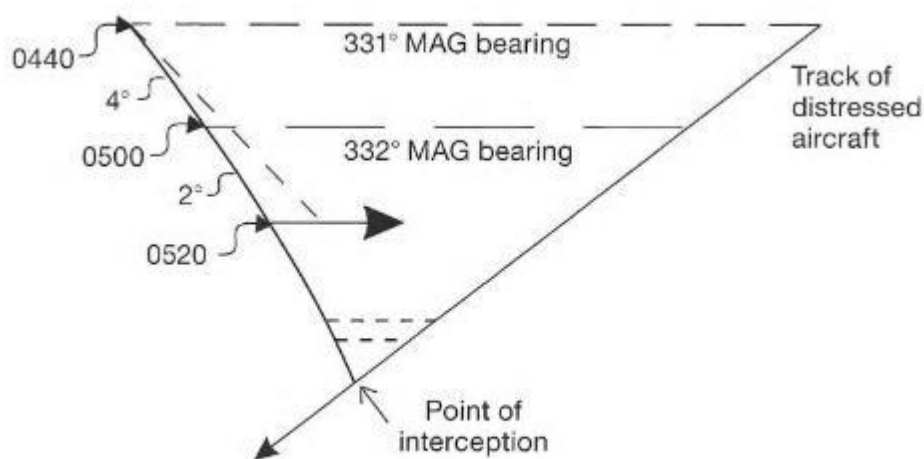

Offset or beam-on intercept: method 3

Aircraft intercepts

When visual contact has been made, the intercepting aircraft will normally take up a position slightly above, behind and to the left of the distressed craft.

Minimum time-to-scene intercept (MTTSI)

- This procedure was developed to intercept and escort higher-speed aircraft with lower-speed aircraft SRUs.
 - because of speed differential, it may be necessary for the SRU aircraft to turn short of the interception point on the distressed aircraft track to minimize the time-to-scene (provide maximum rescue availability) over the remaining distance to be flown
 - compute the SRU's maximum operating distance
 - compute the time to launch the SRU
 - compute the time at which the SRU should turn around (time-to-turn or TTT) and allow the distressed aircraft to begin overtaking it
 - when the SRU reaches the turn-around point, its time-to-scene from there to the distressed aircraft's position should equal the SRU's remaining time to the destination at the time the distressed aircraft lands

- keep the distressed aircraft informed of the type and the status of the interception being performed.
- The MTTSI should be used when all of the following conditions exist:
 - the distressed aircraft is not, nor expected to be, in immediate danger of ditching, crash landing, or bailout before it reaches the SRU's maximum operating distance
 - the SRU will depart and return to the same aerodrome that is the distressed aircraft's destination
 - the SRU's true air speed is less than that of the distressed aircraft
 - the position of the distressed aircraft is accurately known and it is proceeding from that location directly to the aerodrome from which the SRU will be launched.
- The SRU's maximum operating distance is computed as follows:
 - subtract the required fuel reserve time and the estimated time required on-scene from the SRU's maximum endurance to get the maximum operational endurance
 - the SRU's maximum operating distance is found by using the formula:

$$D_{mo} = \frac{T_{mo} V_{a1} V_{a2}}{V_{a1} + V_{a2}}$$

where:

D_{mo} = maximum operating distance in nautical miles

T_{mo} = maximum operational endurance in hours

V_{a1} = ground speed of SRU aircraft, outbound to intercept, in knots

V_{a2} = ground speed of SRU aircraft, inbound after ~~turn~~ turn, in knots

- for distressed aircraft beyond the SRU's maximum operating distance, the SRU's launch time is computed using the following formula:

$$T_0 = 60 \left(\frac{D}{V_b} - D_{mo} \frac{V_{a1}^2 + 2V_{a1}V_{a2} + V_{a2}V_b}{V_{a1}V_b(V_{a1} + V_{a2})} \right)$$

where:

T_0 = time to launch, in minutes, after the emergency was declared

D = distance, in NM, of the distressed aircraft from the aerodrome when the emergency was declared

V_b = ground speed of the distressed aircraft in knots

Note: If the computed value of T_0 is negative, the SRU may be launched immediately.

- The distance of the distressed aircraft from the aerodrome when the SRU is launched is given by:

$$D_0 = D - T_l \times V_b$$

60

where:

D_0 = The distressed aircraft's distance from the aerodrome at the time the SRU is launched

T_l = The time the SRU is launched, in minutes, after the emergency was declared.

- the time to turn, in minutes after SRU launch, is computed using the following formula:

$$T_{at} = \frac{60D_0V_{a2}(V_{a1} + V_b)}{V_b(V_{a1}^2 + 2V_{a1}V_{a2} + V_{a2}V_b)}$$

where:

T_{at} = ~~time to turn, in minutes, after the SRU's launch time~~ the time in minutes after launch when the SRU should turn back toward the aerodrome.

D_0 = distance, in NM, of the distressed aircraft from the aerodrome when the SRU is launched.

Section 20 – Survivors

Section contents

Immediate care of survivors

Recording information on survivors

Debriefing of survivors

Immediate care of survivors

- Once on board, medical care and welfare of the survivors should be attended to. Additional assistance should be sought from the SAR authorities as required.
- Medical advice should be sought from the Telemedical Maritime Advice Service, via the RCC. See section 3.
- After a rescue, survivors may require hospital treatment.
- They must be delivered to a place of safety as quickly as possible.
- The SMC should be advised if ambulances are needed.
- SAR personnel should be alert and ensure that, after rescue, survivors are not to be left alone, particularly if injured or showing signs of physical or mental exhaustion.
- When survivors are delivered to a hospital, the person in charge of the delivering facility should provide information on all initial medical treatment given to the survivors.

Recording information on survivors

- Survivor information should include:
 - type of injury suffered by the patient
 - describe serious injury
 - describe secondary injuries
 - how the injury occurred
 - the history of the most serious injury may give valuable insight into the nature and extent of injuries which may not be noticed otherwise
 - past medical history
 - includes previous surgery
 - congenital defects
 - illnesses, allergies
 - medication taken

- results of a full secondary assessment, including
 - vital signs
 - other signs
 - symptoms
- treatment given
 - particularly morphine and similar narcotic drugs
 - amounts and times administered
- times when tourniquets, splints, or compress bandages were applied
- for stretcher cases, this information should be noted and placed in a waterproof pouch, and securely attached to the survivor
- medical records pertaining to the survivor should be delivered to the hospital as soon as possible.

Debriefing of survivors

- Survivors should be questioned about the distressed craft as soon as possible. Their input may be able to further assist in the SAR operation, future SAR operations, or the prevention of incidents in the future. The information should be relayed to the SMC.
- Questions to ask include the following:
 - What was the time and date of the incident?
 - What was the last known position?
 - What was the total number of persons on board prior to the accident?
 - What caused the emergency?
 - Were any of the persons able to leave by lifeboat or raft?
 - How many survivors did you see in the water?
 - What flotation gear did they have?
 - If you were in the water, how long for?
 - Were search craft seen before the survivors were located and, if so, what were the dates and times of the sightings?
 - Were any signals or devices used to try to attract the attention of search craft? If so, what were they and when were they used?
- In addition, for aircraft incidents:
 - Did you bail out or was the aircraft ditched?
 - If you bailed out, at what altitude?
 - How many others did you see leave the aircraft by parachute?
 - How many ditched with the aircraft?
 - How many did you see leave the aircraft after ditching?

- Survivors should also be questioned about their medical history:
 - recurring disease
 - heart trouble
 - diabetes
 - epilepsy
 - conditions from which they may suffer.
- This information should be noted, together with any medical attention given, for future attending physicians.
- Questioning survivors has many purposes.
 - to ensure that all survivors are rescued
 - to attend to the physical welfare of each survivor
 - to obtain information which may assist and improve SAR services.
- Care must be taken to avoid worsening a survivor's condition by excessive interrogation.
- If the survivor is frightened or excited, the questioner should assess these statements carefully.

Note: Questions should be asked in a calm voice and the questioner should avoid suggesting answers to the survivor. Explain that the information required is for the success of the SAR operation and may be of great value for future SAR operations.

Section 21 – Deceased persons

Section contents

Handling of deceased persons

Handling of deceased persons

- Searching for and recovering bodies is not normally considered to be part of SAR operations. However, handling of human remains may at times be necessary.
- Human remains at an aircraft crash site should not be disturbed or removed without authorization except for compelling reasons.
- Without exposing rescuers to danger, an attempt should be made to identify deceased persons. All articles removed from or found near each body must be kept separate, preferably in a container so labelled that it can be correlated later with the body. All these articles should be handed over to the proper authority as soon as possible.
- When human remains are recovered during a SAR operation, or when a death occurs on board a SAR facility, a waybill should be made out for each deceased person. It should contain the full name and age of the deceased (if known), as well as the place, date, time, and cause of death (if possible). This waybill should be made out in the national language of the SAR facility and, wherever possible, in English.
- Considerations for the transport of human remains include:
 - on vessels, body bags or sailcloth for human remains should be carried. (If human remains are kept on board for any length of time, they should be properly wrapped and put in a suitable place on the vessel.)
 - SAR aircraft do not normally transport human remains. (However, SAR aircraft may have to carry human remains if no other means are readily available.)
 - immediately after return to a base specified by the RCC, the remains must be handed over to the appropriate authorities, accompanied by the waybill
 - if it is known or suspected that a deceased person had an infectious disease, all material and objects which have been in direct contact with the deceased person must be cleaned and disinfected or destroyed.

Section 22 – Public relations

Section contents

Contact with the media

Contact with the media

- A SAR operation often creates great interest with relatives of the victims, the general public, and with radio, television, and newspapers. Contacts with the media are normally the responsibility of the RCC or higher authority.
- The media may be waiting when the rescue facility returns to its base or reaches its next destination, and may sometimes arrange to conduct interviews over radio links. In such situations where there will be contact with the media, a rescue facility spokesperson should be designated. That person should exercise good judgement and avoid:
 - personal judgements or demeaning information on the:
 - crew or missing persons
 - judgement, experience, or training of the pilot-in-command, captain, or the crew
 - degrading opinions on the conduct of the SAR operations (only factual information should be given)
 - personal opinions or theories as to why the accident occurred or how it could have been avoided
 - giving names of missing or distressed persons until every effort has been made to inform the relatives
 - giving the name of the operator or the owner of the aircraft, ship, or other craft before they have been informed
 - revealing names of persons who have given information related to the case.
- The rescue facility spokesperson should refer any request for personal opinions, comments on departmental policies, search rationale or sensitive matters to the appropriate RCC and/or higher authority.
- On the other hand, the type of information that the RCC spokesman ~~person~~ could release, depending on the specific circumstances of the SAR operation, includes, but is not limited to:
 - general reason for the SAR operation
 - type of aircraft or vessel involved
 - owner/operator of the aircraft or vessel (only after the owner/operator has been informed and given consent)
 - name of vessel / flight number (only after the owner/operator has been informed and ~~has~~ given consent)
 - number of people on board
 - general area being searched
 - number and types of aircraft and vessels engaged in the search and the number of hours ~~flown~~ engaged
 - arrangements for search at sea or on land (as applicable)
 - details of other authorities participating in the search

- contact number for use by the next of kin to obtain information
- contact number for further information
- contact number for media enquiries.

Section 23 – Training

Section contents

Search and rescue personnel

Air search and rescue facilities

Maritime search and rescue facilities

Masters and officers of merchant ships

Land search and rescue facilities

Pararescue and paramedical personnel

Depot personnel

Search and rescue personnel

- Training of search and rescue personnel can include:
 - study of the application of SAR procedures, techniques, and equipment through lectures, practical demonstrations, films, SAR manuals, and journals
 - assisting in or observing actual operations
 - exercises in which personnel are trained to coordinate individual techniques and procedures in a simulated operation.

Air search and rescue facilities

- In addition to normal flying programmes, each crew member should be given specialized experience in SAR techniques for that member's particular function and the type of aircraft.
- All crew members assigned to SAR duties should be familiar with the following:
 - air–surface coordination in SAR operations
 - signal codes and signalling methods used by surface craft and survivors
 - scanning and spotting techniques
 - action to be taken when sighting a distress scene
 - first aid.

Pilots

- Pilot training programmes should be aimed at developing one or more of the following techniques as appropriate to the type of operation involved:
 - precision in flying search patterns, maintaining tracks and height
 - flying at low levels as applicable to normal searches or to contour searches
 - dropping of supplies (selection of approach heading and height, judgement of release point)
 - intercepting and escorting aircraft
 - assistance to ditching aircraft
 - landing and take-off from confined areas
 - winching by helicopters.

Navigators

- Accurate navigation and continued knowledge of position within narrow limits is required, often in areas with no or few navigation aids.

Observers

- The observer (or look-out) performs a very important function and should preferably have aircrew experience; an untrained observer seriously reduces the efficiency of an air search.
- In addition to continued flight experience, personnel with observer duties should be given training on the following:
 - sufficient flying time for:
 - aircraft familiarization
 - familiarity with the terrain of likely search areas
 - knowledge of day and night scanning procedures
 - acquiring the ability to detect objects from the air under monotonous conditions for prolonged periods of time
 - knowledge of the appearance from the air of:
 - aircraft wreckage and associated marks (e.g. slash marks in standing timber, burnt-out areas, skid marks, or scattered pieces of wreckage.)
 - liferaft, lifeboat, dye marker trails, a person in the water
 - knowledge of supply dropping procedures.
- If extensive flying training is not practicable, the use of films, photographs and information circulars describing general procedures for observers may prepare observers for their task.
- Appendix C discusses factors affecting observer effectiveness.

Supply droppers

- Personnel responsible for the dropping of supplies from aircraft should be familiar with:
 - stowage and handling of supply containers and parachutes
 - safety precautions during dropping operations
 - dropping techniques.

Maritime search and rescue facilities

Crew members

- Every opportunity should be taken to supplement training with SAR exercises as follows:
 - coordinated air–surface SAR operations
 - provision of assistance to aircraft (homing, communication, ditching)

- knowledge of signalling methods and codes
- handling of all types of survival craft and equipment
- storage and maintenance of special equipment
- removal of survivors from ships, other craft, survival craft, and the sea
- first aid, artificial respiration, general care of survivors and the injured
- fire-fighting methods and associated equipment.

Deck officers

- Training of deck officers should include all training required for crew members plus:

Organization

- knowledge of the SAR organization
- knowledge of available SAR facilities, including those of adjacent SRRs
- knowledge of legal aspects, particularly as regards to towing and salvage, etc.

Procedures

- search patterns and techniques for air and surface facilities
- communication procedures
- rescue procedures
- supply dropping procedures
- ditching assistance, stand-by and escort procedures
- debriefing of survivors

Seamanship

- navigation in difficult conditions close inshore or at sea and in close proximity to disabled vessels
- use and understanding of all electronic navigational equipment used on SAR craft, including their accuracy and limitations
- proper use of radar
- knowledge of charts, sailing directions, buoys, lights, and aids to navigation in the SRR
- use of publications on tides and currents relating to the SRR and the calculations of tidal conditions, as applicable

- use of weather and wave charts, pilot charts
- estimating the drift of survival craft
- methods of calculating the point of interception
- methods of recovery of survivors both close inshore and in the open sea from all kinds of craft in adverse weather conditions
- good seamanship
- methods of calculating search patterns.

Radio operators

- All radio operators must be qualified in accordance with Article 55 of the ITU Radio Regulations for operating the specific equipment with which individual SAR craft are fitted.
- Additional training should include:
 - SAR communications procedures and regional communications plans
 - knowledge of communications facilities existing within the SRR and adjacent SRRs
 - an understanding of the practical difficulties which may be associated with ship–aircraft communications and possible methods of overcoming these conditions
 - knowledge of procedures for exchange of information with SAR surface craft and with the shore
 - knowledge of available operating frequencies for the SRR.

Look-outs

- Keeping a good look-out is a most important function, given the limited range of vision from surface craft and difficulty in locating objects and persons in the sea.
- Masters, commanding officers, and watch standing officers must be trained in properly briefing look-outs in their duties and the harmful effects of fatigue on the look-out.
- Training should include:
 - knowledge of distress signals
 - scanning methods and reporting sightings
 - signs of sunken ship or aircraft; for example, oil slicks or wreckage
 - relative range of detection for various types of search objects.
- Appendix C discusses factors affecting observer (look-out) effectiveness.

Crews of rescue boats

- Rescue boat crews should be trained in all duties that they could be called upon to perform.

First aid

- Regular training in first aid should consist of formal instruction, demonstration, and exercises, given by qualified emergency medical personnel.
- Appropriate training aids should be used and copies of a first aid manual should be issued. The syllabus should include, as appropriate, depending on equipment available:
 - use of rescue lifting systems and other devices for removing survivors from water
 - fundamental first aid, with emphasis on revival of the partially drowned and treatment for shock, prolonged immersion, hypothermia, and burns
 - cardiopulmonary resuscitation (CPR)
 - use of automated external defibrillators (AEDs)
 - administration of oxygen.
- Attention is also drawn to the guidance on first aid given in IMO's Pocket Guide for Cold Water Survival.

Masters and officers of merchant ships

- The mandatory minimum requirements for the training of masters of merchant ships in SAR operations are contained in the International Convention on Standards of Training, Certification and Watchkeeping for Seafarers, 1978, as amended.

Land search and rescue facilities

- Land facilities are normally established from groups whose members have special qualifications for operating in the type of terrain prevalent in their area.
- Additional training may be needed (such as search techniques, first aid, and radio communication procedures.)
- When staffed by volunteers whose only qualification is physical fitness, then training should be provided on:
 - familiarity with the terrain in which operations will be conducted and SAR methods and techniques to be employed
 - map reading and the use of a magnetic compass
 - ability to operate by day and night in all weather conditions with little outside help
 - knowledge of supply-dropping techniques

- preparation of airstrips or clearings for helicopters
 - air–surface coordination in SAR operations
 - knowledge of fire prevention and fire-fighting methods in aircraft and aircraft wrecks
 - knowledge of safety requirements for working around and within aircraft wreck sites
 - knowledge of signalling methods and codes
 - operation and maintenance of special equipment
 - evacuation of survivors and injured
 - first aid and general care of survivors.
- Land rescue personnel should be specially instructed concerning the removal of survivors and human remains from crashed aircraft.
 - knowledge of the position in the wreckage of both survivors and bodies may be of vital importance to the accident investigation
 - rescue personnel should be taught to make every effort to preserve such evidence to the maximum extent possible (such as photography)
 - Training in medical aspects should consist of formal instruction, demonstrations and exercises, given and supervised by a competent instructor, e.g. a doctor or qualified emergency medical personnel. Manuals on initial medical assistance should be issued to the trainees. Training should include fundamental first aid and general care of survivors, including treatment for exposure. It should be stressed that medical advice should be obtained before the evacuation of seriously injured survivors.

Pararescue and paramedical personnel

- In addition to training in parachute-jumping techniques and procedures, pararescue and paramedical personnel should also be trained as members of a land facility.
- Pararescue and paramedical units should be able to make precision landings with minimum dispersal of the group and without injuring themselves or damaging or losing equipment. They should develop skills in:
 - accurate estimation of exit points from various altitudes
 - execution of jumps into various types of land and water areas in different weather conditions
 - descent from trees with or without the aid of ropes or other let-down devices
 - swimming and the use of one-person liferafts
 - diving equipment.

- Practice jumps should be supervised by an experienced parachutist and the pilot of the aircraft should have experience as a pilot of an aircraft carrying parachutists. The following precautions should be observed:
 - the aircraft used should be approved for the carrying of parachutists
 - the supervisor should check that each person is correctly dressed and equipped:
 - proper parachute suits, jump-boots, and helmets are worn
 - harnesses, parachutes, and (if carried) rescue packs are correctly fitted
 - reserve chutes are worn
 - rigid face guards are worn for jumps in timber or bush-land and sufficient rope is carried to permit descent from trees
 - lifejackets are worn for jumps near or into water
 - wind speed or wind gusts must not exceed the limits specified for the parachute
 - the jumping point should be determined by the supervisor after dropping a pilot chute or a streamer to determine drift
 - jumps should not be made in close proximity to runways or other hard surfaces
 - the jump height should not be less than the altitude required to effect a safe landing under a reserve parachute in the event the main parachute fails to properly open.

Depot personnel

- At each depot, adequately trained personnel should be assigned to maintain, inspect, pack, and repack liferafts, parachutes, containers, and packs of survival stores and to carry out periodic inspections.
- Depot personnel training should include, where necessary:
 - fitting parachutes to containers, liferafts, etc.
 - joining containers and liferafts for combined drops
 - loading and securing supplies on board aircraft and surface craft
 - stocktaking and replenishing supplies
 - inspections.

Appendix C

Amend the text in two places on page C-2 as follows:

Limitations of the eye,

10th dot point, remove "target" and replace with IAMSAR term "search object":

if a ~~target~~ search object is visible to only one eye, ...

12th dot point: Glare, usually worse on a sunny day, makes ~~targets~~ search objects hard to see...

Appendix H

Multiple aircraft SAR operations

ACO procedure form – Mass rescue Multiple aircraft SAR operations

GENERAL INFORMATION	
OPERATION	
EMERGENCY LOCATION	
IDENTIFICATION (VERSION)	
TIME ZONE	
ACO INFORMATION	
ACO CALLSIGN	
ACO FREQUENCY	
ACO TEL/EMAIL	
WAYPOINTS	
REFERENCE POINT	
ENTRY POINT	
FINAL APPROACH POINT	
EXIT POINT	
HOLDING POINT 1	
HOLDING POINT 2	
EVACUATION SITE 1	
EVACUATION SITE 2	
REFUELING	
CREW SUPPORT	
ALTITUDES	
ENROUTE/ENTRY	
HOLDING POINT(S)	
FINAL APPROACH POINT	
EXIT POINT	
MISSED APPROACH. APPROACH Fallback PROCEDURE	
ENROUTE/LEAVING AREA	
NATURE OF DISTRESS AND/OR SEARCH OBJECTS	
SAFETY BRIEF	
<p><i>"The Air Coordinator will only provide advisory information. You (Pilot-in-command) are responsible for the safety of your own aircraft at all times. If you, because of safety reasons, are unable to comply with instructions given by ACO, you are to notify me (ACO) immediately."</i></p>	

PICTURE OF ACO PROCEDURE	
MISSED APPROACH PROCEDURE APPROACH FALLBACK PROCEDURE	
HOIST POSITIONS ON SCENE	
WEATHER ON SCENE	QNH

Pilot Information File

AIR COORDINATOR 123,100 MHz

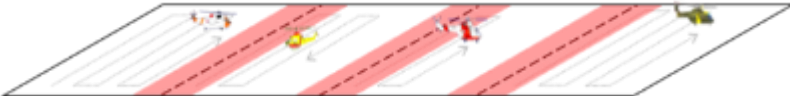
ENTRY REPORT / 20 NM before reaching area!	
10.	Callsign
11.	Nationality
12.	Type (FIXED/HELICOPTER AND TYPE)
13.	Position
14.	Altitude and pressure setting
15.	ETA (RELEVANT POINT OR SEARCH AREA)
16.	Endurance on scene
17.	Remarks (EQUIPMENT – LIMITATIONS)
18.	POB (crew, other personnel)
REPORTING	
<ul style="list-style-type: none">• Reaching assigned points.• Leaving assigned points.• Commencing operations (search, investigation during search, approach to surface/ship, missed approach fallback procedure, hoist, landing etc.).• Completing operations, including information regarding results.• Leaving present altitude.• Reaching new altitude.• 10 minutes to completing hoist operation or search.• 30 minutes on scene endurance, expecting fuel at (location)• Exit Report: PAX, ETA and requirements at destination, ETA back in operations area and any remarks (hoist position and weather)	
SEARCH MISSION	
	
<ul style="list-style-type: none">• Coordination zones – example 1 NM on each side of border Call neighbouring helo: before entering coordination zone +when exiting 1NM buffer2. No fly zones: Do not enter buffer zone.	
<p>NOTE: The ACO provides only ADVISORY information, pilots-in-command aircraft commanders are responsible for the safety of own aircraft. Notify ACO immediately if unable to comply with instructions received.</p>	