

標題

MSC 96 の審議結果の紹介

ClassNK

テクニカル インフォメーション

No. TEC-1090
発行日 2016年9月27日

各位

2016年5月11日から20日にIMO(英国・ロンドン)において第96回海上安全委員会(MSC 96)が開催されました。今般、IMOよりMSC 96の議事録及び決議並びにサーキュラーが発行されたことから、次の通り同会合の情報及び審議結果をお知らせ致します。

1. 採択された義務要件

今回の会合で採択された主要な義務要件は以下の通りです。

(1) 救命艇等の整備の適正化 (添付 1、3 参照)

救命艇、救助艇、進水装置等の保守、作動試験、整備要件等を規定した MSC 決議及び同決議を強制化するための SOLAS 条約 III 章 3 規則及び 20 規則の改正が採択されました。

適用: 2020年1月1日発効

(2) ヘリコプター甲板及びヘリコプター着陸区域に対する泡消火装置 (添付 2、3、5 参照)

SOLAS 条約 II-2 章 3 規則に定義されるヘリコプター甲板及びヘリコプターが臨時または緊急に着陸するヘリコプター着陸区域に対する泡消火設備の要件を規定した FSS コード 17 章の新設、及び同章を強制化するための SOLAS 条約 II-2 章 18 規則が採択されました。また、併せて同 FSS コードの改正を取り入れるための 2009MODU コード(推奨要件)第 9 章の改正も採択されました。

適用: 2020年1月1日以降の起工船

(3) 旅客船の避難解析 (添付 3、17 参照)

現行の SOLAS 条約において、1999年7月1日以降に起工したロールオン・ロールオフ旅客船に対し、脱出経路の避難解析が要求されています。今回の会合において、ロールオン・ロールオフ旅客船に加え、36人を超える旅客船に対し避難解析の実施を強制化する SOLAS 条約 II-2 章 13 規則の改正が採択されました。また、避難解析の適用拡大に伴い、避難解析の手法を定めた避難解析ガイドライン(MSC.1/Circ.1238)の改正も承認されました。(下記 3.2.(3)を参照)

適用: ロールオン・ロールオフ旅客船

定員 36人を超えるその他の旅客船で、2020年1月1日以降に起工する船舶

(次頁に続く)

NOTES:

- ClassNK テクニカル・インフォメーションは、あくまで最新情報の提供のみを目的として発行しています。
- ClassNK 及びその役員、職員、代理もしくは委託事業者のいずれも、掲載情報の正確性及びその情報の利用あるいは依存により発生する、いかなる損失及び費用についても責任は負いかねます。
- バックナンバーは ClassNK インターネット・ホームページ(URL: www.classnk.or.jp)においてご覧いただけます。

- (4) 自動スプリンクラーの水質管理 (添付 2 参照)
自動スプリンクラーの管内腐食や閉塞を防ぐための水質管理を規定する FSS コード 8 章の改正が採択されました。

適用: 2020 年 1 月 1 日発効

- (5) IMDG コードの改正
国連の危険物輸送・分類調和専門委員会第 7 回会合(2014 年 12 月)にて合意された国連 Model Regulation(オレンジブック)の改正への対応を含む、IMDG コードの第 38 回改正が採択されました。

適用: 2018 年 1 月 1 日発効

- (6) ESP コードの改正 (添付 4 参照)
ばら積貨物船及び油タンカーに対する検査強化プログラムを規定する 2011ESP コードは、IACS UR Z10 シリーズの改正と整合を図るために継続的に改正が行われています。今回の会合において、閉囲区域の立ち入りに関する勧告(決議 A.1050(27))を取り入れた 2011ESP コードの改正が採択されました。

適用: 2018 年 1 月 1 日発効

2. 今回承認された義務要件

以下の改正案は、本年 11 月に開催される MSC 97 にて採択される見込みです。

- (1) ボイラー室に要求される泡消火器 (添付 6 参照)
ボイラー室に設置が要求されている 135L の泡消火器に関し、固定式水系局所消火装置が設置されているボイラー室については、これを免除できる SOLAS 条約 II-2 章 10.5 規則の改正が承認されました。

- (2) SOLAS 条約 II-1 章の改正 (添付 9 参照)
区画及び損傷時復原性に関する SOLAS 条約 II-1 章の改正案が承認されました。主な改正内容は以下の通りです。

- (i) 旅客船の要求区画指数 R (6 規則)
旅客船の要求区画指数 R を、旅客数 1000 人以下、1000~6000 人、6000 人超の 3 ケースに応じたクライテリアとする改訂。
- (ii) 二重底に設けられるウェル (9 規則)
旅客船及びタンカー以外の貨物船の二重底に設けられるウェルについて、ウェルの底からキール線に一致する面までの距離は、500mm もしくは要求される二重底高さの半分の高さのいずれか大きい方以上とし、満足しない場合には、9.8 規則の船底損傷時復原性計算を満足することを要求する改訂。

(次頁に続く)

- (iii) 貨物船の船首隔壁弁へのバタフライ弁の使用 (12 規則)
貨物船の船首隔壁弁へのねじ下げ弁の使用に関し、バタフライ弁の使用を認める改訂。ただし、バタフライ弁は弁座またはフランジで適切に支持され、乾舷甲板上から操作できなければならない。
- (iv) 旅客船に対する損傷制御訓練の実施 (19-1 規則)
全ての旅客船に対し、損傷制御訓練に含めるべき内容を規定し、定期的な損傷制御訓練の実施を要求する改訂。
- (3) 液化ガス運搬船の船橋の窓に対する防火構造の要件 (添付 8 参照)
貨物区域に面する船橋の窓に A-0 級防火構造を要求する規定を削除する IGC コード 3 章 3.2.5 の改正が承認されました。
- (4) Non-ESP 船と ESP 船の検査期間の調和 (添付 7 参照)
Non-ESP 船の検査期間を ESP 船の検査期間と調和させるための SOLAS 条約 XI-1 章 2-1 規則を新たに追加した SOLAS 条約の改正案が承認されました。
- (5) 船内騒音コードの適用に関する SOLAS 条約 II-1 章の改正 (添付 9、22 参照)
2018 年 7 月 1 日より前に引渡しが行われる船舶で、建造契約日が 2014 年 7 月 1 日より前であり、かつ起工日が 2015 年 1 月 1 日以降の場合、新コードの MSC.337(91)と旧コードの A.468(XII)のいずれも適用されないため、当該船舶に旧コードを適用させるための SOLAS 条約 II-1 章 3-12 規則の改正が承認されました。本改正の承認に加え、同改正が発効するまでの暫定的措置として、同改正内容を記載した船内騒音コードの適用に関するガイダンスが MSC.1/Circ.1547 として承認されました。
3. 今回の会合において承認された主な統一解釈及びガイドラインは、以下のとおりです。以下で参照されている IACS 統一解釈 (UI) については、弊会のホームページ (<http://www.classnk.or.jp/>) 又は IACS ホームページ (<http://www.iacs.org.uk/>) に公開しています。

3.1 統一解釈

(1) SOLAS 条約 II-2 章に関する統一解釈 (添付 13 参照)

- ・ エンジン、タービン、ギアボックス設備における鋼以外の材料の適用に関する解釈
- ・ 油タンカーの二重船側及び二重底への設置が要求される固定式炭化水素ガス検知装置の設置場所に関する解釈 (UI SC268 を基に作成)
- ・ 鋼以外の材料の通風ダクトを鋼製の通風ダクトと同等とみなすための解釈 (UI SC264 を基に作成)

(次頁に続く)

- (2) FSS コードの 5、6、9 章に関する統一解釈 (添付 14 参照)
- FSS コード 5 章 2.2.1.7 規則にて規定される炭酸ガスを三段階で放出できる制御装置に関し、その放出量は各貨物区域の容積ではなく、最大の貨物区域の容積を基準とする解釈
 - 高膨張泡消火装置に関し、A 類機関区域において保護される最大区画の範囲に関する解釈(UI SC262 を基に作成)
 - 固定式火災探知警報装置の追加の表示盤の設置が要求される貨物制御室について、専用の貨物制御室以外の区画であっても貨物制御盤が備えられている区画を貨物制御室とみなす解釈。(UI SC271 を基に作成)
- (3) LSA コードの 4.4.7.6 に関する統一解釈 (添付 15 参照)
- LSA コードの 4.4.7.6 に規定する救命艇の離脱装置に関し、離脱機構、インターロック装置等のすべての部品に対する海洋環境下における耐食性要件等を明確にする解釈(UI SC267 を基に作成)
 - 耐食試験の実施要否の基準となる孔食指数値の修正(UI SC267 を基に作成)
- (4) SOLAS 条約 III 章 6.4,6.5 規則及び LSA コード 7.2 に関する統一解釈 (添付 16 参照)
- 一般非常警報と船内通報装置の音圧及び設置要件を明確にする解釈
- (5) Load Lines 条約に関する統一解釈 (添付 18 参照)
- 倉口、扉及び通風筒の縁材高さを決定するにあたっての位置 I 及び位置 II の定義における高さ方向の上限及び甲板室等の暴露甲板の取扱い等を明確にする解釈
- (6) SOLAS 条約 II-1 章 29.3、29.4 規則に関する統一解釈 (添付 19 参照)
- 海上試運転における操舵試験を最大航海喫水状態において実施できない場合に行うべき舵力及びトルクの推定について、他の喫水状態において実施した操舵試験での計測データを基に算式により外挿計算する旨等を定める解釈(UI SC246 を基に作成)
- (7) SOLAS 条約 II-1 章に関する統一解釈 (添付 20 参照)
- 船上に貯蔵される固定式消火装置の消火剤(清水、炭酸ガス、ドライケミカル粉末及び泡原液等)の重量を軽荷重量及び軽荷状態に含める解釈 (UI SC273 を基に作成)
 - 純トン数に含まれるタンク、旅客船の雑排水及び汚水を積載する兼用タンク、家畜運搬船の家畜排泄物を積載する兼用タンクは、当該タンクの塗装が塗装メーカーの手順に従い施工されることを条件に PSPC が適用されないことを明確にする解釈
 - 運航中に機関室及び非常用発電機室に空気を供給するために開放状態とする通風筒は、復原性計算において風雨密に閉鎖することのできない開口とみなす解釈

(次頁に続く)

- (8) SOLAS 条約 II-1 章 3-6 規則の適用に関連する統一解釈 (添付 21 参照)
- ・ ばら積み貨物船及び油タンカーの固定点検設備に関し、貨物倉内等に設けられた隣接する垂直梯子の間隔等を明確にする解釈 (UISC191 を基に作成)

3.2 ガイドライン

- (1) 極海における運航制限評価法に関するガイダンス (添付 11 参照)
- ・ 極海における航海予定海域において遭遇する氷の種類やアイスクラスに基づくリスク評価を行い、船舶の航行制限を検討するためのガイダンス。
- (2) 船舶のサイバーリスクマネージメントに関する暫定ガイドライン (添付 12 参照)
- ・ サイバーリスク管理のために考慮すべき機能要素を示した非強制ガイドライン。下記 4.(2)をご参照下さい。
- (3) 旅客船の避難解析に関するガイドライン (添付 17 参照)
- ・ 旅客船に対し、総退船時間を算出するための避難解析の手法及びその許容時間を示したガイドライン。

4. その他

(1) GBS (添付 10 参照)

油タンカー及びばら積貨物船を対象とする新造船の構造に関する GBS は、2004 年の MSC 78 から検討が開始されました。2010 年 5 月の MSC 87 において、GBS 及び GBS を導入するための SOLAS 条約の改正が採択されました。

適用対象は、船の長さが 150m 以上の油タンカー及びばら積貨物船のうち、2016 年 7 月 1 日以降に建造契約が結ばれる船舶、建造契約がない場合は 2017 年 7 月 1 日以降に起工または同様の建造段階にある船舶、または 2020 年 7 月 1 日以降に引渡しが行われる船舶です。これらの対象船舶を設計・建造する場合、IMO が GBS に適合していると確認した船級協会の規則に従う必要があります。IACS メンバーの各船級協会規則が、GBS に適合していることを検証するための監査が、2014 年 3 月から 2015 年 7 月までの間に実施されました。また、IACS 及びそのメンバー協会は、当該監査における指摘事項に対する是正処置計画を 2015 年 12 月に提出しました。

今回の会合にて、監査報告書及び IACS の是正処置計画等について審議を行った結果、IACS メンバーの各船級協会規則が GBS に適合していることが確認されました。また、2016 年 7 月 1 日以降に建造契約され、これらの規則に従って建造された船舶は SOLAS 条約の GBS 要件に適合していると判断すべきことも合意されました。なお、MSC 96 の審議結果を公表するための MSC.1/Circ.1518 が発行されました。

(次頁に続く)

(2) サイバーセキュリティ (添付 12 参照)

近年の情報通信技術の発達に伴い、陸上分野のみならず海事分野においてもサイバーシステムの導入が進んでおり、今後は船陸間の電子情報の通信及び共有が加速していくことが予想されております。一方、陸上分野においては、既にサイバーシステムの脆弱性を狙ったサイバー攻撃の事例が報告されていることから、海事分野においても、安全運航に関わる船舶システムへの不正アクセスなど、サイバーセキュリティの対策のための検討が IMO に対し求められていました。

今回の会合では、米国等からの共同提案、及びボルチック国際海運協議会(BIMCO)等の業界団体からサイバーセキュリティ対策に関するガイドライン案が提出されました。審議の結果、米国等が提案したガイドラインをベースとし、業界ガイドライン及び国際規格を盛り込んだ非強制のサイバーセキュリティ対策に関する暫定ガイドライン MSC.1/Circ.1526 が承認されました。同ガイドラインは、個々の機器やシステムに着目した詳細な要件を規定するものではなく、リスク解析を行った上で対策を検討するマネジメントベースの対応を求めるものとなっております。

(3) 今回会合における採択が見送られた要件

既に承認されている以下の改正案については、次回会合 (MSC 97) での採択に向けて検討されることが合意されました。

(i) アンカーハンドリング船の非損傷時復原性基準

アンカーハンドリング船の非損傷時復原性基準を取り入れる 2008 年非損傷時復原性コード (2008 IS コード) の改正案は、「吊り上げ及び曳航を行う船の非損傷時復原性基準」と併せて、次回会合 (MSC97) での採択に向けて検討されることが合意されました。

(ii) 極海を航行する船舶の乗組員の要件

極海を航行する船舶の船長及び航海士の要件を追加する STCW 条約及び STCW コードの改正案は、今回の会合で承認された旅客船の乗組員に対する安全訓練要件と併せて、次回会合 (MSC97) での採択に向けて検討されることが合意されました。なお、当該改正は 2018 年 7 月 1 日に発効する見通しです。

(次頁に続く)

なお、本件に関してご不明な点は、以下の部署にお問い合わせください。

一般財団法人 日本海事協会 (ClassNK)

本部 管理センター別館 国際部

住所: 東京都千代田区紀尾井町 3-3 (郵便番号 102-0094)

Tel.: 03-5226-2038

Fax: 03-5226-2734

E-mail: xad@classnk.or.jp

添付:

1. RESOLUTION MSC.402(96)
2. RESOLUTION MSC.403(96)
3. RESOLUTION MSC.404(96)
4. RESOLUTION MSC.405(96)
5. RESOLUTION MSC.407(96)
6. DRAFT AMENDMENTS TO SOLAS REGULATIONS II-2/1 AND II-2/10
7. DRAFT NEW SOLAS REGULATION XI-1/2-1
8. DRAFT AMENDMENTS TO THE IGC CODE
9. DRAFT AMENDMENTS TO SOLAS CHAPTER II-1
10. MSC.1/Circ.1518
11. MSC.1/Circ.1519
12. MSC.1/Circ.1526
13. MSC.1/Circ.1527
14. MSC.1/Circ.1528
15. MSC.1/Circ.1529
16. MSC.1/Circ.1530
17. MSC.1/Circ.1533
18. MSC.1/Circ.1534
19. MSC.1/Circ.1536
20. MSC.1/Circ.1539
21. MSC.1/Circ.1545
22. MSC.1/Circ.1547

ANNEX 1

RESOLUTION MSC.402(96) (adopted on 19 May 2016)

REQUIREMENTS FOR MAINTENANCE, THOROUGH EXAMINATION, OPERATIONAL TESTING, OVERHAUL AND REPAIR OF LIFEBOATS AND RESCUE BOATS, LAUNCHING APPLIANCES AND RELEASE GEAR

THE MARITIME SAFETY COMMITTEE,

RECALLING Article 28(b) of the Convention on the International Maritime Organization concerning the functions of the Committee,

RECALLING ALSO the *Measures to prevent accidents with lifeboats* (MSC.1/Circ.1206/Rev.1) and the *Interim recommendation on conditions for authorization of service providers for lifeboats, launching appliances and on-load release gear* (MSC.1/Circ.1277) approved by it,

RECOGNIZING the need to establish a uniform, safe and documented standard for maintenance, thorough examination, operational testing, overhaul and repair of lifeboats (including free-fall lifeboats) and rescue boats (including fast rescue boats), launching appliances and release gear,

NOTING that, by resolution MSC.404(96), it adopted amendments to regulations III/3 and III/20 of the International Convention for the Safety of Life at Sea, 1974 ("the Convention"), concerning maintenance, thorough examination, operational testing, overhaul and repair of lifeboats and rescue boats, launching appliances and release gear,

NOTING ALSO that the aforementioned regulation III/20 of the Convention provides that the maintenance, thorough examination, operational testing, overhaul and repair shall be carried out in accordance with the Requirements for maintenance, thorough examination, operational testing, overhaul and repair of lifeboats and rescue boats, launching appliances and release gear ("the Requirements"),

HAVING CONSIDERED, at its ninety-sixth session, the recommendation made by the Sub-Committee on Ship Systems and Equipment, at its third session,

1 ADOPTS the Requirements for maintenance, thorough examination, operational testing, overhaul and repair of lifeboats and rescue boats, launching appliances and release gear, the text of which is set out in the annex to the present resolution;

2 INVITES Contracting Governments to the Convention to note that the Requirements will take effect on 1 January 2020 upon entry into force of the associated amendments to regulations III/3 and III/20 of the Convention;

3 ALSO INVITES Contracting Governments to the Convention to take measures they consider appropriate to ensure that national manufacturers of equipment certified under chapter III of the Convention for installation and use on board ships undertake to ensure that equipment, instructions, specialized tools, spare parts, training and accessories, as required, are available to independent service providers in a timely and cost-effective manner;

4 REQUESTS the Secretary-General to transmit certified copies of this resolution and the text of the Requirements contained in the annex to all Contracting Governments to the Convention;

5 REQUESTS ALSO the Secretary-General to transmit copies of this resolution and the annex to all Members of the Organization which are not Contracting Governments to the Convention.

ANNEX

REQUIREMENTS FOR MAINTENANCE, THOROUGH EXAMINATION, OPERATIONAL TESTING, OVERHAUL AND REPAIR OF LIFEBOATS AND RESCUE BOATS, LAUNCHING APPLIANCES AND RELEASE GEAR

1 GENERAL

1.1 The objective of these Requirements for maintenance, thorough examination, operational testing, overhaul and repair of lifeboats and rescue boats, launching appliances and release gear (the Requirements) is to establish a uniform, safe and documented standard for maintenance, thorough examination, operational testing, overhaul and repair of the equipment specified in paragraph 2.1.

1.2 The detailed procedures covered by these Requirements are provided in section 6.

1.3 These Requirements relate to the following regulations:

- .1 SOLAS regulation III/20 – Operational readiness, maintenance and inspections; and
- .2 SOLAS regulation III/36 – Instructions for onboard maintenance.

1.4 The Company¹ shall ensure that maintenance, thorough examination, operational testing, overhaul and repair on board its ships is conducted in accordance with these Requirements and SOLAS regulation III/20. The Company shall establish and implement health, safety and environment (HSE) procedures covering all activities set out in these Requirements.

1.5 The personnel carrying out maintenance, thorough examination, operational testing overhaul and repair as described in paragraphs 4.2 and 4.3 shall be certified by an authorized service provider in accordance with the requirements specified in section 8. When performing such activities on board ships they shall comply with health, safety and environment (HSE) instructions and procedures established by the Company.

2 APPLICATION

2.1 These Requirements shall apply to the maintenance, thorough examination, operational testing, overhaul and repair of:

- .1 lifeboats (including free-fall lifeboats), rescue boats and fast rescue boats; and
- .2 launching appliances and on-load and off-load release gear for lifeboats (including primary and secondary means of launching appliances for free-fall lifeboats), rescue boats, fast rescue boats and davit-launched liferafts.

2.2 For the purpose of these Requirements:

- .1 *Authorized service provider* means an entity authorized by the Administration in accordance with section 3 and section 7.

¹ For the purpose of these Requirements, Company is as defined in SOLAS regulation IX/1.2.

- .2 *Equipment* means the aforementioned equipment to which the Requirements apply.
- .3 *Manufacturer* means the original equipment manufacturer or any entity which has taken legal and legitimate responsibilities for equipment when the original equipment manufacturer no longer exists or supports the equipment.
- .4 *Off-load release mechanism* means a release mechanism which releases the survival craft/rescue boat/fast rescue boat when it is waterborne or when there is no load on the hooks.
- .5 *On-load release mechanism* means a release mechanism which releases the survival craft/rescue boat/fast rescue boat with load on the hooks.
- .6 *Repair* means any activities requiring disassembly of equipment, or any other activities outside the scope of the instructions for on-board maintenance and for emergency repair of life-saving appliances prepared in accordance with SOLAS regulations III/36.2 and III/35.3.18, respectively.
- .7 *Overhaul* means a periodical activity defined by the manufacturer that proves continued fitness for purpose for a defined period subject to correct maintenance.

3 AUTHORIZATION

3.1 Administrations shall ensure that the thorough examination, operational testing, repair and overhaul of equipment (see paragraphs 4.2 and 4.3) shall be carried out in accordance with SOLAS regulation III/20 by service providers authorized in accordance with section 7.

3.2 The requirements in section 7 shall equally apply to manufacturers when they are acting as authorized service providers.

4 QUALIFICATION LEVELS AND CERTIFICATION

4.1 Weekly and monthly inspections and routine maintenance as specified in the equipment maintenance manual(s), shall be conducted by authorized service providers, or by shipboard personnel under the direction of a senior ship's officer in accordance with the maintenance manual(s).

4.2 Annual thorough examinations and operational tests, as described in section 6.2, shall be conducted by certified personnel of either the manufacturer or an authorized service provider in accordance with section 7 and section 8. The service provider may be the ship operator provided that it is authorized in accordance with section 3 and section 7.

4.3 Five-year thorough examination, any overhaul, overload operational tests², as described in section 6.3, and repair shall be conducted by certified personnel of either the manufacturer or an authorized service provider in accordance with section 7 and section 8.

² See SOLAS regulations III/20.11.1.2, III/20.11.2.2 and III/20.11.3.2.

5 REPORTS AND RECORDS

5.1 All reports and checklists shall be completed and signed by the person who carries out the inspection and maintenance work and countersigned by the Company's representative or the ship's master.

5.2 Records of maintenance, thorough examination, operational testing, overhaul and repair shall be updated and filed on board the ship for the service life of the equipment.

5.3 When thorough examination, operational testing, overhaul and repair are completed, a statement confirming that the lifeboat arrangements remain fit for purpose shall be promptly issued by the manufacturer or authorized service provider that conducted the work. A copy of valid documents of certification and authorization as appropriate shall be included with the statement.

6 SPECIFIC PROCEDURES FOR INSPECTION, MAINTENANCE, THOROUGH EXAMINATION, OPERATIONAL TESTING, OVERHAUL AND REPAIR

6.1 General/Maintenance

6.1.1 Any inspection, maintenance, thorough examination, operational testing, overhaul and repair shall be carried out according to the maintenance manuals and associated technical documentation developed by the manufacturer.

6.1.2 A full set of maintenance manuals and associated technical documentation as specified in paragraph 6.1.1 shall be available on board.

6.1.3 The maintenance manuals and associated technical documentation as specified in paragraph 6.1.1 shall include the items listed in sections 6.2 and 6.3 as a minimum and shall be kept up to date by the Company taking into account relevant information provided by the manufacturer.

6.2 Annual thorough examination and operational test

6.2.1 All items listed in checklists for the weekly/monthly inspections required by SOLAS regulations III/20.6 and III/20.7 also form the first part of the annual thorough examination.

6.2.2 Records of inspections and routine on-board maintenance carried out by the ship's crew and the applicable certificates for the equipment shall be reviewed.

6.2.3 For lifeboats (including free-fall lifeboats), rescue boats and fast rescue boats, the following items shall be thoroughly examined and checked for satisfactory condition and operation:

- .1 condition of the boat structure including fixed and loose equipment (including a visual examination of the external boundaries of the void spaces, as far as practicable);
- .2 engine and propulsion system;
- .3 sprinkler system, where fitted;
- .4 air supply system, where fitted;

- .5 manoeuvring system;
- .6 power supply system;
- .7 bailing system;
- .8 fender/skate arrangements; and
- .9 rescue boat righting system, where fitted.

6.2.4 For release gear of lifeboats (including free-fall lifeboats), rescue boats, fast rescue boats and liferafts, the following shall be thoroughly examined for satisfactory condition³ and operation after the annual operational test of the winch brake with the empty boat or equivalent load, as required by paragraph 6.2.10:

- .1 operation of devices for activation of release gear;
- .2 excessive free play (tolerances);
- .3 hydrostatic interlock system, where fitted;
- .4 cables for control and release; and
- .5 hook fastening.

Notes: 1 The setting and maintenance of release gear are critical operations with regard to maintaining the safe operation of lifeboats (including free-fall lifeboats), rescue boats, fast rescue boats and davit launched liferafts. Utmost care shall be taken when carrying out all inspection and maintenance operations on the equipment.

2 No maintenance or adjustment of the release gear shall be undertaken while the hooks are under load.

6.2.5 The operational test of davit-launched lifeboats' and rescue boats' on-load release function shall be carried out as follows:

- .1 position the boat partially in the water such that the mass of the boat is substantially supported by the falls and the hydrostatic interlock system, where fitted, is not triggered;
- .2 operate the on-load release gear;
- .3 reset the on-load release gear; and
- .4 examine the release gear and hook fastening to ensure that the hook is completely reset and no damage has occurred.

³ Hanging-off pennants may be used for this purpose but should not remain connected at other times, such as when the lifeboat is normally stowed and during training exercises. The release gear is to be examined prior to its operational test. The release gear is to be re-examined after its operational test and the operational test of the winch brake. Special consideration shall be given to ensure that no damage has occurred during the winch brake test, especially to the hook fastening.

6.2.6 The operational test of davit-launched lifeboats' and rescue boats' off-load release function shall be carried out as follows:

- .1 position the boat so that it is fully waterborne;
- .2 operate the off-load release gear;
- .3 reset the off-load release gear; and
- .4 recover the boat to the stowed position and prepare for operational readiness.

During the test, prior to hoisting, it shall be checked that the release gear is completely and properly reset. The final turning-in of the boat shall be done without any persons on board.

6.2.7 The operational test of the free-fall lifeboat release function shall be carried out as follows:

- .1 engage the arrangements for the test without launching the lifeboat, required by paragraph 4.7.6.4 of the LSA Code, as specified in the manufacturer's operating instructions;
- .2 if required to be on board, ensure that the operator is properly seated and secured in the seat location from which the release mechanism is to be operated;
- .3 operate the release mechanism to release the lifeboat;
- .4 reset the lifeboat in the stowed configuration;
- .5 repeat the procedures referred to in .2 to .4 above, using the back-up release mechanism, if applicable;
- .6 remove the arrangements for the test without launching the lifeboat, required by paragraph 4.7.6.4 of the LSA Code; and
- .7 verify that the lifeboat is in the ready to launch stowed configuration.

6.2.8 The operational test of the davit-launched liferaft automatic release function shall be carried out as follows:

- .1 manually release the hook with a load of 150 kg on the hook;
- .2 automatically release the hook with a dummy weight of 200 kg on the hook when it is lowered to the ground; and
- .3 examine the release hook and hook fastening to ensure that the hook is completely reset and no damage has occurred.

If a raft is used for the test instead of a dummy weight, the automatic release function shall release the raft when waterborne.

6.2.9 For launching appliances for lifeboats (including free-fall lifeboats), rescue boats, fast rescue boats and liferafts, the following items shall be examined for satisfactory condition and operation:

- .1 davit or other launching structures, in particular with regard to corrosion, misalignments, deformation and excessive free play;
- .2 wires and sheaves, possible damage such as kinks and corrosion;
- .3 lubrication of wires, sheaves and moving parts; and
- .4 if applicable:
 - .1 functioning of limit switches;
 - .2 stored power systems;
 - .3 hydraulic systems; and
- .5 for winches:
 - .1 inspecting the braking system in accordance with winch manual;
 - .2 replacing brake pads, when necessary;
 - .3 winch foundation; and
 - .4 if applicable:
 - .1 remote control system; and
 - .2 power supply system.

6.2.10 For winches of the launching appliances for lifeboats (including free-fall lifeboats), rescue boats, fast rescue boats and liferafts, annual operational testing shall be done by lowering the empty craft or boat or equivalent load. When the craft has reached its maximum lowering speed and before the craft enters the water, the brake shall be abruptly applied. Following these tests, the stressed structural parts shall be reinspected⁴ where the structure permits the reinspection.

6.3 Five-year thorough examination, overhaul and overload operational tests

6.3.1 The five-year operational test of the winches of the launching appliances shall be carried out with a proof load equal to 1.1 times the weight of the survival craft or rescue boat and its full complement of persons and equipment. When the proof load has reached its maximum lowering speed, the brake shall be abruptly applied.

6.3.2 Following these tests, the stressed structural parts shall be reinspected⁴ where the structure permits the reinspection.

⁴ In loading the craft or boat for this test, precautions should be taken to ensure that the stability of the craft or boat is not adversely affected by free surface effects or the raising of the centre of gravity.

6.3.3 The operational tests and overhaul at five-year intervals of release gear for lifeboats (including free-fall lifeboats), rescue boats, fast rescue boats and liferafts shall include:

- .1 dismantling of hook release units;
- .2 examinations with regard to tolerances and design requirements;
- .3 adjustment of release gear system after assembly;
- .4 operational tests as per paragraphs 6.2.5, 6.2.6, 6.2.7 or 6.2.8 above, as applicable, but with a load equal to 1.1 times the weight of the survival craft or rescue boat and its full complement of persons and equipment; and
- .5 examinations of vital parts with regard to defects and cracks⁵.

6.3.4 Any other overhaul if required shall be carried out in accordance with paragraph 6.3.3.

7 REQUIREMENTS FOR AUTHORIZATION OF SERVICE PROVIDERS

7.1 Authorization as required by paragraph 3.1 shall include, as a minimum, demonstration of:

- .1 employment and documentation of personnel certified in accordance with a recognized national, international or industry standard as applicable, or a manufacturer's established certification programme. In either case, the certification programme shall comply with section 8 for each make and type of equipment for which service is to be provided;
- .2 availability of sufficient tools, and in particular any specialized tools specified in the manufacturer's instructions, including portable tools as needed for work to be carried out on board ship;
- .3 access to appropriate parts and accessories as specified for maintenance and repair;
- .4 availability of the manufacturer's instructions for repair work involving disassembly or adjustment of on-load release mechanisms and davit winches; and
- .5 a documented and certified quality system, which covers at least the following:
 - .1 code of conduct for personnel involved in the relevant activity;
 - .2 maintenance and calibration of measuring tools and gauges;
 - .3 training programmes for personnel;
 - .4 supervision and verification to ensure compliance with operational procedures;
 - .5 recording and reporting of information;

⁵ Non-destructive examination (NDE) techniques, such as dye penetrants (DPE), may be suitable.

- .6 quality management of subsidiaries and agents;
- .7 job preparation; and
- .8 periodic review of work process procedures, complaints, corrective actions and issuance, maintenance and control of documents.

Note: A documented quality system complying with the most current version of the ISO 9000 series and including the above items would be considered acceptable.

7.2 Administrations shall ensure that information regarding authorized service providers is made available.

7.3 In cases where a manufacturer is no longer in business or no longer provides technical support, Administrations may authorize service providers for the equipment on the basis of prior authorization for the equipment and/or long-term experience and demonstrated expertise as an authorized service provider.

7.4 Issuance and maintenance of authorization document:

- .1 upon successful initial audit of a service provider, an authorization document shall be issued by the Administration defining the scope of services provided (e.g. makes and types of equipment). The expiry date shall be clearly written on the document;
- .2 the Administration shall ensure that work continues, e.g. by periodic audit, to be carried out in accordance with these Requirements, and shall withdraw the authorization of service providers who are not in compliance; and
- .3 the Administration may accept or recognize service providers authorized by other Administrations or by their Recognized Organizations.

8 REQUIREMENTS FOR CERTIFICATION OF PERSONNEL

8.1 Personnel for the work specified in paragraphs 4.2 and 4.3 shall be certified by the manufacturer or authorized service provider for each make and type of the equipment to be worked on in accordance with the provisions in this section.

8.2 Education and training

8.2.1 Initial certification shall be issued only to personnel having completed education, training and competence assessment. Education shall address, as a minimum:

- .1 relevant rules and regulations, including international conventions;
- .2 design and construction of lifeboats (including free-fall lifeboats), rescue boats and fast rescue boats, including on-load release gear and launching appliances;
- .3 causes of lifeboat and rescue boat accidents;
- .4 education and practical training in the procedures specified in section 6 for which certification is sought;

- .5 detailed procedures for thorough examination, operational testing, repair and overhaul of lifeboat (including free-fall lifeboats), rescue boats and fast rescue boats, launching appliances and on-load release gear, as applicable;
- .6 procedures for issuing a report of service and statement of fitness for purpose based on paragraph 5.3; and
- .7 work, health and safety issues while conducting activities on board.

8.2.2 Training shall include practical technical training on thorough examination, operational testing, maintenance, repair and overhaul techniques using the equipment for which the personnel are to be certified. The technical training shall include disassembly, reassembly, correct operation and adjustment of the equipment. Classroom training shall be supplemented by field experience in the operations for which certification is sought, under the supervision of a certified person.

8.2.3 Prior to issuance of certification, a competency assessment shall be satisfactorily completed, using the equipment for which the personnel are to be certified.

8.3 Validity of certificates and renewal

8.3.1 Upon completion of training and competency assessment, a certificate shall be issued defining the level of qualification and the scope of the certification (i.e. makes and types of equipment and specifically state which activities in paragraphs 4.2 and 4.3 are covered by the certification). The expiry date shall clearly be written on the certificate and shall be three years from the date of issue. The validity of any certificate shall be suspended in the event of any shortfall in performance and only revalidated after a further competency assessment.

8.3.2 A competency assessment shall be conducted to renew the certification. In cases where refresher training is found necessary a further assessment shall be carried out after completion.

ANNEX 2

**RESOLUTION MSC.403(96)
(adopted on 19 May 2016)**

**AMENDMENTS TO THE INTERNATIONAL CODE
FOR FIRE SAFETY SYSTEMS (FSS CODE)**

THE MARITIME SAFETY COMMITTEE,

RECALLING Article 28(b) of the Convention on the International Maritime Organization concerning the functions of the Committee,

NOTING resolution MSC.98(73), by which it adopted the International Code for Fire Safety Systems ("the FSS Code"), which has become mandatory under chapter II-2 of the International Convention for the Safety of Life at Sea, 1974 ("the Convention"),

NOTING ALSO article VIII(b) and regulation II-2/3.22 of the Convention concerning the procedure for amending the FSS Code,

HAVING CONSIDERED, at its ninety-sixth session, amendments to the FSS Code proposed and circulated in accordance with article VIII(b)(i) of the Convention,

1 ADOPTS, in accordance with article VIII(b)(iv) of the Convention, amendments to the FSS Code the text of which is set out in the annex to the present resolution;

2 DETERMINES, in accordance with article VIII(b)(vi)(2)(bb) of the Convention, that the said amendments shall be deemed to have been accepted on 1 July 2019 unless, prior to that date, more than one third of the Contracting Governments to the Convention, or Contracting Governments the combined merchant fleets of which constitute not less than 50% of the gross tonnage of the world's merchant fleet, have notified the Secretary-General of their objections to the amendments;

3 INVITES Contracting Governments to the Convention to note that, in accordance with article VIII(b)(vii)(2) of the Convention, the amendments shall enter into force on 1 January 2020 upon their acceptance in accordance with paragraph 2 above;

4 REQUESTS the Secretary-General, for the purposes of article VIII(b)(v) of the Convention, to transmit certified copies of the present resolution and the text of the amendments contained in the annex to all Contracting Governments to the Convention;

5 REQUESTS ALSO the Secretary-General to transmit copies of this resolution and its annex to Members of the Organization, which are not Contracting Governments to the Convention.

ANNEX

**AMENDMENTS TO THE INTERNATIONAL CODE
FOR FIRE SAFETY SYSTEMS (FSS CODE)**

**CHAPTER 8
AUTOMATIC SPRINKLER, FIRE DETECTION AND FIRE ALARM SYSTEMS**

- 1 The text in existing paragraph 2.4.1 is replaced with the following:

"2.4.1 General

2.4.1.1 Any parts of the system which may be subjected to freezing temperatures in service shall be suitably protected against freezing.

2.4.1.2 Special attention shall be paid to the specification of water quality provided by the system manufacturer to prevent internal corrosion of sprinklers and clogging or blockage arising from products of corrosion or scale-forming minerals."

- 2 A new chapter 17 is added after existing chapter 16 as follows:

**"CHAPTER 17
HELICOPTER FACILITY FOAM FIREFIGHTING APPLIANCES**

1 Application

This chapter details the specifications for foam firefighting appliances for the protection of helidecks and helicopter landing areas as required by chapter II-2 of the Convention.

2 Definitions

2.1 *D-value* means the largest dimension of the helicopter used for assessment of the helideck when its rotors are turning. It establishes the required area of foam application.

2.2 *Deck integrated foam nozzles* are foam nozzles recessed into or edge mounted on the helideck.

2.3 *Foam-making branch pipes* are air-aspirating nozzles in tube shape for producing and discharging foam, usually in straight stream only.

2.4 *Helicopter landing area* is as defined in SOLAS regulation II-2/3.57.

2.5 *Helideck* is as defined in SOLAS II-2/3.26.

2.6 *Hose reel foam station* is a hose reel fitted with a foam-making branch pipe and non-collapsible hose, together with fixed foam proportioner and fixed foam concentrate tank, mounted on a common frame.

2.7 *Monitor foam station* is a foam monitor, either self-inducing or together with separate fixed foam proportioner, and fixed foam concentrate tank, mounted on a common frame.

2.8 *Obstacle free sector* is the take-off and approach sector which totally encompasses the safe landing area and extends over a sector of at least 210°, within which only specified obstacles are permitted.

2.9 *Limited obstacle sector* is a 150° sector outside the take-off and approach sector that extends outward from a helideck where objects of limited height are permitted.

3 Engineering specifications for helidecks and helicopter landing areas

3.1 The system shall be capable of manual release, and may be arranged for automatic release.

3.2 For helidecks the foam system shall contain at least two fixed foam monitors or deck integrated foam nozzles. In addition, at least two hose reels fitted with a foam-making branch pipe and non-collapsible hose sufficient to reach any part of the helideck shall be provided. The minimum foam system discharge rate shall be determined by multiplying the D-value area by 6 l/min/m². The minimum foam system discharge rate for deck integrated foam nozzle systems shall be determined by multiplying the overall helideck area by 6 l/min/m². Each monitor shall be capable of supplying at least 50% of the minimum foam system discharge rate, but not less than 500 l/min. The minimum discharge rate of each hose reel shall be at least 400 l/min. The quantity of foam concentrate shall be adequate to allow operation of all connected discharge devices for at least 5 min.

3.3 Where foam monitors are installed, the distance from the monitor to the farthest extremity of the protected area shall be not more than 75% of the monitor throw in still air conditions.

3.4 For helicopter landing areas, at least two portable foam applicators or two hose reel foam stations shall be provided, each capable of discharging a minimum foam solution discharge rate, in accordance with the following table.

Category	Helicopter overall length (D-value)	Minimum foam solution discharge rate (l/min)
H1	up to but not including 15 m	250
H2	from 15 m up to but not including 24 m	500
H3	from 24 m up to but not including 35 m	800

The quantity of foam concentrate shall be adequate to allow operation of all connected discharge devices for at least 10 min. For tankers fitted with a deck foam system, the Administration may consider an alternative arrangement, taking into account the type of foam concentrate to be used.

3.5 Manual release stations capable of starting necessary pumps and opening required valves, including the fire main system, if used for water supply, shall be located at each monitor and hose reel. In addition, a central manual release station shall be provided at a protected location. The foam system shall be designed to discharge foam with nominal flow and at design pressure from any connected discharge devices within 30 s of activation.

3.6 Activation of any manual release station shall initiate the flow of foam solution to all connected hose reels, monitors, and deck integrated foam nozzles.

3.7 The system and its components shall be designed to withstand ambient temperature changes, vibration, humidity, shock impact and corrosion normally encountered on the open deck, and shall be manufactured and tested to the satisfaction of the Administration.

3.8 A minimum nozzle throw of at least 15 m shall be provided with all hose reels and monitors discharging foam simultaneously. The discharge pressure, flow rate and discharge pattern of deck integrated foam nozzles shall be to the satisfaction of the Administration, based on tests that demonstrate the nozzle's capability to extinguish fires involving the largest size helicopter for which the helideck is designed.

3.9 Monitors, foam-making branch pipes, deck integrated foam nozzles and couplings shall be constructed of brass, bronze or stainless steel. Piping, fittings and related components, except gaskets, shall be designed to withstand exposure to temperatures up to 925°C.

3.10 The foam concentrate shall be demonstrated effective for extinguishing aviation fuel spill fires and shall conform to performance standards not inferior to those acceptable to the Organization.* Where the foam storage tank is on the exposed deck, freeze protected foam concentrates shall be used, if appropriate, for the area of operation.

3.11 Any foam system equipment installed within the take-off and approach obstacle-free sector shall not exceed a height of 0.25 m. Any foam system equipment installed in the limited obstacle sector shall not exceed the height permitted for objects in this area.

3.12 All manual release stations, monitor foam stations, hose reel foam stations, hose reels and monitors shall be provided with a means of access that does not require travel across the helideck or helicopter landing area.

3.13 Oscillating monitors, if used, shall be pre-set to discharge foam in a spray pattern and have a means of disengaging the oscillating mechanism to allow rapid conversion to manual operation.

3.14 If a foam monitor with flow rate up to 1,000 l/min is installed, it shall be equipped with an air-aspirating nozzle. If a deck integrated nozzle system is installed, then the additionally installed hose reel shall be equipped with an air-aspirating handline nozzle (foam branch pipes). Use of non-air-aspirating foam nozzles (on both monitors and the additional hose reel) is permitted only where foam monitors with a flow rate above 1,000 l/min are installed. If only portable foam applicators or hose reel stations are provided, these shall be equipped with an air-aspirating handline nozzle (foam branch pipes).

* Refer to the International Civil Aviation Organization Airport Services Manual, part 1, Rescue and Fire Fighting, chapter 8, Extinguishing Agent Characteristics, paragraph 8.1.5, Foam specifications table 8-1, Performance Level B, or to the *Revised Guidelines for the performance and testing criteria, and surveys of foam concentrates for fixed fire-extinguishing systems* (MSC.1/Circ.1312)."

ANNEX 3

**RESOLUTION MSC.404(96)
(adopted on 19 May 2016)**

**AMENDMENTS TO THE INTERNATIONAL CONVENTION
FOR THE SAFETY OF LIFE AT SEA, 1974, AS AMENDED**

THE MARITIME SAFETY COMMITTEE,

RECALLING Article 28(b) of the Convention on the International Maritime Organization concerning the functions of the Committee,

RECALLING ALSO article VIII(b) of the International Convention for the Safety of Life at Sea, 1974 ("the Convention"), concerning the amendment procedure applicable to the annex to the Convention, other than to the provisions of chapter I,

HAVING CONSIDERED, at its ninety-sixth session, amendments to the Convention proposed and circulated in accordance with article VIII(b)(i) of the Convention,

1 ADOPTS, in accordance with article VIII(b)(iv) of the Convention, amendments to the Convention the text of which is set out in the annex to the present resolution;

2 DETERMINES, in accordance with article VIII(b)(vi)(2)(bb) of the Convention, that the said amendments shall be deemed to have been accepted on 1 July 2019, unless, prior to that date, more than one third of the Contracting Governments to the Convention, or Contracting Governments the combined merchant fleets of which constitute not less than 50% of the gross tonnage of the world's merchant fleet, have notified the Secretary-General of their objections to the amendments;

3 INVITES Contracting Governments to the Convention to note that, in accordance with article VIII(b)(vii)(2) of the Convention, the amendments shall enter into force on 1 January 2020 upon their acceptance in accordance with paragraph 2 above;

4 REQUESTS the Secretary-General, for the purposes of article VIII(b)(v) of the Convention, to transmit certified copies of the present resolution and the text of the amendments contained in the annex to all Contracting Governments to the Convention;

5 REQUESTS ALSO the Secretary-General to transmit copies of this resolution and its annex to Members of the Organization, which are not Contracting Governments to the Convention.

ANNEX

**AMENDMENTS TO THE INTERNATIONAL CONVENTION FOR
THE SAFETY OF LIFE AT SEA, 1974, AS AMENDED**

**CHAPTER II-2
CONSTRUCTION – FIRE PROTECTION, FIRE DETECTION
AND FIRE EXTINCTION**

**PART A
GENERAL**

Regulation 3 – Definitions

1 The following new paragraphs are added after the existing paragraph 56:

"57 *Helicopter landing area* is an area on a ship designated for occasional or emergency landing of helicopters but not designed for routine helicopter operations.

58 *Winching area* is a pick-up area provided for the transfer by helicopter of personnel or stores to or from the ship, while the helicopter hovers above the deck.

**PART D
ESCAPE**

Regulation 13 – Means of escape

1 The footnote to the title of paragraph 3.2 is deleted.

2 The following new paragraphs are added after the existing paragraph 3.2.6.2:

"3.2.7 *Evacuation analysis for passenger ships**

3.2.7.1 Escape routes shall be evaluated by an evacuation analysis early in the design process. This analysis shall apply to:

- .1 ro-ro passenger ships constructed on or after 1 July 1999; and
- .2 other passenger ships constructed on or after 1 January 2020 carrying more than 36 passengers.

3.2.7.2 The analysis shall be used to identify and eliminate, as far as practicable, congestion which may develop during an abandonment, due to normal movement of passengers and crew along escape routes, including the possibility that crew may need to move along these routes in a direction opposite to the movement of passengers. In addition, the analysis shall be used to demonstrate that escape arrangements are sufficiently flexible to provide for the possibility that certain escape routes, assembly stations, embarkation stations or survival craft may not be available as a result of a casualty.

* Refer to the *Revised Guidelines on evacuation analyses for new and existing passenger ships* (MSC.1/Circ.1533), as may be amended."

3 Paragraph 7.4 is deleted.

PART G
SPECIAL REQUIREMENTS

Regulation 18 – Helicopter facilities

4 A new paragraph 2.3 is added after the existing paragraph 2.2, as follows:

"2.3 Notwithstanding the requirements of paragraph 2.2 above, ships constructed on or after 1 January 2020, having a helicopter landing area, shall be provided with foam firefighting appliances which comply with the relevant provisions of chapter 17 of the Fire Safety Systems Code."

and the subsequent paragraphs are renumbered accordingly.

5 The renumbered paragraph 2.4 is replaced with the following text:

"2.4 Notwithstanding the requirements of paragraph 2.2 or 2.3 above, ro-ro passenger ships without helidecks shall comply with regulation III/28."

6 A new paragraph 5.1.6 is added after the existing paragraph 5.1.5 as follows:

".6 in lieu of the requirements of paragraphs 5.1.3 through 5.1.5, on ships constructed on or after 1 January 2020 having a helideck, foam firefighting appliances which comply with the provisions of the Fire Safety Systems Code."

and the remaining paragraphs are renumbered accordingly.

CHAPTER III
LIFE-SAVING APPLIANCES AND ARRANGEMENTS

PART A
GENERAL

Regulation 3 – Definitions

7 The following new paragraph 25 is added after the existing paragraph 24:

"25 *Requirements for maintenance, thorough examination, operational testing, overhaul and repair* means the Requirements for maintenance, thorough examination, operational testing, overhaul and repair of lifeboats and rescue boats, launching appliances and release gear, adopted by the Maritime Safety Committee of the Organization by resolution MSC.402(96), as may be amended by the Organization, provided that such amendments are adopted, brought into force and take effect in accordance with the provisions of article VIII of the present Convention concerning the amendment procedures applicable to the annex other than chapter I."

PART B
REQUIREMENTS FOR SHIPS AND LIFE-SAVING APPLIANCES

Regulation 20 – Operational readiness, maintenance and inspections

- 8 The existing paragraph 3.1 is replaced with the following text:
- "3.1 Maintenance, testing and inspections of life-saving appliances shall be carried out in a manner having due regard to ensuring reliability of such appliances."
- 9 The existing paragraph 11 is replaced with the following text:
- "11 Maintenance, thorough examination, operational testing, overhaul and repair of lifeboats, rescue boats and fast rescue boats, launching appliances and release gear**
- 11.1 Launching appliances shall be:
- .1 subject to a thorough examination at the annual surveys required by regulations I/7 or I/8, as applicable; and
 - .2 upon completion of the examination referred to in paragraph 11.1.1, subjected to a dynamic test of the winch brake at maximum lowering speed. The load to be applied shall be the mass of the survival craft or rescue boat without persons on board, except that, at intervals of at least once every five years, the test shall be carried out with a proof load equal to 1.1 times the weight of the survival craft or rescue boat and its full complement of persons and equipment.
- 11.2 Lifeboat and rescue boat release gear, including fast rescue boat release gear and free-fall lifeboat release systems, shall be:
- .1 subject to a thorough examination and operational test during the annual surveys required by regulations I/7 and I/8;
 - .2 in case of on-load release gear, operationally tested under a load of 1.1 times the total mass of the boat when loaded with its full complement of persons and equipment whenever the release gear is overhauled. Such overhauling and operational test shall be carried out at least once every five years;^{*} and
 - .3 notwithstanding paragraph 11.2.2, the operational testing of free-fall lifeboat release systems shall be performed either by free fall launch with only the operating crew on board or by a test without launching the lifeboat carried out based on Requirements for maintenance, thorough examination, operational testing, overhaul and repair.

^{*} Refer to *Recommendation on testing of life-saving appliances* (resolution A.689(17)), as amended. For life-saving appliances installed on board on or after 1 July 1999, refer to *Revised Recommendations on testing of life-saving appliances* (resolution MSC.81(70)), as amended.

- 11.3 Davit-launched liferaft automatic release hooks shall be:
- .1 subject to a thorough examination and operational test during the annual surveys required by regulations I/7 and I/8; and
 - .2 operationally tested under a load of 1.1 times the total mass of the liferaft when loaded with its full complement of persons and equipment whenever the automatic release hook is overhauled. Such overhauling and operational test shall be carried out at least once every five years.*
- 11.4 Lifeboats and rescue boats, including fast rescue boats, shall be subject to a thorough examination and operational test during the annual surveys required by regulations I/7 and I/8.
- 11.5 The thorough examination, operational testing and overhaul required by paragraphs 11.1 to 11.4 and the maintenance and repair of equipment specified in paragraphs 11.1 to 11.4 shall be carried out in accordance with the Requirements for maintenance, thorough examination, operational testing, overhaul and repair, and the instructions for onboard maintenance as required by regulation 36.

* Refer to *Recommendation on testing of life-saving appliances* (resolution A.689(17)), as amended. For life-saving appliances installed on board on or after 1 July 1999, refer to *Revised Recommendations on testing of life-saving appliances* (resolution MSC.81(70)), as amended."

ANNEX 4

RESOLUTION MSC.405(96)
(adopted on 19 May 2016)

**AMENDMENTS TO THE INTERNATIONAL CODE ON THE ENHANCED PROGRAMME
OF INSPECTIONS DURING SURVEYS OF BULK CARRIERS AND OIL TANKERS, 2011
(2011 ESP CODE)**

THE MARITIME SAFETY COMMITTEE,

RECALLING Article 28(b) of the Convention on the International Maritime Organization concerning the functions of the Committee,

NOTING resolution A.1049(27), by which the Assembly adopted the International Code on the Enhanced Programme of Inspections during Surveys of Bulk Carriers and Oil Tankers, 2011 ("the 2011 ESP Code"), which has become mandatory under chapter XI-1 of the International Convention for the Safety of Life at Sea, 1974 ("the Convention"),

NOTING ALSO article VIII(b) and regulation XI-1/2 of the Convention concerning the procedure for amending the 2011 ESP Code,

HAVING CONSIDERED, at its ninety-sixth session, amendments to the 2011 ESP Code proposed and circulated in accordance with article VIII(b)(i) of the Convention,

1 ADOPTS, in accordance with article VIII(b)(iv) of the Convention, amendments to the 2011 ESP Code the text of which is set out in the annex to the present resolution;

2 DETERMINES, in accordance with article VIII(b)(vi)(2)(bb) of the Convention, that the said amendments shall be deemed to have been accepted on 1 July 2017 unless, prior to that date, more than one third of the Contracting Governments to the Convention, or Contracting Governments the combined merchant fleets of which constitute not less than 50% of the gross tonnage of the world's merchant fleet, have notified the Secretary-General of their objections to the amendments;

3 INVITES Contracting Governments to the Convention to note that, in accordance with article VIII(b)(vii)(2) of the Convention, the amendments shall enter into force on 1 January 2018 upon their acceptance in accordance with paragraph 2 above;

4 REQUESTS the Secretary-General, for the purposes of article VIII(b)(v) of the Convention, to transmit certified copies of the present resolution and the text of the amendments contained in the annex to all Contracting Governments to the Convention;

5 REQUESTS ALSO the Secretary-General to transmit copies of this resolution and its annex to Members of the Organization, which are not Contracting Governments to the Convention.

ANNEX

**AMENDMENTS TO THE INTERNATIONAL CODE ON THE ENHANCED PROGRAMME
OF INSPECTIONS DURING SURVEYS OF BULK CARRIERS AND OIL TANKERS, 2011
(2011 ESP CODE)**

ANNEX A

**CODE ON THE ENHANCED PROGRAMME OF INSPECTIONS DURING SURVEYS OF
BULK CARRIERS**

Part A

**CODE ON THE ENHANCED PROGRAMME OF INSPECTIONS DURING SURVEYS OF
BULK CARRIERS HAVING SINGLE-SIDE SKIN CONSTRUCTION**

1 In paragraph 4.2.1.3, the words "hard protective" are inserted after the words "When such breakdown of".

2 Paragraph 5.2.2 is replaced with the following text:

"5.2.2 In order to enable the attending surveyors to carry out the survey, provisions for proper and safe access should be agreed between the owner and the Administration, based on recommendations developed by the Organization.³

³ Refer to the *Revised recommendations for entering enclosed spaces aboard ships*, adopted by the Organization by resolution A.1050(27)."

3 Paragraph 5.2.9 is replaced with the following text:

"5.2.9 The surveyor(s) should always be accompanied by at least one responsible person, assigned by the owner, experienced in tank and enclosed space inspection."

4 Paragraph 5.2.10 is deleted.

Part B

CODE ON THE ENHANCED PROGRAMME OF INSPECTIONS DURING SURVEYS OF BULK CARRIERS HAVING DOUBLE-SIDE SKIN CONSTRUCTION

5 Paragraph 5.2.2 is replaced with the following text:

"5.2.2 In order to enable the attending surveyors to carry out the survey, provisions for proper and safe access should be agreed between the owner and the Administration, based on recommendations developed by the Organization.⁷

⁷ Refer to the *Revised recommendations for entering enclosed spaces aboard ships*, adopted by the Organization by resolution A.1050(27)."

6 Paragraph 5.2.9 is replaced with the following text:

"5.2.9 The surveyor(s) should always be accompanied by, at least, one responsible person, assigned by the owner, experienced in tank and enclosed space inspection."

7 Paragraph 5.2.10 is deleted.

ANNEX B

CODE ON THE ENHANCED PROGRAMME OF INSPECTIONS DURING SURVEYS OF OIL TANKERS

Part A

CODE ON THE ENHANCED PROGRAMME OF INSPECTIONS DURING SURVEYS OF DOUBLE-HULL OIL TANKERS

8 Paragraph 5.2.1.1 is replaced with the following text:

"5.2.1.1 In order to enable the attending surveyors to carry out the survey, provisions for proper and safe access should be agreed between the owner and the Administration, based on recommendations developed by the Organization.¹¹

¹¹ Refer to the *Revised recommendations for entering enclosed spaces aboard ships*, adopted by the Organization by resolution A.1050(27)."

- 9 Paragraph 5.2.6 is replaced with the following text:
- "5.2.6 The surveyor(s) should always be accompanied by at least one responsible person, assigned by the owner, experienced in tank and enclosed space inspection."
- 10 Paragraph 5.2.7 is deleted.

Part B

CODE ON THE ENHANCED PROGRAMME OF INSPECTIONS DURING SURVEYS OF OIL TANKERS OTHER THAN DOUBLE-HULL OIL TANKERS

- 11 Paragraph 5.2.1.1 is replaced with the following text:
- "5.2.1.1 In order to enable the attending surveyors to carry out the survey, provisions for proper and safe access should be agreed between the owner and the Administration, based on recommendations developed by the Organization.¹⁵
-
- ¹⁵ Refer to the *Revised recommendations for entering enclosed spaces aboard ships*, adopted by the Organization by resolution A.1050(27)."
- 12 Paragraph 5.2.6 is replaced with the following text:
- "5.2.6 The surveyor(s) should always be accompanied by at least one responsible person, assigned by the owner, experienced in tank and enclosed space inspection."
- 13 Paragraph 5.2.7 is deleted.

ANNEX 11

**RESOLUTION MSC.407(96)
(adopted on 19 May 2016)**

**AMENDMENTS TO THE CODE FOR THE CONSTRUCTION AND EQUIPMENT
OF MOBILE OFFSHORE DRILLING UNITS, 2009 (2009 MODU CODE)**

THE MARITIME SAFETY COMMITTEE,

RECALLING Article 28(b) of the Convention on the International Maritime Organization concerning the functions of the Committee,

RECALLING ALSO that the Assembly, when adopting resolution A.1023(26) on the Code for the Construction and Equipment of Mobile Offshore Drilling Units, 2009 (2009 MODU Code), authorized the Committee to amend the Code as appropriate, taking into consideration development in the design and technologies, in consultation with appropriate organizations,

RECOGNIZING the need for harmonizing the requirements for helicopter facility foam firefighting appliances,

HAVING CONSIDERED, at its ninety-sixth session, the recommendations made by the Sub-Committee on Ship Systems and Equipment, at its second session,

1 ADOPTS amendments to the 2009 MODU Code, set out in the annex to the present resolution;

2 INVITES all Governments concerned to take appropriate steps to give effect to the annexed amendments to the 2009 MODU Code by 1 January 2020.

ANNEX

**AMENDMENTS TO THE CODE FOR THE CONSTRUCTION AND EQUIPMENT
OF MOBILE OFFSHORE DRILLING UNITS, 2009 (2009 MODU CODE)**

**CHAPTER 9
FIRE SAFETY**

Paragraph 9.16 – Provisions for helicopter facilities

The following new paragraph 9.16.4.6 is added after existing paragraph 9.16.4.5, and the remaining paragraphs renumbered accordingly:

".6 in lieu of the provisions of paragraphs 9.16.4.3 to 9.16.4.5, on units constructed on or after 1 January 2020, foam firefighting appliances complying with the provisions of the FSS Code;"

ANNEX 13

DRAFT AMENDMENTS TO SOLAS REGULATIONS II-2/1 AND II-2/10¹

CHAPTER II-2

CONSTRUCTION – FIRE PROTECTION, FIRE DETECTION AND FIRE EXTINCTION

PART A

GENERAL

Regulation 1 – Application

- 1 The following new paragraph is added after existing paragraph 2.8:

"2.9 Regulation 10.5.1.2.2, as amended by resolution MSC...., applies to ships constructed before [*date of entry into force*], including those constructed before 1 July 2012."

PART C

SUPPRESSION OF FIRE

Regulation 10 – Firefighting

- 2 In paragraph 5.1.2.2, the last sentence is amended to read as follows:

"In the case of domestic boilers of less than 175 kW, or boilers protected by fixed water-based local application fire-extinguishing systems as required by paragraph 5.6, an approved foam-type extinguisher of at least 135 l capacity is not required."

¹ Tracked changes are created using "strikeout" for deleted text and "grey shading" to highlight all modifications and new insertions, including deleted text.

ANNEX 14

DRAFT NEW SOLAS REGULATION XI-1/2-1

**CHAPTER XI-1
SPECIAL MEASURES TO ENHANCE MARITIME SAFETY**

- 1 The following new regulation 2-1 is inserted after the existing regulation 2:

"Regulation 2-1 – Harmonization of survey periods of cargo ships not subject to the ESP Code

For cargo ships not subject to enhanced surveys under regulation XI-1/2, notwithstanding any other provisions, the intermediate and renewal surveys included in regulation I/10 may be carried out and completed over the corresponding periods as specified in the 2011 ESP Code, as may be amended and the guidelines developed by the Organization*, as appropriate.

* Refer to Survey Guidelines under the harmonized system of survey and certification (HSSC), [...], as adopted by the Assembly of the Organization by resolution [A...(....)]."

ANNEX 15

DRAFT AMENDMENTS TO THE IGC CODE

**CHAPTER 3
SHIP ARRANGMENTS**

3.2 Accommodation, service and machinery spaces and control stations

In paragraph 3.2.5, the words "Wheelhouse windows shall be constructed to not less than "A-0" class (for external fire load)." are deleted.

ANNEX 16

DRAFT AMENDMENTS TO SOLAS CHAPTER II-1¹

PART A GENERAL

Regulation 1 – Application

1 The following new paragraphs 1.1.1 and 1.1.2 are added after the existing paragraph 1.1:

"1.1.1 Unless expressly provided otherwise, parts B, B-1, B-2 and B-4 of this chapter shall only apply to ships:

- .1 for which the building contract is placed on or after [date 1]; or
- .2 in the absence of a building contract, the keel of which is laid or which are at a similar stage of construction on or after [date 2]; or
- .3 the delivery of which is on or after [date 3].

1.1.2 Unless expressly provided otherwise, for ships not subject to the provisions of subparagraph 1.1.1 but constructed on or after 1 January 2009, the Administration shall ensure that the requirements for parts B, B-1, B-2 and B-4 which are applicable under chapter II-1 of the International Convention for the Safety of Life at Sea, 1974, as amended by resolutions MSC.216(82), MSC.269(85) and MSC.325(90) are complied with."

2 The existing paragraph 1.3.4 is deleted.

3 The text of existing paragraph 2 is amended to read as follows:

"Unless expressly provided otherwise, for ships constructed before 1 January 2009, the Administration shall ensure that the requirements which are applicable under chapter II-1 of the International Convention for the Safety of Life at Sea, 1974, as amended by resolutions MSC.1(XLV), MSC.6(48), MSC.11(55), MSC.12(56), MSC.13(57), MSC.19(58), MSC.26(60), MSC.27(61), Resolution 1 of the 1995 SOLAS Conference, MSC.47(66), MSC.57(67), MSC.65(68), MSC.69(69), MSC.99(73), MSC.134(76), MSC.151(78), ~~and MSC.170(79) and MSC.[...](99)~~ are complied with."

Regulation 2 – Definitions

4 The existing text of paragraph 2 is replaced with the following:

"2 *Amidships* is at the middle of the length (*L*)."

¹ Tracked changes are created using "strikeout" for deleted text and "grey shading" to highlight all modifications and new insertions, including deleted text.

5 The existing paragraphs 9, 10, 13 and 19 are amended to read as follows:

"9 *Draught (d)* is the vertical distance from the keel line at:

- .1 mid-length amidships, for ships subject to the provisions of regulation II-1/1.1.1.1; and
- .2 the mid-point of the subdivision length (L_s), for ships not subject to the provisions of regulation II-1/1.1.1.1 but constructed on or after 1 January 2009;

to the waterline in question.

10 *Deepest subdivision draught (ds)* is the ~~waterline which corresponds to the~~ summer load line draught of the ship.

...

13 *Trim* is the difference between the draught forward and the draught aft, where the draughts are measured at the forward and aft:

- .1 terminals perpendiculars respectively, as defined in the International Convention on Load Lines in force, for ships subject to the provisions of regulation II-1/1.1.1.1; and
- .2 terminals respectively, for ships not subject to the provisions of regulation II-1/1.1.1.1 but constructed on or after 1 January 2009;

disregarding any rake of keel.

...

19 *Bulkhead deck* in a passenger ship means the uppermost deck:

- .1 ~~at any point in the subdivision length (L_s) to which the main bulkheads and the ship's shell are carried watertight and the lowermost deck from which passenger and crew evacuation will not be impeded by water in any stage of flooding for damage cases defined in regulation 8 and in part B-2 of this chapter, for ships subject to the provisions of regulation II-1/1.1.1.1; and~~
- .2 at any point in the subdivision length (L_s) to which the main bulkheads and the ship's shell are carried watertight and the lowermost deck from which passenger and crew evacuation will not be impeded by water in any stage of flooding for damage cases defined in regulation 8 and in part B-2 of this chapter, for ships not subject to the provisions of regulation II-1/1.1.1.1 but constructed on or after 1 January 2009.

The bulkhead deck may be a stepped deck. ~~In a cargo ship the freeboard deck may be taken as the bulkhead deck. In a cargo ship not subject to the provisions of regulation II-1/1.1.1.1 but constructed on or after 1 January 2009, the freeboard deck may be taken as the bulkhead deck.~~

6 The existing paragraph 26 is deleted and remaining paragraphs are renumbered respectively.

Regulation 3-12 – Protection against noise

7 The existing paragraph 2.1 is amended to read as follows:

"1 contracted for construction before 1 July 2014 and the keels of which are laid or which are at a similar stage of construction on or after 1 January 2009 ~~but before 1 January 2015~~; or"

PART B SUBDIVISION AND STABILITY

Regulation 4 – General

8 The existing paragraph 1 and the footnote to existing paragraph 1 are deleted.

9 The following new paragraphs 1 and 2 are introduced before the existing paragraph 2:

"1 Unless expressly provided otherwise, the requirements in parts B-1 to B-4 shall apply to passenger ships.

2 For cargo ships, the requirements in parts B-1 to B-4 shall apply as follows:

2.1 In part B-1:

2.1.1 Unless expressly provided otherwise, regulation 5 shall apply to cargo ships and regulation 5-1 shall apply to cargo ships other than tankers, as defined in regulation 1/2(h);

2.1.2 Regulation 6 to regulation 7-3 shall apply to cargo ships having a length (*L*) of 80 m and upwards, but may exclude those ships subject to the following instruments and shown to comply with the subdivision and damage stability requirements of that instrument:

.1 Annex I to MARPOL, except that combination carriers (as defined in SOLAS regulation II-2/3.14) with type B freeboards shall be in compliance with regulation 6 to regulation 7-3*; or

.2 the International Code for the Construction and Equipment of Ships Carrying Dangerous Chemicals in Bulk (IBC Code)*; or

.3 the International Code for the Construction and Equipment of Ships Carrying Liquefied Gases in Bulk (IGC Code)*; or

- .4 the damage stability requirements of regulation 27 of the 1966 Load Lines Convention as applied in compliance with resolutions A.320(IX) and A.514(13), provided that in the case of cargo ships to which regulation 27(9) applies, main transverse watertight bulkheads, to be considered effective, are spaced according to paragraph (12)(f) of resolution A.320(IX), except that ships intended for the carriage of deck cargo shall be in compliance with regulation 6 to regulation 7-3; or
- .5 the damage stability requirements of regulation 27 of the 1988 Load Lines Protocol, except that ships intended for the carriage of deck cargo shall be in compliance with regulation 6 to regulation 7-3; or
- .6 the subdivision and damage stability standards in other instruments** developed by the Organization.

2.2 Unless expressly provided otherwise, the requirements in parts B-2 and B-4 shall apply to cargo ships.

* *Guidelines for verification of damage stability requirements for tankers (MSC.1/Circ.1461).*

** .1 For offshore supply vessels of not more than 100 m in length (*L*), the *Guidelines for the design and construction of offshore supply vessels, 2006* (resolution MSC.235(82), as amended by resolution MSC.335(90)); or

.2 For special purpose ships, the *Code of safety for special purpose ships, 2008* (resolution MSC.266(84))."

10 The existing paragraphs 2 to 4 are renumbered respectively.

PART B-1 STABILITY

11 The existing regulation 5 is amended to read as follows:

"Regulation 5 – Intact stability*

1 Every passenger ship, regardless of size and every cargo ship having a length (*L*) of 24 m and upwards, shall be inclined upon its completion ~~and the elements of its stability determined~~. The light ship displacement and the longitudinal, transverse and vertical position of its centre of gravity shall be determined. In addition to any other applicable requirements of the present regulations, ships having a length of 24 m and upwards ~~constructed on or after 1 July 2010~~ shall as a minimum comply with the requirements of part A of the 2008 IS Code.

2 The Administration may allow the inclining test of an individual cargo ship to be dispensed with provided basic stability data are available from the inclining test of a sister ship and it is shown to the satisfaction of the Administration that reliable stability information for the exempted ship can be obtained from such basic data, as required by regulation 5-1. A lightweight survey shall be carried out upon completion and the ship shall be inclined whenever in comparison with the data derived from the sister ship, a deviation from the lightship displacement exceeding 1% for ships of 160 m or more in length and 2% for ships of 50 m or less in length and as determined by linear interpolation for intermediate lengths or a deviation from the lightship longitudinal centre of gravity exceeding 0.5% of L_sL is found.

...

5 At periodical intervals not exceeding five years, a lightweight survey shall be carried out on all passenger ships to verify any changes in lightship displacement and longitudinal centre of gravity. The ship shall be re-inclined whenever, in comparison with the approved stability information, a deviation from the lightship displacement exceeding 2% or a deviation of the longitudinal centre of gravity exceeding 1% of L_sL is found or anticipated.

~~* Refer to the Code on Intact Stability for All Types of Ships covered by IMO Instruments, adopted by the Organization by resolution A.749(18), as amended. From 1 July 2010, the International Code on Intact Stability, 2008, adopted by resolution MSC.267(85), is expected to enter into force."~~

Regulation 5-1 – Stability information to be supplied to the master

12 The existing footnote to the title of the regulation is amended to read as follows:

"* Refer also to the *Guidelines for the preparation of intact stability information* (MSC/Circ.456); ~~Guidance on the intact stability of existing tankers during transfer operations~~ (MSC/Circ.706); and the *Revised guidance to the master for avoiding dangerous situations in following and quartering seas* (MSC.1/Circ.1228)."

13 The existing paragraph 2.1 is amended to read as follows:

".1 curves or tables of minimum operational metacentric height (GM) and maximum permissible trim versus draught which assures compliance with the relevant intact and damage stability requirements where applicable, alternatively corresponding curves or tables of the maximum allowable vertical centre of gravity (KG) and maximum permissible trim versus draught, or with the equivalents of either of these curves or tables;"

14 The existing paragraphs 3 and 4 are replaced with the following:

"3 The intact and damage stability information required by regulation 5-1.2 shall be presented as consolidated data and encompass the full operating range of draught and trim. Applied trim values shall coincide in all stability information intended for use on board. Information not required for determination of stability and trim limits should be excluded from this information.

4 If the damage stability is calculated in accordance with regulation 6 to regulation 7-3 and, if applicable, with regulations 8 and 9.8, a stability limit curve is to be determined using linear interpolation between the minimum required *GM* assumed for each of the three draughts *ds*, *dp* and *dl*. When additional subdivision indices are calculated for different trims, a single envelope curve based on the minimum values from these calculations shall be presented. When it is intended to develop curves of maximum permissible *KG* it shall be ensured that the resulting maximum *KG* curves correspond with a linear variation of *GM*.

5 As an alternative to a single envelope curve, the calculations for additional trims may be carried out with one common *GM* for all of the trims assumed at each subdivision draught. The lowest values of each partial index *A_s*, *A_p* and *A_l* across these trims shall then be used in the summation of the attained subdivision index *A* according to regulation 7.1. This will result in one *GM* limit curve based on the *GM* used at each draught. A trim limit diagram showing the assumed trim range shall be developed."

15 The existing paragraph 5 is renumbered and amended to read as follows:

"5.6 When curves or tables of minimum operational metacentric height (*GM*) or maximum allowable *KG* versus draught are not appropriate provided, the master should ensure that the operating condition does not deviate from a studied approved loading conditions, or verify by calculation that the stability criteria requirements are satisfied for this loading condition."

Regulation 6 – Required subdivision index *R**

16 In paragraph 2, the existing chapeau and paragraph 2.2 are amended to read as follows:

"2 For all ships to which the damage stability requirements of this chapter part apply, the degree of subdivision to be provided shall be determined by the required subdivision index *R*, as follows:

...

.2 In the case of cargo ships not less than 80 m in length (*L_s*) and not greater than 100 m in length (*L_s*):

..."

17 The text in the existing paragraph 2.3 is amended to read as follows:

"2.3 In the case of passenger ships:

<i>Persons on Board</i>	<i>R</i>
$N \leq 1,000$	$R = 0.000088 * N + 0.7488$
$1,000 < N \leq 6,000$	$R = 0.0369 * \ln(N + 89.048) + 0.579$
$N > 6,000$	$R = 1 - (C1 * 6,200) / (4 * N + 20,000)$ with: $C1 = 0.8 - (0.25 / 10,000) * (10,000 - N)$

Where:

N = total number of persons on board"

18 The existing paragraph 2.4 is deleted.

Regulation 7 – Attained subdivision index A

19 The first sentence of the existing paragraph 1 is amended to read as follows:

"1 ~~An~~The attained subdivision index A is obtained by the summation of the partial indices A_s , A_p and A_l , (weighted as shown and) calculated for the draughts d_s , d_p and d_l defined in regulation 2 in accordance with the following formula:"

20 The existing paragraphs 2 and 3 are amended to read as follows:

"2 As a minimum, ~~In~~ the calculation of A, ~~the level trim shall be used~~carried out at level trim for the deepest subdivision draught d_s and the partial subdivision draught d_p . The ~~actual~~estimated service trim ~~shall~~may be used for the light service draught d_l . If, in any anticipated service condition within the draught range from d_s to d_l , the trim variation in comparison with the calculated trims is greater than 0.5% of L_s , one or more additional calculations of A are to be ~~submitted~~performed for the same draughts but ~~different~~including sufficient trims ~~so~~ to ensure that, for all intended service conditions, the difference in trim in comparison with the reference trim used for one calculation will be ~~less~~not more than 0.5% of L_s . Each additional calculation of A shall comply with regulation 6.1.

3 When determining the positive righting lever (GZ) of the residual stability curve in the intermediate and final equilibrium stages of flooding, the displacement used should be that of the intact loading condition. All calculations should be done with the ship freely trimming. ~~That is, the constant displacement method of calculation should be used.~~"

Regulation 7-1 – Calculation of the factor p_i

21 In the existing paragraph 1, the text of the notation for the mean transverse distance b is amended to read as follows:

" b = the mean transverse distance in metres measured at right angles to the centreline at the deepest subdivision ~~loadline~~draught between the shell and an assumed vertical plane extended between the longitudinal limits used in calculating the factor p_i and which is a tangent to, or common with, all or part of the outermost portion of the longitudinal bulkhead under consideration. This vertical plane shall be so orientated that the mean transverse distance to the shell is a maximum, but not more than twice the least distance between the plane and the shell. If the upper part of a longitudinal bulkhead is below the deepest subdivision ~~loadline~~draught the vertical plane used for determination of b is assumed to extend upwards to the deepest subdivision waterline. In any case, b is not to be taken greater than $B/2$."

Regulation 7-2 – Calculation of the factor s_i

22 The existing paragraphs 2 to 5 are amended to read as follows:

"2 For passenger ships and cargo ships fitted with cross-flooding devices the factor $s_{intermediate,i}$ is applicable only to passenger ships (for cargo ships $s_{intermediate,i}$ should be taken as unity) and shall be taken as the least of the s -factors obtained from all flooding stages including the stage before equalization, if any, and is to be calculated as follows:

$$s_{intermediate,i} = \left[\frac{GZ_{max}}{0.05} \cdot \frac{Range}{7} \right]^{\frac{1}{4}}$$

where GZ_{max} is not to be taken as more than 0.05 m and $Range$ as not more than 7°. $s_{intermediate,i} = 0$, if the intermediate heel angle exceeds 15° for passenger ships and 30° for cargo ships.

For cargo ships not fitted with cross-flooding devices the factor $s_{intermediate,i}$ is taken as unity, except if the Administration considers that the stability in intermediate stages of flooding may be insufficient, it should require further investigation thereof.

For passenger and cargo ships, where cross-flooding devices are fitted fittings are required, the time for equalization shall not exceed 10 min.

3 The factor $s_{final,i}$ shall be obtained from the formula:

$$s_{final,i} = K \cdot \left[\frac{GZ_{max}}{0.12} \cdot \frac{Range}{16} \right]^{\frac{1}{4}}$$

where:

GZ_{max} is not to be taken as more than 0.12 m;

$Range$ is not to be taken as more than 16°;

$$s_{final,i} = K \cdot \left[\frac{GZ_{max}}{TGZ_{max}} \cdot \frac{Range}{TRange} \right]^{\frac{1}{4}}$$

where:

GZ_{max} is not to be taken as more than TGZ_{max} ;

$Range$ is not to be taken as more than $TRange$;

$TGZ_{max} = 0.20$ m, for ro-ro passenger ships each damage case that involves a ro-ro space,

$TGZ_{max} = 0.12$ m, otherwise;

$TRange = 20^\circ$, for ro-ro passenger ships each damage case that involves a ro-ro space,

$TRange = 16^\circ$, otherwise;

$K = 1$ if $\theta_e \leq \theta_{min}$

$K = 0$ if $\theta_e \geq \theta_{max}$

$$K = \sqrt{\frac{\theta_{max} - \theta_e}{\theta_{max} - \theta_{min}}} \text{ otherwise,}$$

where:

θ_{min} is 7° for passenger ships and 25° for cargo ships; and

θ_{max} is 15° for passenger ships and 30° for cargo ships.

4 The factor $s_{mom,i}$ is applicable only to passenger ships (for cargo ships $s_{mom,i}$ shall be taken as unity) and shall be calculated at the final equilibrium from the formula:

$$s_{mom,i} = \frac{(GZ_{max} - 0.04) \cdot Displacement}{M_{heel}}$$

where:

Displacement is the intact displacement at the subdivision respective draught (d_s , d_p or d_l).

M_{heel} is the maximum assumed heeling moment as calculated in accordance with subparagraph 4.1; and

$$s_{mom,i} \leq 1$$

4.1 The heeling moment M_{heel} is to be calculated as follows:

$$M_{heel} = \text{maximum} (M_{passenger} \text{ or } M_{wind} \text{ or } M_{survivalcraft})$$

4.1.1 $M_{passenger}$ is the maximum assumed heeling moment resulting from movement of passengers, and is to be obtained as follows:

$$M_{passenger} = (0.075 \cdot N_p) \cdot (0.45 \cdot B) \text{ (tm)}$$

where:

N_p is the maximum number of passengers permitted to be on board in the service condition corresponding to the deepest subdivision draught under consideration; and

B is the beam breadth of the ship as defined in regulation 2.8.

Alternatively, the heeling moment may be calculated assuming the passengers are distributed with 4 persons per square metre on available deck areas towards one side of the ship on the decks where muster stations are located and in such a way that they produce the most adverse heeling moment. In doing so, a weight of 75 kg per passenger is to be assumed.

4.1.2 M_{wind} is the maximum assumed wind ~~forcemoment~~ acting in a damage situation:

$$M_{wind} = (P \cdot A \cdot Z) / 9,806 \text{ (tm)}$$

where:

$$P = 120 \text{ N/m}^2;$$

A = projected lateral area above waterline;

Z = distance from centre of lateral projected area above waterline to $T/2$; and

T = ~~ship's~~ respective draught, (d_s , d_p or d_{ij}).

...

5 Unsymmetrical flooding is to be kept to a minimum consistent with the efficient arrangements. Where it is necessary to correct large angles of heel, the means adopted shall, where practicable, be self-acting, but in any case where controls to equalization devices are provided they shall be operable from above the bulkhead deck of passenger ships and the freeboard deck of cargo ships. These fittings together with their controls shall be acceptable to the Administration.* Suitable information concerning the use of equalization devices shall be supplied to the master of the ship.

* Reference is made to the "~~Revised Recommendation on a standard method for establishing compliance with the requirements for evaluating cross-flooding arrangements in passenger ships~~", adopted by the Organization by resolution ~~A.266(VIII)~~MSC.362(92), as may be amended.

...

5.2 ~~In all cases,~~ The factor s_i is to be taken as zero in those cases where the final waterline, taking into account sinkage, heel and trim, immerses:

...

5.3 The factor s_i is to be taken as zero if, taking into account sinkage, heel and trim, any of the following occur in any intermediate stage or in the final stage of flooding:

- .1 immersion of any vertical escape hatch in the bulkhead deck of passenger ships and the freeboard deck of cargo ships intended for compliance with chapter II-2;

- .2 any controls intended for the operation of watertight doors, equalization devices, valves on piping or on ventilation ducts intended to maintain the integrity of watertight bulkheads from above the bulkhead deck of passenger ships and the freeboard deck of cargo ships become inaccessible or inoperable; and
- .3 immersion of any part of piping or ventilation ducts located within the assumed extent of damage and carried through a watertight boundary that is located within any compartment included in damage cases contributing to the attained index A , if not fitted with watertight means of closure at each boundary, if this can lead to the progressive flooding of compartments not assumed as flooded.

...

5.5 Except as provided in paragraph 5.3.1, openings closed by means of watertight manhole covers and flush scuttles, small watertight hatch covers, remotely operated sliding watertight doors, sidescuttles of the non-opening type as well as watertight access doors and watertight hatch covers required to be kept closed at sea need not be considered."

Regulation 8 – Special requirements concerning passenger ship stability

23 The existing paragraphs 1 to 3 are amended to read as follows:

"1 A passenger ship intended to carry 400 or more persons shall have watertight subdivision abaft the collision bulkhead so that $s_i = 1$ for a damage involving all the compartments within $0.08L$ measured from the forward perpendicular for the three loading conditions used to calculate the attained A , which is based on the calculation of the subdivision index A , and for a damage involving all the compartments within $0.08L$ measured from the forward perpendicular. If the attained subdivision index A is calculated for different trims, this requirement must also be satisfied for those loading conditions.

2 A passenger ship intended to carry 36 or more persons is to be capable of withstanding damage along the side shell to an extent specified in paragraph 3. Compliance with this regulation is to be achieved by demonstrating that s_i , as defined in regulation 7-2, is not less than 0.9 for the three loading conditions used to calculate the attained A , which is based on the calculation of the subdivision index A . If the attained subdivision index A is calculated for different trims, this requirement must also be satisfied for those loading conditions.

3 The damage extent to be assumed when demonstrating compliance with paragraph 2, is to be dependent on both N as defined in regulation 6 the total number of persons carried, and L_s as defined in regulation 2, such that:

...

- .2 where 400 or more persons are to be carried, a damage length of $0.03L_s$, but not less than 3 m is to be assumed at any position along the side shell, in conjunction with a penetration inboard of $0.1B$ but not less than 0.75 m measured inboard from the ship side, at right angles to the centreline at the level of the deepest subdivision draught;

...

- .4 where 36 persons are carried, a damage length of $0.015L_s$ but not less than 3 m is to be assumed, in conjunction with a penetration inboard of $0.05B$ but not less than 0.75 m; and"

Regulation 8-1 – System capabilities and operational information after a flooding casualty on passenger ships

- 24 In section 2, the existing text is amended to read as follows:

"A passenger ship ~~constructed on or after 1 July 2010~~ shall be designed so that the systems specified in regulation II-2/21.4 remain operational when the ship is subject to flooding of any single watertight compartment."

- 25 In section 3, the existing chapeau is amended to read as follows:

"For the purpose of providing operational information to the Master for safe return to port after a flooding casualty, passenger ships ~~constructed on or after 1 January 2014~~ shall have:"

PART B-2

SUBDIVISION, WATERTIGHT AND WEATHERTIGHT INTEGRITY

Regulation 9 – Double bottoms in passenger ships and cargo ships other than tankers

- 26 The existing paragraph 3 is amended to read as follows:

3.1 Small wells constructed in the double bottom in connection with drainage arrangements ~~of holds, etc.~~ shall not extend downward more than necessary. The vertical distance from the bottom of such a well to a plane coinciding with the keel line shall not be less than $h/2$ or 500 mm, whichever is greater, or compliance with paragraph 8 of this regulation shall be shown for that part of the ship. ~~A well extending to the outer bottom is, however, permitted at the after end of the shaft tunnel.~~

3.2 Other wells (e.g. for lubricating oil under main engines) may be permitted by the Administration if satisfied that the arrangements give protection equivalent to that afforded by a double bottom complying with this regulation. ~~In no case shall the vertical distance from the bottom of such a well to a plane coinciding with the keel line be less than 500 mm.~~

3.2.1 For a cargo ship of 80 m in length and upwards or for a passenger ship, proof of equivalent protection is to be shown by demonstrating that the ship is capable of withstanding bottom damages as specified in paragraph 8. Alternatively, wells for lubricating oil below main engines may protrude into the double bottom below the boundary line defined by the distance h provided that the vertical distance between the well bottom and a plane coinciding with the keel line is not less than $h/2$ or 500 mm, whichever is greater.

3.2.2 For cargo ships of less than 80 m in length the arrangements shall provide a level of safety satisfactory to the Administration."

27 The existing paragraphs 6 to 8 are amended to read as follows:

"6 Any part of a cargo ship of 80 m in length and upwards or of a passenger ship ~~or a cargo ship~~ that is not fitted with a double bottom in accordance with paragraphs 1, 4 or 5, as specified in paragraph 2, shall be capable of withstanding bottom damages, as specified in paragraph 8, in that part of the ship. For cargo ships of less than 80 m in length the alternative arrangements shall provide a level of safety satisfactory to the Administration.

7 In the case of unusual bottom arrangements in a cargo ship of 80 m in length and upwards or a passenger ship ~~or a cargo ship~~, it shall be demonstrated that the ship is capable of withstanding bottom damages as specified in paragraph 8. For cargo ships of less than 80 m in length the alternative arrangements shall provide a level of safety satisfactory to the Administration.

8 Compliance with paragraphs 3.1, 3.2.1, 6 or 7 is to be achieved by demonstrating that s_i , when calculated in accordance with regulation 7-2, is not less than 1 for all service conditions when subject to a bottom damage ~~assumed at any position along the ship's bottom and~~ with an extent specified in subparagraph .2 below ~~for any position in the affected part of the ship:~~

- .1 Flooding of such spaces shall not render emergency power and lighting, internal communication, signals or other emergency devices inoperable in other parts of the ship.
- .2 Assumed extent of damage shall be as follows:

	For 0.3 L from the forward perpendicular of the ship	Any other part of the ship
Longitudinal extent	$1/3 L^{2/3}$ or 14.5 m, whichever is less	$1/3 L^{2/3}$ or 14.5 m, whichever is less
Transverse extent	$B/6$ or 10 m, whichever is less	$B/6$ or 5 m, whichever is less
Vertical extent, measured from the keel line	$B/20$ or 2 m, whichever is less <u>$B/20$, to be taken not less than 0.76 m and not more than 2 m</u>	$B/20$ or 2 m, whichever is less <u>$B/20$, to be taken not less than 0.76 m and not more than 2 m</u>

- .3 If any damage of a lesser extent than the maximum damage specified in .2 would result in a more severe condition, such damage should be considered."

Regulation 10 – Construction of watertight bulkheads

28 The existing paragraph 1 is amended to read as follows:

"1 Each watertight subdivision bulkhead, whether transverse or longitudinal, shall be constructed having scantlings as specified in regulation 2.17. In all cases, watertight subdivision bulkheads shall be capable of supporting at least the pressure due to a head of water up to the bulkhead deck in passenger ships and freeboard deck in cargo ships."

Regulation 12 – Peak and machinery space bulkheads, shaft tunnels, etc.

29 The existing paragraph 1 is amended to read as follows:

"1 A collision bulkhead shall be fitted which shall be watertight up to the bulkhead deck in passenger ships and freeboard deck in cargo ships. This bulkhead shall be located at a distance from the forward perpendicular of not less than $0.05L$ or 10 m, whichever is the less, and, except as may be permitted by the Administration, not more than $0.08L$ or $0.05L + 3$ m, whichever is the greater."

30 The following new paragraph 2 is introduced after the existing paragraph 1:

"2 The ship shall be so designed that s_i calculated in accordance with regulation 7-2 will not be less than 1 at the deepest subdivision draught loading condition, level trim or any forward trim loading conditions, if any part of the ship forward of the collision bulkhead is flooded without vertical limits."

31 The remaining paragraphs are renumbered and amended to read as follows:

"23 Where any part of the ship below the waterline extends forward of the forward perpendicular, e.g. a bulbous bow, the distances stipulated in paragraph 1 shall be measured from a point either:

- .1 at the mid-length of such extension;
- .2 at a distance $0.015L$ forward of the forward perpendicular; or
- .3 at a distance 3 m forward of the forward perpendicular,

whichever gives the smallest measurement.

34 The bulkhead may have steps or recesses provided they are within the limits prescribed in paragraph 1 or 32.

45 No doors, manholes, access openings, ventilation ducts or any other openings shall be fitted in the collision bulkhead below the bulkhead deck in passenger ships and freeboard deck in cargo ships.

56.1 Except as provided in paragraph 65.2, the collision bulkhead may be pierced below the bulkhead deck in passenger ships and freeboard deck in cargo ships by not more than one pipe for dealing with fluid in the forepeak tank, provided that the pipe is fitted with a screw-down valve capable of being operated from above the bulkhead deck in passenger ships and freeboard deck in cargo ships, the valve chest—being secured—located inside the forepeak ~~at~~ the collision bulkhead. The Administration may, however, authorize the fitting of this valve on the after side of the collision bulkhead provided that the valve is readily accessible under all service conditions and the space in which it is located is not a cargo space. Alternatively, for cargo ships, the pipe may be fitted with a butterfly valve suitably supported by a seat or flanges and capable of being operated from above the freeboard deck. All valves shall be of steel, bronze or other approved ductile material. Valves of ordinary cast iron or similar material are not acceptable.

56.2 If the forepeak is divided to hold two different kinds of liquids the Administration may allow the collision bulkhead to be pierced below the bulkhead deck in passenger ships and freeboard deck in cargo ships by two pipes, each of which is fitted as required by paragraph 65.1, provided the Administration is satisfied that there is no practical alternative to the fitting of such a second pipe and that, having regard to the additional subdivision provided in the forepeak, the safety of the ship is maintained.

67 Where a long forward superstructure is fitted, the collision bulkhead shall be extended weathertight to the deck next above the bulkhead deck in passenger ships and freeboard deck in cargo ships. The extension need not be fitted directly above the bulkhead below provided it is that all parts of the extension, including any part of the ramp attached to it are located within the limits prescribed in paragraph 1 or 32, with the exception permitted by paragraph 87 and that the part of the deck which forms the step is made effectively weathertight. The extension shall be so arranged as to preclude the possibility of the bow door or ramp, where fitted, causing damage to it in the case of damage to, or detachment of, a bow door or any part of the ramp.

78 Where bow doors are fitted and a sloping loading ramp forms part of the extension of the collision bulkhead above the bulkhead deck in passenger ships and freeboard deck in cargo ships the ramp shall be weathertight over its complete length. In cargo ships the part of the ramp which is more than 2.3 m above the bulkhead freeboard deck may extend forward of the limit specified in paragraph 1 or 23. Ramps not meeting the above requirements shall be disregarded as an extension of the collision bulkhead.

89 The number of openings in the extension of the collision bulkhead above the freeboard deck shall be restricted to the minimum compatible with the design and normal operation of the ship. All such openings shall be capable of being closed weathertight.

910 Bulkheads shall be fitted separating the machinery space from cargo and accommodation spaces forward and aft and made watertight up to the bulkhead deck in passenger ships and freeboard deck in cargo ships. In passenger ships a An afterpeak bulkhead shall also be fitted and made watertight up to the bulkhead deck or the freeboard deck. The afterpeak bulkhead may, however, be stepped below the bulkhead deck or the freeboard deck, provided the degree of safety of the ship as regards subdivision is not thereby diminished.

1011 In all cases stern tubes shall be enclosed in watertight spaces of moderate volume. In passenger ships the stern gland shall be situated in a watertight shaft tunnel or other watertight space separate from the stern tube compartment and of such volume that, if flooded by leakage through the stern gland, the bulkhead deck will not be immersed. In cargo ships other measures to minimize the danger of water penetrating into the ship in case of damage to stern tube arrangements may be taken at the discretion of the Administration."

Regulation 13 – Openings in watertight bulkheads below the bulkhead deck in passenger ships

32 The existing paragraph 11.1 is amended to read as follows:

"11.1 Where trunkways or tunnels for access from crew accommodation to the ~~stowhold~~ machinery spaces, for piping, or for any other purpose are carried through watertight bulkheads, they shall be watertight and in accordance with the requirements of regulation 16-1. The access to at least one end of each such tunnel or trunkway, if used as a passage at sea, shall be through a trunk extending watertight to a height sufficient to permit access above the bulkhead deck. The access to the other end of the trunkway or tunnel may be through a watertight door of the type required by its location in the ship. Such trunkways or tunnels shall not extend through the first subdivision bulkhead abaft the collision bulkhead."

Regulation 15 – Openings in the shell plating below the bulkhead deck of passenger ships and the freeboard deck of cargo ships

33 The existing paragraphs 4, 5.1, 8.2.1 and 8.4 are amended to read as follows:

"4 Efficient hinged inside deadlights so arranged that they can be easily and effectively closed and secured watertight, shall be fitted to all sidescuttles except that abaft one eighth of the ship's length from the forward perpendicular and above a line drawn parallel to the bulkhead deck at side and having its lowest point at a height of 3.7 m plus 2.5% of the breadth of the ship above the deepest subdivision draught, the deadlights may be portable in passenger accommodation ~~other than that for storage~~ ~~passengers~~, unless the deadlights are required by the International Convention on Load Lines in force to be permanently attached in their proper positions. Such portable deadlights shall be stowed adjacent to the sidescuttles they serve.

...

5.1 No sidescuttles shall be fitted in any spaces which are appropriated exclusively to the carriage of cargo ~~or coal~~.

...

8.2.1 Subject to the requirements of the International Convention on Load Lines in force, and except as provided in paragraph 8.3, each separate discharge led through the shell plating from spaces below the bulkhead deck of passenger ships and the freeboard deck of cargo ships shall be provided with either one automatic non-return valve fitted with a positive means of closing it from above the bulkhead deck of passenger ships and the freeboard deck of cargo ships or with two automatic non-return valves without positive means of closing, provided that the inboard valve is situated above the deepest subdivision draught and is always accessible for examination under service conditions. Where a valve with positive means of closing is fitted, the operating position above the bulkhead deck of passenger ships and the freeboard deck of cargo ships shall always be readily accessible and means shall be provided for indicating whether the valve is open or closed.

...

8.4 Moving parts penetrating the shell plating below the deepest subdivision draught shall be fitted with a watertight sealing arrangement acceptable to the Administration. The inboard gland shall be located within a watertight space of such volume that, if flooded, the bulkhead deck in passenger ships and freeboard deck in cargo ships will not be submerged. The Administration may require that if such compartment is flooded, essential or emergency power and lighting, internal communication, signals or other emergency devices must remain available in other parts of the ship."

Regulation 16 – Construction and initial tests of watertight doors, sidescuttles, etc.

34 The title of the regulation is amended to read as follows:

**"Regulation 16 – Construction and initial tests of watertight ~~closure doors,~~
sidescuttles, etc."**

35 The existing paragraphs 1 and 2 are amended to read as follows:

~~"1~~ ~~—~~ In all ships:

1.1 The design, materials and construction of all watertight closures such as doors, hatches, sidescuttles, gangway and cargo ports, valves, pipes, ash-chutes and rubbish-chutes referred to in these regulations shall be to the satisfaction of the Administration;

1.2 Such valves, doors, hatches, and mechanisms shall be suitably marked to ensure that they may be properly used to provide maximum safety; and

1.3 The frames of vertical watertight doors shall have no groove at the bottom in which dirt might lodge and prevent the door closing properly.

2 ~~In passenger ships and cargo ships—~~ Watertight doors and hatches shall be tested by water pressure to the maximum head of water they might sustain in a final or intermediate stage of flooding. For cargo ships not covered by damage stability requirements, watertight doors and hatches shall be tested by water pressure to a head of water measured from the lower edge of the opening to one metre above the freeboard deck. Where testing of individual doors and hatches is not carried out because of possible damage to insulation or outfitting items, testing of individual doors and hatches may be replaced by a prototype pressure test of each type and size of door or hatch with a test pressure corresponding at least to the head required for the individual location. The prototype test shall be carried out before the door or hatch is fitted. The installation method and procedure for fitting the door or hatch on board shall correspond to that of the prototype test. When fitted on board, each door or hatch shall be checked for proper seating between the bulkhead, the frame and the door or between deck, the coaming and the hatch."

Regulation 16-1 – Construction and initial tests of watertight decks, trunks, etc.

36 The existing paragraphs 2 and 3 are amended to read as follows:

"2 In passenger ships, ~~W~~where a ventilation trunk passing through a structure penetrates a watertight area of the bulkhead deck, the trunk shall be capable of withstanding the water pressure that may be present within the trunk, after having taken into account the maximum heel angle ~~allowable~~ during ~~intermediate stages of~~ flooding, in accordance with regulation 7-2.

3 In ro-ro passenger ships, ~~W~~where all or part of the penetration of the bulkhead deck is on the main ro-ro deck, the trunk shall be capable of withstanding impact pressure due to internal water motions (sloshing) of water trapped on the ro-ro deck."

Regulation 17 – Internal watertight integrity of passenger ships above the bulkhead deck

37 The existing paragraph 3 is amended to read as follows:

"3 ~~The open end of a~~Air pipes terminating within a superstructure which are not fitted with watertight means of closure shall be considered as unprotected openings when applying regulation 7-2.6.1.1. ~~shall be at least 1 m above the waterline when the ship heels to an angle of 15°, or the maximum angle of heel during intermediate stages of flooding, as determined by direct calculation, whichever is the greater. Alternatively, air pipes from tanks other than oil tanks may discharge through the side of the superstructure. The provisions of this paragraph are without prejudice to the provisions of the International Convention on Load Lines in force.~~"

PART B-4 STABILITY MANAGEMENT

Regulation 19 – Damage control information

38 The existing paragraph 2 is deleted and remaining paragraphs are renumbered accordingly.

39 The following new regulation 19-1 is introduced after the existing regulation 19:

"Regulation 19-1 – Damage control drills for passenger ships

1 This regulation applies to passenger ships constructed before, on or after 1 January 2020.

2 A damage control drill shall take place at least every three months. The entire crew need not participate in every drill, but only those crew members with damage control responsibilities.

3 The damage control drill scenarios shall vary each drill so that emergency conditions are simulated for different damage conditions and shall, as far as practicable, be conducted as if there were an actual emergency.

- 4 Each damage control drill shall include:
- .1 for crew members with damage control responsibilities, reporting to stations and preparing for the duties described in the muster list required by regulation III/8;
 - .2 use of the damage control information and the onboard damage stability computer, if fitted, to conduct stability assessments for the simulated damage conditions;
 - .3 establishment of the communications link between the ship and shore-based support, if provided;
 - .4 operation of watertight doors and other watertight closures;
 - .5 demonstrating proficiency in the use of the flooding detection system, if fitted, in accordance with muster list duties;
 - .6 demonstrating proficiency in the use of cross-flooding and equalization systems, if fitted, in accordance with muster list duties;
 - .7 operation of bilge pumps and checking of bilge alarms and automatic bilge pump starting systems; and
 - .8 instruction in damage survey and use of the ship's damage control systems.

5 At least one damage control drill each year shall include activation of the shore-based support, if provided in compliance with regulation II-1/8-1.3, to conduct stability assessments for the simulated damage conditions.

6 Every crew member with assigned damage control responsibilities shall be familiarized with their duties and about the damage control information before the voyage begins.

7 A record of each damage control drill shall be maintained in the same manner as prescribed for the other drills in regulation III/19.5."

40 The existing title and paragraph 1 of regulation 20 are amended to read as follows:

"Regulation 20 – Loading of ~~passenger~~ ships

1 On completion of loading of the ship and prior to its departure, the master shall determine the ship's trim and stability and also ascertain and record that the ship is upright and in compliance with stability criteria in relevant regulations. The determination of the ship's stability shall always be made by calculation or by ensuring that the ship is loaded according to one of the pre-calculated loading conditions within the approved stability information. The Administration may accept the use of an electronic loading and stability computer or equivalent means for this purpose."

Regulation 21 – Periodical operation and inspection of watertight doors, etc. in passenger ships

41 The text of the existing paragraph 1 is amended to read as follows:

"~~Drills for the operating~~Operational tests of watertight doors, sidescuttles, valves and closing mechanisms of scuppers, ash-chutes and rubbish-chutes shall take place weekly. In ships in which the voyage exceeds one week in duration a complete ~~drill set~~ of operational tests shall be held before ~~leaving port~~the voyage commences, and others thereafter at least once a week during the voyage."

42 The text of the existing paragraph 4 is amended to read as follows:

"A record of all ~~drills~~operational tests and inspections required by this regulation shall be entered in the logbook with an explicit record of any defects which may be disclosed."

Regulation 22 – Prevention and control of water ingress, etc.

43 In the existing paragraph 1, the words "and 4" are removed from the end of the first sentence.

44 The existing paragraph 2 is amended to read as follows:

"2 Watertight doors located below the bulkhead deck in passenger ships and freeboard deck in cargo ships having a maximum clear opening width of more than 1.2 m shall be kept closed when the ship is at sea, except for limited periods when absolutely necessary as determined by the Administration."

45 The new footnote to existing paragraph 3 is added as follows:

"3 A watertight door may be opened during navigation to permit the passage of passengers or crew, or when work in the immediate vicinity of the door necessitates it being opened. The door must be immediately closed when transit through the door is complete or when the task which necessitated it being open is finished.*

* Refer to the *Guidance for watertight doors on passenger ships which may be opened during navigation* (MSC.1/Circ.[...])."

46 The existing paragraph 4 is deleted and the subsequent paragraphs are renumbered accordingly.

47 The existing paragraphs 5 to 7 are amended to read as follows:

"5 Portable plates on bulkheads shall always be in place before the ~~ship leaves port~~voyage commences, and shall not be removed during navigation except in case of urgent necessity at the discretion of the master. The necessary precautions shall be taken in replacing them to ensure that the joints are watertight. Power-operated sliding watertight doors permitted in machinery spaces in accordance with regulation 13.10 shall be closed before the ~~ship leaves port~~voyage commences and shall remain closed during navigation except in case of urgent necessity at the discretion of the master.

6 Watertight doors fitted in watertight bulkheads dividing cargo between deck spaces in accordance with regulation 13.9.1 shall be closed before the voyage commences and shall be kept closed during navigation. ~~†The time of opening such doors in port are opened or closed and of closing them before the ship leaves port shall be entered in the log-book.~~

7 Gangway, cargo and fuelling ports fitted below the bulkhead deck in passenger ships and freeboard deck in cargo ships shall be effectively closed and secured watertight before the ship leaves port, and shall be kept closed during navigation."

48 In paragraph 8, the existing chapeau is amended to read as follows:

"8 The following doors, located above the bulkhead deck in passenger ships and freeboard deck in cargo ships, shall be closed and locked before the ship proceeds on any voyage and shall remain closed and locked until the ship is at its next berth:"

49 The existing paragraph 14 is amended to read as follows:

"14 Where in a between-deck, the sills of any of the sidescuttles referred to in regulation 15.3.2 are below a line drawn parallel to the bulkhead deck at side in passenger ships and freeboard deck at side in cargo ships, and having its lowest point 1.4 m plus 2.5% of the breadth of the ship above the water when the ship departs from any port, all the sidescuttles in that between-decks shall be closed watertight and locked before the ship leaves port, and they shall not be opened before the ship arrives at the next port. In the application of this paragraph the appropriate allowance for fresh water may be made when applicable.

- .1 The time of opening such sidescuttles in port and of closing and locking them before the ship leaves port shall be entered in such log-book as may be prescribed by the Administration.
- .2 For any ship that has one or more sidescuttles so placed that the requirements of paragraph 14 would apply when it was floating at its deepest subdivision draught, the Administration may indicate the limiting mean draught at which these sidescuttles will have their sills above the line drawn parallel to the bulkhead deck at side in passenger ships and freeboard deck at side in cargo ships, and having its lowest point 1.4 m plus 2.5% of the breadth of the ship above the waterline corresponding to the limiting mean draught, and at which it will therefore be permissible to depart from port without previously closing and locking them and to open them at sea on the responsibility of the master during the voyage to the next port. In tropical zones as defined in the International Convention on Load Lines in force, this limiting draught may be increased by 0.3 m."

50 In regulation 22-1, the words "constructed on or after 1 July 2010" are removed from the end of the existing title.

51 In regulation 24, the existing title and paragraph 3 are amended to read as follows:

"Regulation 24 – Additional requirements for Prevention and control of water ingress, etc. in cargo ships

...

3 Watertight doors or ramps fitted to internally subdivide large cargo spaces shall be closed before the voyage commences and shall be kept closed during navigation. ~~†The time of opening such doors in port are opened or closed and of closing them before the ship leaves port shall be entered in the log-book."~~

PART C
MACHINERY INSTALLATIONS

Regulation 35-1 – Bilge pumping arrangements

52 The following new sentence is added at the end of the existing paragraph 2.6:

"For ships subject to the provisions of regulation II-1/1.1.1.1, for the special hazards associated with loss of stability when fitted with fixed pressure water-spraying fire-extinguishing systems see II-2/20.6.1.4."

53 In paragraph 3.2, the existing text of the whole volume of the passenger and crew spaces below the bulkhead deck *P* is amended to read as follows:

"*P* = the whole volume of the passenger and crew spaces below the bulkhead deck (cubic metres), which are provided for the accommodation and use of passengers and crew, excluding baggage, store, and provision ~~and mail~~ rooms;"

54 In paragraph 3.4, the existing chapeau is amended to read as follows:

"3.4 On a ship of 91.5 m in length *L* and upwards or having a bilge pump numeral, calculated in accordance with paragraph 3.2, of 30 or more, the arrangements shall be such that at least one power bilge pump shall be available for use in all flooding conditions which the ship is required to withstand, and, for ships subject to the provisions of regulation II-1/1.1.1.1, in all flooding conditions derived from consideration of minor damages as specified in regulation 8 ~~which the ship is required to withstand~~ as follows:"

55 The following new sentence is added at the end of the existing paragraph 3.10:

"For ships subject to the provisions of regulation II-1/1.1.1.1, the deepest subdivision load line shall be taken as the deepest subdivision draught."

4 ALBERT EMBANKMENT
LONDON SE1 7SR
Telephone: +44 (0)20 7735 7611 Fax: +44 (0)20 7587 3210

MSC.1/Circ.1518
13 May 2016

**INTERNATIONAL CONVENTION FOR THE SAFETY OF LIFE AT SEA
(SOLAS), 1974, AS AMENDED**

Promulgation of rules for the design and construction of bulk carriers and oil tankers of an organization, which is recognized by Administrations in accordance with the provisions of SOLAS regulation XI-1/1, confirmed by the Maritime Safety Committee to be in conformity with the goals and functional requirements of the Goal-based Ship Construction Standards for Bulk Carriers and Oil Tankers

1 The Maritime Safety Committee (MSC), at its ninety-sixth session (11 to 20 May 2016), received the verification audit reports of the audit teams for the 12 Submitters, which are organizations recognized by Administrations in accordance with the provisions of SOLAS regulation XI-1/1, from the Secretary-General, pursuant to the *Guidelines for verification of conformity with goal-based ship construction standards for bulk carriers and oil tankers* (resolution MSC.296(87)) (GBS Guidelines). The Committee also received the Corrective Action Plans from the above-mentioned 12 Submitters, in response to the non-conformities and observations documented in the verification reports of the audit teams.

2 Having considered the verification audit reports and the Corrective Action Plans referred to above, the Committee confirmed that the information provided by the 12 Submitters demonstrates that, in accordance with SOLAS regulation II-1/3-10.3, their rules conform to the International goal-based ship construction standards for bulk carriers and oil tankers (resolution MSC.287(87)) (GBS Standards); and that ships contracted under the current Submitters' verified rules are deemed to meet the GBS Standards.

3 The list set out in the annex contains those 12 Submitters, i.e. a list of organizations, which are recognized by Administrations in accordance with the provisions of SOLAS regulation XI-1/1, whose rules have been verified as conforming to the goals and functional requirements of the GBS Standards.

4 Where non-conformities have been identified in the verification audit reports, the Committee agreed that such non-conformities are to be rectified and that the 12 Submitters submit new requests for a verification audit on the rectification of non-conformities. Where observations have been identified in the verification audit reports, the Committee requested that the ROs address the identified observations and that the ROs submit the outcomes in the future.

5 The Committee also noted that, as a new request for the verification audit of an organization's rules for the design and construction of bulk carriers and oil tankers may be made to the Secretary-General at any time, other organization(s) may be added to the list set out in the annex at subsequent sessions.

6 The Committee draws the attention of maritime Administrations, shipyards, shipowners, ship designers, ship operators and managers, ship masters and all other stakeholders concerned to the list of organizations recognized by Administrations in accordance with the provisions of SOLAS regulation XI-1/1, whose rules have been verified as conforming to the goals and functional requirements of the *International Goal-based Ship Construction Standards for Bulk Carriers and Oil Tankers* (resolution MSC.287(87)).

ANNEX

LIST OF ORGANIZATIONS, WHICH ARE RECOGNIZED BY ADMINISTRATIONS IN ACCORDANCE WITH THE PROVISIONS OF SOLAS REGULATION XI-1/1, WHOSE RULES HAVE BEEN VERIFIED AS CONFORMING TO THE GOALS AND FUNCTIONAL REQUIREMENTS OF THE GOAL-BASED SHIP CONSTRUCTION STANDARDS FOR BULK CARRIERS AND OIL TANKERS

Recognized Organization	Date of confirmation	Session of MSC
American Bureau of Shipping (ABS)	11 May 2016	MSC 96
Bureau Veritas (BV)	11 May 2016	MSC 96
China Classification Society (CCS)	11 May 2016	MSC 96
Croatian Register of Shipping (CRS)	11 May 2016	MSC 96
DNV GL	11 May 2016	MSC 96
Indian Register of Shipping (IRS)	11 May 2016	MSC 96
Korean Register of Shipping (KR)	11 May 2016	MSC 96
Lloyd's Register (LR)	11 May 2016	MSC 96
Nippon Kaiji Kyokai (ClassNK)	11 May 2016	MSC 96
Polish Register of Shipping (PRS)	11 May 2016	MSC 96
RINA Services (RINA)	11 May 2016	MSC 96
Russian Maritime Register of Shipping (RS)	11 May 2016	MSC 96

4 ALBERT EMBANKMENT
LONDON SE1 7SR
Telephone: +44 (0)20 7735 7611 Fax: +44 (0)20 7587 3210

MSC.1/Circ.1519
6 June 2016

**GUIDANCE ON METHODOLOGIES FOR ASSESSING OPERATIONAL CAPABILITIES
AND LIMITATIONS IN ICE**

1 The Maritime Safety Committee, at its ninety-fourth session (17 to 21 November 2014), adopted the new chapter XIV of SOLAS and the International Code for Ships Operating in Polar Waters (Polar Code), by resolutions MSC.386(94) and MSC.385(94), respectively. In accordance with the Polar Code, new and existing ships operating in polar waters shall have on board a valid Polar Ship Certificate establishing operational limitations, including limitations related to ship structural ice capabilities.

2 The Polar Code also requires that information on ship-specific capabilities and limitations in relation to the assessment required under section 1.5 of the Polar Code be included in the Polar Water Operational Manual (PWOM).

3 The annexed guidance addresses the development of methodologies for the assessment of operational limitations in ice which may be referenced on the Polar Ship Certificate and which may form part of information on ship-specific capabilities and limitations included in the PWOM.

4 This guidance has been issued as "interim guidance" in order to gain experience in its use. It should be reviewed four years after the entry into force of the Polar Code in order to make any necessary amendments based on experience gained.

5 In the meantime, Member States and international organizations are invited to report on their experience with the use of the guidance to the Maritime Safety Committee under the agenda item "Any other business".

6 Member States are invited to bring the annexed guidance to the attention of all parties concerned.

ANNEX

GUIDANCE ON METHODOLOGIES FOR ASSESSING OPERATIONAL CAPABILITIES AND LIMITATIONS IN ICE

1 Introduction

1.1 In order to maintain an acceptable level of risk under different ice regimes and types of operation in ice, voyage planning and operation should take into account ship structural capability, ship characteristics, type of operation and current and expected ice conditions. Where applicable, the Polar Ship Certificate should reference a practical methodology for assessing the operational capabilities and limitations in ice.

1.2 Ice class, if any, is included in the Polar Ship Certificate and gives information on structural capability. This provides the basis for assessing limiting ice conditions and determining acceptable safe operating procedures.

1.3 This guidance addresses the development of methodologies for assessing the structural capabilities and limitations in different ice regimes and operational modes when the ship is operating in ice. It may also be used as a tool for voyage planning. At the design stage, ice class selection may also be assessed by matching the anticipated ice conditions to this guidance

1.4 Any system or methodology for assessing structural capabilities and limitations based on this guidance should not be interpreted as a "Go/No Go" tool but as a decision support tool. The decision for operating in specific ice regimes should be based on the consideration of personnel on board qualified in accordance with chapter 12 of the Polar Code, taking into account the condition and characteristics of the ship; current and forecasted environmental conditions, including type and concentration of ice, sea state and visibility; and an understanding of the anticipated ship-ice interactions.

1.5 Currently, there are well established national shipping systems such as Canada's Arctic Ice Regime Shipping System and the Russian Ice Certificate. This guidance is aimed at making use of that experience to assist shipboard personnel, companies and administrations.

2 Definitions

For the purpose of this guidance, in addition to the definitions in the Polar Code, the following definition applies:

Ice regime means a description of an area with a relatively consistent distribution of any mix of ice types, including open water.

3 General

3.1 Ships operating in ice should be provided with a practical methodology to assess their limitations for specific operational conditions. The methodology should take into account:

- .1 hull structural capability to resist ice load and the capability of the propulsion machinery, rudders and steering gear to resist ice loads;
- .2 ice regimes;
- .3 independent or escorted operations; and
- .4 ice decay in warmer ambient temperatures.

3.2 To determine and record the limitations for operating in ice in the Polar Ship Certificate, acceptance criteria should be established whereby the risk of structural damage and/or loss of watertight integrity are effectively assessed against the ice conditions and modes of operation for the intended area of operation.

3.3 Assessments should be practical and intended to be used on board prior to, and during polar water operation and/or transit. Masters, chief mates and officers in charge of a navigational watch should receive suitable training in the use of any system or methodology used for assessing the ship's limitations in ice. Practical examples on the use of the methodology should be included in the Polar Water Operational Manual (PWOM).

3.4 Where applicable, the methodology used for setting operational limitations should be referenced on the Polar Ship Certificate¹.

4 Acceptance of methodologies

4.1 The appendix includes an acceptable methodology for assessing limitations for ships operating in ice.

4.2 Alternative methodologies to that contained in the appendix may be accepted provided that they meet the content described above.

4.3 Alternative methodologies should have a means to describe limiting ice conditions using tables and/or curves based on ice concentration, ice type and stage of ice decay.

4.4 For ships with no ice class, measures that will keep the ship from coming into contact with ice may be adopted instead of this type of methodology.²

¹ The following information should be included in section 5.1 of the Certificate:
Limited to operation in Polar waters in accordance with the outcome of the accepted system for determining operational limitations appropriate to the ice strengthening applied.
Name of system:.....e.g. AIRSS, POLARIS, Ice Certificate
Reference document number:.....e.g. PWOM section number / Ice Certificate report number

² Where the ship is restricted to operate in ice-free waters as identified in 2.2 of the Certificate, the following information should be included in section 5.1 of the certificate: "Limited to ice free waters."

APPENDIX

METHODOLOGY FOR ASSESSING OPERATIONAL CAPABILITIES AND LIMITATIONS IN ICE: POLAR OPERATIONAL LIMIT ASSESSMENT RISK INDEXING SYSTEM (POLARIS)

Introduction

I The Polar Operational Limit Assessment Risk Indexing System (POLARIS) has been developed incorporating experience and best practices from Canada's Arctic Ice Regime Shipping System, the Russian Ice Certificate supplemented by pilot ice assistance as prescribed in the Rules of Navigation on the water area of the Northern Sea Route and other methodologies.

II The basis of POLARIS is an evaluation of the risks posed to the ship by ice conditions in relation to the ship's assigned ice class. It uses the WMO nomenclature and the ice class consistent with the ice class(es) referenced in the Polar Ship Certificate.

III POLARIS uses a Risk Index of Risk Values (RIVs) which are assigned to a ship based on the ice class. The RIVs may be used to evaluate the limitations of the ship operating in an ice regime using input either from historic or current ice charts for voyage planning or in real time from the bridge of the ship.

IV The principal features of POLARIS are:

- .1 the use of a combination of IACS Polar Class ice classes and ice classes assigned equivalence to Finnish-Swedish Ice Class Rules under HELCOM³, which are consistent with ice class references used elsewhere in the Code;
- .2 the use of ice type definitions generally consistent with WMO nomenclature and which can be found on international ice charts;
- .3 consideration of different ice regimes (e.g. waters with partial ice concentrations of different ice types and development stages and ice free waters);
- .4 consideration of ice decay – the outcome of which is a reduced risk due to a reduction in ice strength for some ice types when operating in warmer ambient temperatures; and
- .5 an acknowledgement that ships operating under icebreaker escort have a different risk profile to ships operating independently.

³ Refer to the annex to HELCOM Recommendation 25/7, Safety of Winter Navigation in the Baltic Sea Area, available at www.helcom.fi

1 Polar Operational Limit Assessment Risk Indexing System (POLARIS)

1.1 Risk Index Values

1.1.1 Ships assigned an ice class and ships without an ice class have been assigned a Risk Index in POLARIS. The Risk Index Values (RIVs) within the Risk Index are values corresponding to a relative risk evaluation for corresponding ice types.

1.1.2 Ice types in POLARIS generally conform to WMO nomenclature used on ice charts with the exception that Medium First Year Ice and Multi Year Ice are given two RIVs. Where the operator can confidently determine that the Medium First Year Ice in a regime is less than 1 metre in thickness, the RIVs in the column "Medium First Year Ice less than 1 m thick" may be used. Otherwise the RIVs in the column "Medium First Year Ice" should be used. Similarly, where the operator can confidently determine that the Multi-Year Ice in a regime is less than 2.5 metres in thickness, the RIVs in the column "Light Multi-Year Ice" may be used. Otherwise the RIVs in the column "Heavy Multi-Year Ice" should be used.

1.1.3 Risk Index values have been developed in tables 1.3 and 1.4. Table 1.4 reflects a reduction in risk associated with decayed ice during times of higher ambient temperatures for certain ice types. The standard Risk Index Values of table 1.3 should be used unless ice decay is confirmed by ice information/visual observation by personnel on board qualified in accordance with chapter 12 of the Polar Code. Only then may table 1.4 be used.

1.2 Risk Index Outcome

1.2.1 POLARIS uses a Risk Index Outcome (RIO) value to assess limitations for operation in ice. Risk Index Values (RIVs) are assigned to the ship based on ice class and ice types present according to tables 1.3 and 1.4. For each ice regime encountered, the Risk Index Values are used to determine a RIO that forms the basis of the decision to operate or the limitation of operations.

1.2.2 The RIO is determined by a summation of the RIVs for each ice type present in the ice regime multiplied by its concentration (expressed in tenths):

$$\text{RIO} = (C_1 \times \text{RIV}_1) + (C_2 \times \text{RIV}_2) + (C_3 \times \text{RIV}_3) + \dots (C_n \times \text{RIV}_n)$$

Where $C_1 \dots C_n$ are the concentrations (in tenths) of ice types within the ice regime; and

$\text{RIV}_1 \dots \text{RIV}_n$ are the corresponding Risk Index Values for each ice type.

1.3 Evaluation of the Risk Index Outcome for independent operations

1.3.1 Operational limitations for ships operating independently are determined based on the criteria in table 1.1, using the calculated value of the RIO for the ice regime encountered by the ship, given that due caution of the Mariner will be exercised, taking into account such factors as changes in weather and visibility.

1.3.2 POLARIS addresses three levels of operation, normal operation, elevated operational risk and operation subject to special consideration. For the purpose of POLARIS the RIO values in table 1.1 equal these three levels of operation.

Table 1.1: Risk Index Outcome criteria

<i>RIO_{SHIP}</i>	<i>Ice classes PC1-PC7</i>	<i>Ice classes below PC 7 and ships not assigned an ice class</i>
RIO ≥ 0	Normal operation	Normal operation
-10 ≤ RIO < 0	Elevated operational risk*	Operation subject to special consideration**
RIO < -10	Operation subject to special consideration**	Operation subject to special consideration**

* See section 1.4

** See section 1.5

1.4 Elevated Operational Risk

1.4.1 Ships operating in an elevated risk ice regime, based on the RIO outcome, should limit the speed to the values indicated in table 1.2. Operational measures may also include, provision of additional watch keeping or use of icebreaker support. When the speed reduction may impair the ship manoeuvrability, the operation should be avoided.

Table 1.2 Recommended speed limits for elevated risk operations

Ice Class	Recommended Speed Limit
PC1	11 knots
PC2	8 knots
PC3-PC5	5 knots
Below PC5	3 knots

1.4.2 Ships equipped with ice load measurement and monitoring systems can utilize these systems to calibrate recommended speeds included in table 1.2.

1.4.3 Ships having undergone full scale ice trials and/or calculation-based methodologies can utilize these results to calibrate recommended speeds included in table 1.2.

1.4.4 Recommended speed limits for elevated operational risk conditions should be included in the Polar Water Operational Manual (PWOM).

1.4.5 For voyage planning generally, areas in which the potential to encounter elevated risk operations has been identified should be avoided. Where elevated risk operations are identified and included in a voyage plan, contingency plans should be in place and documented in the PWOM.

1.5 Operations Subject to Special Consideration

1.5.1 Operations Subject to Special Consideration mean operations whereby extreme caution should be exercised by the Master and officers in charge of a navigational watch when navigating in ice.

1.5.2 Where a ship encounters an ice regime where the RIO identifies Operations Subject to Special Consideration, suitable procedures should be contained in the PWOM and should be followed. Such procedures should contain guidance to the operator on reducing the increased risks present to the ship and should include course alteration/re-routing, further reduction in speed and other special measures.

1.5.3 For voyage planning purposes, ice regimes where the RIO identifies Operations Subject to Special Consideration should be avoided.

1.6 Risk Index Outcome for ships under icebreaker escort

1.6.1 In determining the RIO for a ship under icebreaker escort, the ice immediately ahead of the ship should be considered as its ice regime. This regime should include both the track of the icebreaker and, when the icebreaker has a smaller beam than the escorted ship, any unmodified ice out to the maximum beam of the escorted ship.

1.6.2 The icebreaker itself should calculate its own RIO along the intended route.

1.6.3 In general, escorted operations should be reconsidered if the icebreaker encounters a RIO below 0 or if the escorted ship is in an ice regime for which operation is subject to special consideration.

1.6.4 For voyage planning purposes when icebreaker escort is intended to be used, the RIO derived from non-escorted historical ice data may be assumed to be modified by adding 10 to its calculated value. However, it is cautioned that this is an average value which can vary significantly. For actual operations, the RIO under escort should not be modified and should be derived as described in the previous paragraphs.

1.7 Operations in ice regimes containing glacial ice

1.7.1 The presence of glacial ice represents additional risks to the ship. Areas containing glacial ice should be approached with caution.

1.7.2 Appropriate training should be provided to the Master and officers in charge of a navigational watch when navigating in ice on identification and avoidance of glacial ice and the consequences of collision. Measures to avoid glacial ice should be documented in the PWOM.

1.7.3 Where glacial ice is encountered, in addition to the RIO, a safe stand-off distance should be observed by the ship. This stand-off distance should be recorded in the PWOM.

Table 1.3 Risk Index Values

Ice Class	Ice-Free	New Ice	Grey Ice	Grey White Ice	Thin First Year Ice 1st Stage	Thin First Year Ice 2nd Stage	Medium First Year Ice less than 1 m thick	Medium First Year Ice	Thick First Year Ice	Second Year Ice	Light Multi Year Ice, less than 2.5 m thick	Heavy Multi Year Ice
PC1	3	3	3	3	2	2	2	2	2	2	1	1
PC2	3	3	3	3	2	2	2	2	2	1	1	0
PC3	3	3	3	3	2	2	2	2	2	1	0	-1
PC4	3	3	3	3	2	2	2	2	1	0	-1	-2
PC5	3	3	3	3	2	2	1	1	0	-1	-2	-2
PC6	3	2	2	2	2	1	1	0	-1	-2	-3	-3
PC7	3	2	2	2	1	1	0	-1	-2	-3	-3	-3
IA Super	3	2	2	2	2	1	0	-1	-2	-3	-4	-4
IA	3	2	2	2	1	0	-1	-2	-3	-4	-5	-5
IB	3	2	2	1	0	-1	-2	-3	-4	-5	-6	-6
IC	3	2	1	0	-1	-2	-3	-4	-5	-6	-7	-8
Not Ice Strengthened	3	1	0	-1	-2	-3	-4	-5	-6	-7	-8	-8

Table 1.4 Risk Index Values – decayed ice conditions

Ice Class	Ice-Free	New Ice	Grey Ice	Grey White Ice	Thin First Year ice 1 st Stage	Thin First Year Ice 2 nd Stage	Medium First Year Ice, less than 1 m thick	Medium First Year Ice	Thick First Year Ice	Second Year Ice	Light Multi Year Ice, less than 2.5 m thick	Heavy Multi Year Ice
PC1	3	3	3	3	2	2	2	2	2	2	1	1
PC2	3	3	3	3	2	2	2	2	2	1	1	0
PC3	3	3	3	3	2	2	2	2	2	1	0	-1
PC4	3	3	3	3	2	2	2	2	1	0	-1	-2
PC5	3	3	3	3	2	2	2	2	1	-1	-2	-2
PC6	3	2	2	2	2	1	2	1	0	-2	-3	-3
PC7	3	2	2	2	1	1	1	0	-1	-3	-3	-3
IA Super	3	2	2	2	2	1	1	0	-1	-3	-4	-4
IA	3	2	2	2	1	0	0	-1	-2	-4	-5	-5
IB	3	2	2	1	0	-1	-1	-2	-3	-5	-6	-6
IC	3	2	1	0	-1	-2	-2	-3	-4	-6	-7	-8
Not Ice Strengthened	3	1	0	-1	-2	-3	-3	-4	-5	-7	-8	-8

4 ALBERT EMBANKMENT
LONDON SE1 7SR
Telephone: +44 (0)20 7735 7611 Fax: +44 (0)20 7587 3210

MSC.1/Circ.1526
1 June 2016

INTERIM GUIDELINES ON MARITIME CYBER RISK MANAGEMENT

- 1 The Maritime Safety Committee, at its ninety-sixth session (11 to 20 May 2016), having considered the urgent need to raise awareness on cyber risk threats and vulnerabilities, approved the *Interim guidelines on maritime cyber risk management*, as set out in the annex.
- 2 The Guidelines provide high-level recommendations on maritime cyber risk management to safeguard shipping from current and emerging cyberthreats and vulnerabilities. The Guidelines also include functional elements that support effective cyber risk management.
- 3 Member Governments are invited to bring the contents of this circular to the attention of all stakeholders concerned.

ANNEX

INTERIM GUIDELINES ON MARITIME CYBER RISK MANAGEMENT

1 INTRODUCTION

1.1 These Guidelines provide high-level recommendations for maritime cyber risk management. For the purpose of these Guidelines, *maritime cyber risk* refers to a measure of the extent to which a technology asset is threatened by a potential circumstance or event, which may result in shipping-related operational, safety or security failures as a consequence of information or systems being corrupted, lost or compromised.

1.2 Stakeholders should take the necessary steps to safeguard shipping from current and emerging threats and vulnerabilities related to digitization, integration and automation of processes and systems in shipping.

1.3 For details and guidance related to the development and implementation of specific risk management processes, users of these guidelines should refer to specific Member Governments' and Flag Administrations' requirements, as well as relevant international and industry standards and best practices.

1.4 Risk management is fundamental to safe and secure shipping operations. Risk management has traditionally been focused on operations in the physical domain, but greater reliance on digitization, integration, automation and network-based systems has created an increasing need for cyber risk management in the shipping industry.

1.5 Predicated on the goal of supporting safe and secure shipping, which is operationally resilient to cyber risks, these Guidelines provide recommendations that can be incorporated into existing risk management processes. In this regard, the Guidelines are complementary to the safety and security management practices established by this Organization.

2 GENERAL

2.1 Background

2.1.1 Cybertechnologies have become essential to the operation and management of numerous systems critical to the safety and security of shipping and protection of the marine environment. In some cases, these systems are to comply with international standards and Flag Administration requirements. However, the vulnerabilities created by accessing, interconnecting or networking these systems can lead to cyber risks which should be addressed. Vulnerable systems could include, but are not limited to:

- Bridge systems;
- Cargo handling and management systems;
- Propulsion and machinery management and power control systems;
- Access control systems;
- Passenger servicing and management systems;
- Passenger facing public networks;
- Administrative and crew welfare systems; and
- Communication systems.

2.1.2 The distinction between information technology and operational technology systems should be considered. Information technology systems may be thought of as focusing on the use of data as information. Operational technology systems may be thought of as focusing on the use of data to control or monitor physical processes. Furthermore, the protection of information and data exchange within these systems should also be considered.

2.1.3 While these technologies and systems provide significant efficiency gains for the maritime industry, they also present risks to critical systems and processes linked to the operation of systems integral to shipping. These risks may result from vulnerabilities arising from inadequate operation, integration, maintenance and design of cyber-related systems, and from intentional and unintentional cyberthreats.

2.1.4 Threats are presented by malicious actions (e.g. hacking or introduction of malware) or the unintended consequences of benign actions (e.g. software maintenance or user permissions). In general, these actions expose vulnerabilities (e.g. outdated software or ineffective firewalls) or exploit a vulnerability in operational or information technology. Effective cyber risk management should consider both kinds of threat.

2.1.5 Vulnerabilities can result from inadequacies in design, integration and/or maintenance of systems, as well as lapses in cyberdiscipline. In general, where vulnerabilities in operational and/or information technology are exposed or exploited, either directly (e.g. weak passwords leading to unauthorized access) or indirectly (e.g. the absence of network segregation), there can be implications for security and the confidentiality, integrity and availability of information. Additionally, when operational and/or information technology vulnerabilities are exposed or exploited, there can be implications for safety, particularly where critical systems (e.g. bridge navigation or main propulsion systems) are compromised.

2.1.6 Effective cyber risk management should also consider safety and security impacts resulting from the exposure or exploitation of vulnerabilities in information technology systems. This could result from inappropriate connection to operational technology systems or from procedural lapses by operational personnel or third parties, which may compromise these systems (e.g. inappropriate use of removable media such as a memory stick).

2.1.7 Further information regarding vulnerabilities and threats can be found in the additional guidance and standards referenced in section 4.

2.1.8 These rapidly changing technologies and threats make it difficult to address these risks only through technical standards. As such, these Guidelines recommend a risk management approach to cyber risks that is resilient and evolves as a natural extension of existing safety and security management practices.

2.1.9 In considering potential sources of threats and vulnerabilities and associated risk mitigation strategies, a number of potential control options for cyber risk management should also be taken into consideration, including amongst others management, operational or procedural, and technical controls.

2.2 Application

2.2.1 These Guidelines are primarily intended for all organizations in the shipping industry, and are designed to encourage safety and security management practices in the cyberdomain.

2.2.2 Recognizing that no two organizations in the shipping industry are the same, these Guidelines are expressed in broad terms in order to have a widespread application. Ships with limited cyber-related systems may find a simple application of these Guidelines to be sufficient; however, ships with complex cyber-related systems may require a greater level of care and should seek additional resources through reputable industry and Government partners.

2.2.3 These Guidelines are recommendatory.

3 ELEMENTS OF CYBER RISK MANAGEMENT

3.1 For the purpose of these Guidelines, *cyber risk management* means the process of identifying, analysing, assessing, and communicating a cyber-related risk and accepting, avoiding, transferring, or mitigating it to an acceptable level, considering costs and benefits of actions taken to stakeholders.

3.2 The goal of maritime cyber risk management is to support safe and secure shipping, which is operationally resilient to cyber risks.

3.3 Effective cyber risk management should start at the senior management level. Senior management should embed a culture of cyber risk awareness into all levels of an organization and ensure a holistic and flexible cyber risk management regime that is in continuous operation and constantly evaluated through effective feedback mechanisms.

3.4 One accepted approach to achieve the above is to comprehensively assess and compare an organization's current, and desired, cyber risk management postures. Such a comparison may reveal gaps that can be addressed to achieve risk management objectives through a prioritized cyber risk management plan. This risk-based approach will enable an organization to best apply its resources in the most effective manner.

3.5 These Guidelines present the functional elements that support effective cyber risk management. These functional elements are not sequential – all should be concurrent and continuous in practice and should be incorporated appropriately in a risk management framework:

- .1 Identify: Define personnel roles and responsibilities for cyber risk management and identify the systems, assets, data and capabilities that, when disrupted, pose risks to ship operations.
- .2 Protect: Implement risk control processes and measures, and contingency planning to protect against a cyberevent and ensure continuity of shipping operations.
- .3 Detect: Develop and implement activities necessary to detect a cyber event in a timely manner.
- .4 Respond: Develop and implement activities and plans to provide resilience and to restore systems necessary for shipping operations or services impaired due to a cyberevent.
- .5 Recover: Identify measures to back-up and restore cyber systems necessary for shipping operations impacted by a cyberevent.

3.6 These functional elements encompass the activities and desired outcomes of effective cyber risk management across critical systems affecting maritime operations and information exchange, and constitute an ongoing process with effective feedback mechanisms.

3.7 Effective cyber risk management should ensure an appropriate level of awareness of cyber risks at all levels of an organization. The level of awareness and preparedness should be appropriate to roles and responsibilities in the cyber risk management system.

4 BEST PRACTICES FOR IMPLEMENTATION OF CYBER RISK MANAGEMENT

4.1 The approach to cyber risk management described herein provides a foundation for better understanding and managing cyber risks, thus enabling a risk management approach to address cyberthreats and vulnerabilities. For detailed guidance on cyber risk management, users of these guidelines should also refer to Member Governments' and Flag Administrations' requirements, as well as relevant international and industry standards and best practices.

4.2 Additional guidance and standards may include, but are not limited to:¹

- The Guidelines on Cyber Security on board Ships by BIMCO, CLIA, ICS, INTERCARGO and INTERTANKO.
- ISO/IEC 27001 standard on Information technology – Security techniques – Information security management systems – Requirements. Published jointly by the International Organization for Standardization (ISO) and the International Electrotechnical Commission (IEC).
- United States National Institute of Standards and Technology's Framework for Improving Critical Infrastructure Security (the NIST Framework).

4.3 Reference should be made to the most current version of any guidance or standards utilized.

¹ The additional guidance and standards are listed as a non-exhaustive reference to further detailed information for users of these Guidelines. The referenced guidance and standards have not been issued by the Organization and their use remains at the discretion of individual users of these Guidelines.

4 ALBERT EMBANKMENT
LONDON SE1 7SR
Telephone: +44 (0)20 7735 7611 Fax: +44 (0)20 7587 3210

MSC.1/Circ.1527
6 June 2016

UNIFIED INTERPRETATIONS OF SOLAS CHAPTER II-2

1 The Maritime Safety Committee, at its ninety-sixth session (11 to 20 May 2016), with a view to providing more specific guidance on the conditions under which materials other than steel may be permitted for components mounted on engines, turbines and gearboxes; arrangements for fixed hydrocarbon gas detection systems in double-hull and double-bottom spaces of oil tankers; and non-combustible material as "steel or equivalent" for ventilation ducts, approved unified interpretations of SOLAS chapter II-2, prepared by the Sub-Committee on Ship Systems and Equipment, at its second session (23 to 27 March 2015), as set out in the annex.

2 Member States are invited to use the annexed unified interpretations as guidance when applying SOLAS regulations II-2/4 and II-2/9 and to bring the unified interpretations to the attention of all parties concerned.

ANNEX

UNIFIED INTERPRETATIONS OF SOLAS CHAPTER II-2

SOLAS REGULATION II-2/4

Application of materials other than steel on engine, turbine and gearbox installations

Materials other than steel may be assessed in relation to the risk of fire associated with the component and its installation. The use of materials other than steel is considered acceptable for the following applications:

- .1 internal pipes which cannot cause any release of flammable fluid onto the machinery or into the machinery space in case of failure; or
- .2 components that are only subject to liquid spray on the inside when the machinery is running, such as machinery covers, rocker box covers, camshaft end covers, inspection plates and sump tanks. It is a condition that the pressure inside these components and all the elements contained therein is less than 0.18 N/mm² and that wet sumps have a volume not exceeding 100 litres; or
- .3 components attached to machinery which satisfy fire test criteria according to standard ISO 19921:2005/19922:2005 or other standards acceptable to the Administration, and which retain mechanical properties adequate for the intended installation.

SOLAS REGULATION II-2/4.5.7.3.1

Arrangements for fixed hydrocarbon gas detection systems in double-hull and double-bottom spaces of oil tankers

- 1 The term "cargo tanks" in the phrase "spaces adjacent to the cargo tanks" includes slop tanks except those arranged for the storage of oily water only.
- 2 The term "spaces" in the phrase "spaces under the bulkhead deck adjacent to cargo tanks" includes dry compartments such as ballast pump-rooms and bow thruster rooms and any tanks such as freshwater tanks, but excludes fuel oil tanks.
- 3 The term "adjacent" in the phrase "adjacent to the cargo tanks" includes ballast tanks, void spaces, other tanks or compartments located below the bulkhead deck located adjacent to cargo tanks and includes any spaces or tanks located below the bulkhead deck which form a cruciform (corner to corner) contact with the cargo tanks.

SOLAS REGULATION II-2/9.7.1.1

Non-combustible material as "steel or equivalent" for ventilation ducts

With respect to SOLAS regulation II-2/9.7.1.1, a ventilation duct made of material other than steel may be considered equivalent to a ventilation duct made of steel, provided the material is non-combustible and has passed a standard fire test in accordance with annex 1 to part 3 of the 2010 FTP Code as a non-load bearing structure for 30 minutes, following the requirements for testing "B" class divisions.

4 ALBERT EMBANKMENT
LONDON SE1 7SR
Telephone: +44 (0)20 7735 7611 Fax: +44 (0)20 7587 3210

MSC.1/Circ.1528
6 June 2016

UNIFIED INTERPRETATIONS OF CHAPTERS 5, 6 AND 9 OF THE FSS CODE

1 The Maritime Safety Committee, at its ninety-sixth session (11 to 20 May 2016), with a view to providing more specific guidance on fixed gas fire-extinguishing systems and fixed fire detection and fire alarm systems; foam-generating capacity of fixed foam fire-extinguishing systems; and an additional indicating unit in the cargo control rooms, approved unified interpretations of chapters 5, 6 and 9 of the FSS Code, prepared by the Sub-Committee on Ship Systems and Equipment, at its second session (23 to 27 March 2015), as set out in the annex.

2 Member States are invited to use the annexed unified interpretations as guidance when applying paragraph 2.2.1.7 of chapter 5 of the FSS Code, paragraphs 3.2.1.2 and 3.3.1.2 of chapter 6 of the FSS Code, as amended by resolution MSC.327(90), and paragraph 2.5.1.3 of chapter 9, of the FSS Code, as amended by resolution MSC.339(91), to the systems and units to be installed on board ships constructed on or after 13 May 2016 and to bring the unified interpretations to the attention of all parties concerned.

ANNEX

UNIFIED INTERPRETATIONS OF CHAPTERS 5, 6 AND 9 OF THE FSS CODE

CHAPTER 5 – FIXED GAS FIRE-EXTINGUISHING SYSTEMS

Fixed gas fire-extinguishing systems (paragraph 2.2.1.7)

1 The "quantity of gas" means that quantity required for the largest cargo space in accordance with the provisions of paragraph 2.1.1.1 of chapter 5:

"2.1.1.1 Where the quantity of the fire-extinguishing medium is required to protect more than one space, the quantity of medium available need not be more than the largest quantity required for any one space so protected. ... Adjacent spaces with independent ventilation systems not separated by at least A-0 class divisions should be considered as the same space."

2 In such cases, the system controls should be capable of allowing one third, two thirds or the entire quantity of gas as required by paragraph 2.1.1.1 of chapter 5 to be discharged to comply with the last sentence of paragraph 2.2.1.7 (i.e. the number of setting points of control is three).

CHAPTER 6 – FIXED FOAM FIRE-EXTINGUISHING SYSTEMS

Foam-generating capacity of fixed foam fire-extinguishing systems (paragraphs 3.2.1.2 and 3.3.1.2, as amended by resolution MSC.327(90))

1 This interpretation of the term "largest protected space" applies to a machinery space of category A protected by a fixed high-expansion foam fire-extinguishing system complying with the provisions of the FSS Code.

2 Where such a machinery space includes a casing (e.g. an engine casing in a machinery space of category A containing internal combustion machinery, and/or a boiler), the volume of such a casing, above the level up to which foam should be filled to protect the highest position of the fire risk objects within the machinery space, need not be included in the volume of the protected space (see figure 1).

3 The level up to which foam should be filled to protect the highest positioned fire risk objects within the machinery space should not be less than:

- 1 m above the highest point of any such object; or
- the lowest part of the casing,

whichever is higher (see figure 1).

4 Where such a machinery space does not include a casing, the volume of the largest protected space should be that of the space in its entirety, irrespective of the location of any fire risk object therein (see figure 2).

5 Fire risk objects include, but may not be limited to, those listed in SOLAS regulation II-2/3.31 and those defined in regulation II-2/3.34. Although not referred to in those regulations, they may also include items having a similar fire risk such as exhaust gas boilers or oil fuel tanks.

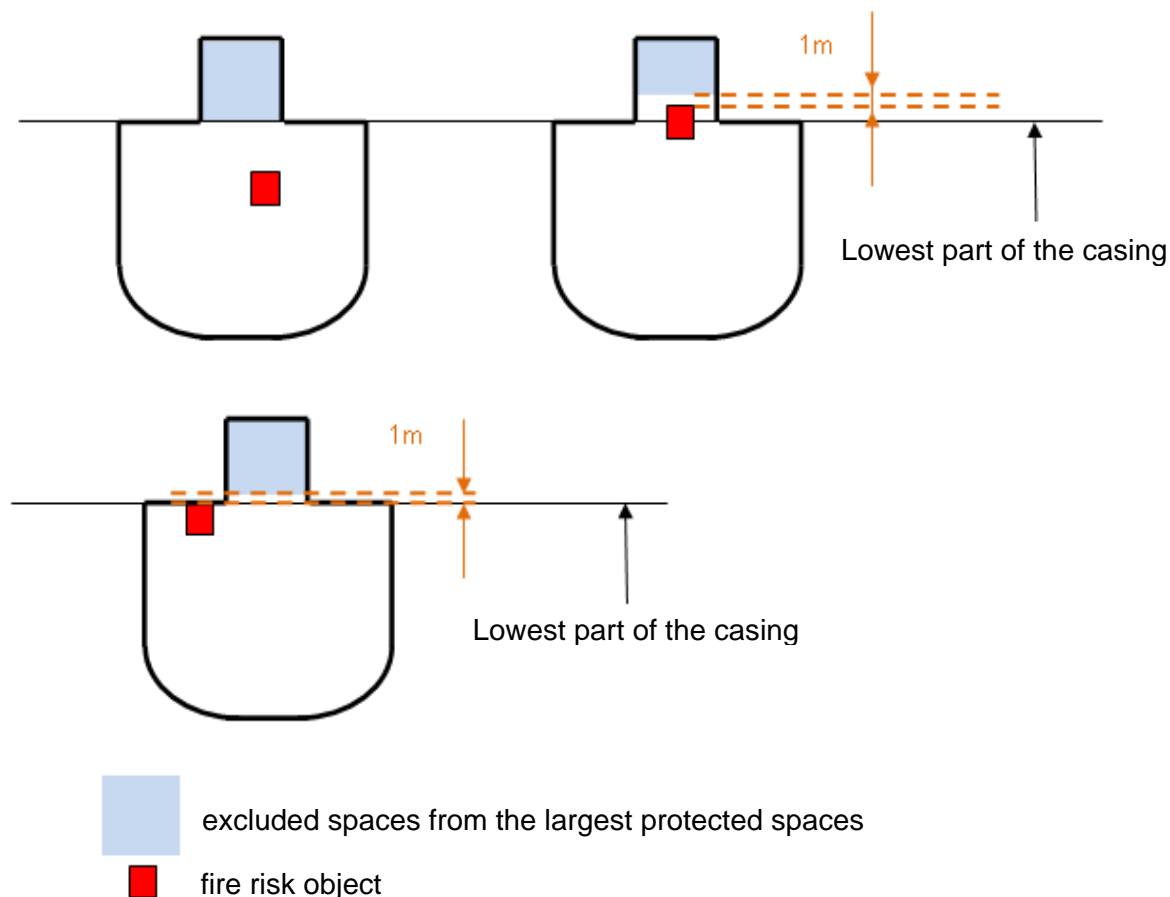

Figure 1: Machinery space including a casing

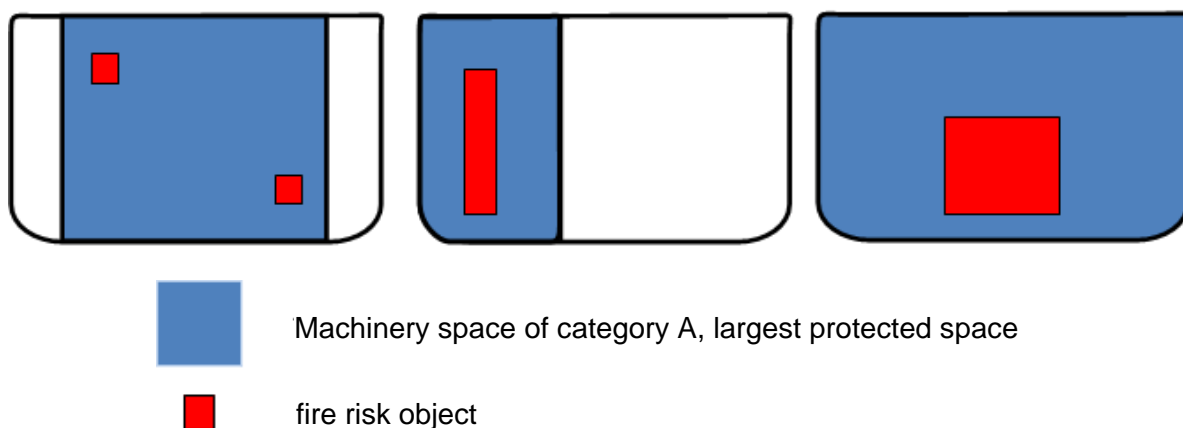

Figure 2: Machinery space not including a casing

CHAPTER 9 – FIXED FIRE DETECTION AND FIRE ALARM SYSTEM

Additional indicating unit in the cargo control room (paragraph 2.5.1.3, as amended by resolution MSC.339(91))

A space in which a cargo control console is installed, but does not serve as a dedicated cargo control room (e.g. ship's office, machinery control room), should be regarded as a cargo control room for the purposes of paragraph 2.5.1.3 of chapter 9 of the FSS Code, as amended by resolution MSC.339(91), and therefore be provided with an additional indicating unit.

4 ALBERT EMBANKMENT
LONDON SE1 7SR
Telephone: +44 (0)20 7735 7611 Fax: +44 (0)20 7587 3210

MSC.1/Circ.1529
6 June 2016

**UNIFIED INTERPRETATIONS OF PARAGRAPH 4.4.7.6 OF THE LSA CODE,
AS AMENDED BY RESOLUTION MSC.320(89)**

1 The Maritime Safety Committee, at its ninety-sixth session (11 to 20 May 2016), with a view to providing more specific guidance on lifeboat release and retrieval systems, approved unified interpretations of paragraph 4.4.7.6 of the LSA Code, as amended by resolution MSC.320(89), prepared by the Sub-Committee on Ship Systems and Equipment, at its second session (23 to 27 March 2015), as set out in the annex.

2 Member States are invited to use the annexed unified interpretation as guidance when applying paragraphs 4.4.7.6.6, 4.4.7.6.7.2, 4.4.7.6.9 and 4.4.7.6.14 of the LSA Code, as amended by resolution MSC.320(89), to the systems to be installed on board ships constructed on or after 13 May 2016 and to bring the unified interpretations to the attention of all parties concerned.

ANNEX

UNIFIED INTERPRETATIONS OF PARAGRAPH 4.4.7.6 OF THE LSA CODE, AS AMENDED BY RESOLUTION MSC.320(89)

IMPLEMENTATION OF THE REQUIREMENTS RELATING TO LIFEBOAT RELEASE AND RETRIEVAL SYSTEMS

Paragraphs 4.4.7.6.6 and 4.4.7.6.7.2

1 The reset function as required by paragraph 4.4.7.6.6 should also apply to the "other means" or "similar device" referred to in paragraph 4.4.7.6.7.2.

2 Where a safety pin is fitted to facilitate compliance with SOLAS regulation III/1.5 then, in line with paragraph 4 of the annex to MSC.1/Circ.1327, the safety pin arrangement should be acceptable to the hook manufacturer, as defined in paragraph 9.9 of the annex to MSC.1/Circ.1392.

Paragraph 4.4.7.6.9

1 All interlocks ("mechanical protection" of on-load release), which include hydrostatic components in the operating mechanism, should also be of material corrosion resistant in the marine environment.

2 Where stainless steel having a Pitting Resistance Equivalent Number (PREN)¹ of 22 or more is chosen, such stainless steel does not need to be subjected to standard ISO 9227:2012 or other equivalent recognized national standard.

3 Where stainless steel having a PREN < 22, or another corrosion resistant material/alloy is chosen, the material should be qualified by corrosion test according to standard ISO 9227:2012 or other equivalent recognized national standard. When the test is carried out in accordance with standard ISO 9227:2012, neutral salt spray (NSS) should be used, with 1,000 hours test duration for components outside the lifeboat, and 160 hours for those inside the lifeboat. The salt spray tests may be conducted by using round specimens (diameter is 14 mm) according to IACS UR W2.4.2.

4 After the salt spray test, the release mechanism should be subjected to load and release test as described in resolution MSC.81(70), as amended by resolution MSC.321(89), part 1, paragraph 6.9.4.1, to demonstrate satisfactory operation. The load and release should be repeated 10 times. Where specimens are used for the salt spray tests, tensile tests should be conducted in lieu of the load and release test. The results from the tests should be in order to verify that the reduction in the ultimate tensile strength and reduction in cross sectional area ratio is less than 5% between corrosion tested and non-corrosion tested specimens.

5 Where austenitic stainless steels (e.g. 316L or 316) are used for welded structures, the risk of sensitization to intergranular corrosion should be addressed by the component manufacturer's quality control system.

¹ PREN = 1 • %Cr + 3.3 (%Mo + 0.5 • %W) + 16 • %N

6 Austenitic stainless steels 201, 304, 321, 347 are susceptible to pitting and crevice corrosion and, therefore, unsuitable for these applications. For operating cables covered with sheath and installed inside the lifeboat, inner cables made of austenitic stainless steels 304 are acceptable without the corrosion test above.

Paragraph 4.4.7.6.14

The hanging-off arrangement, including the connections to the lifeboat release and retrieval system and davit, should be designed with a calculated factor of safety of 6 based on the ultimate strength of the materials used, and mass of the lifeboat when loaded with its full complement of fuel and equipment plus 1,000 kg equally distributed between the falls.

4 ALBERT EMBANKMENT
LONDON SE1 7SR
Telephone: +44 (0)20 7735 7611 Fax: +44 (0)20 7587 3210

MSC.1/Circ.1530
6 June 2016

**UNIFIED INTERPRETATIONS OF SOLAS REGULATIONS III/6.4 AND III/6.5
AND SECTION 7.2 OF THE LSA CODE**

1 The Maritime Safety Committee, at its ninety-sixth session (11 to 20 May 2016), with a view to providing more specific guidance on general emergency alarms and public address systems in ro-ro spaces, approved unified interpretations of SOLAS regulations III/6.4 and III/6.5 and section 7.2 of the LSA Code, prepared by the Sub-Committee on Ship Systems and Equipment, at its second session (23 to 27 March 2015), as set out in the annex.

2 Member States are invited to use the annexed unified interpretations as guidance when applying SOLAS regulations III/6.4 and III/6.5 and section 7.2 of the LSA Code and to bring the unified interpretations to the attention of all parties concerned.

ANNEX

UNIFIED INTERPRETATIONS OF SOLAS REGULATIONS III/6.4 AND III/6.5 AND SECTION 7.2 OF THE LSA CODE

General

1 The term "accommodation" defined in SOLAS regulation II-2/3.1 applies also to SOLAS regulation III/6.4.3.

2 The term "similar spaces" used in SOLAS regulation II-2/3.1, when applied to public address and general alarm systems required in SOLAS regulations II-2/12.3, III/6.4 and III/6.5, includes, but is not limited to, the following spaces: stairways, lifts, recreation rooms and pantries.

3 The word "audibility" or the term "audible" used in SOLAS regulations III/6.4.2, III/6.4.3 and III/6.5, and when referred to in these unified interpretations, means the sound pressure level requirements as defined in section 7.2 of the LSA Code.

General emergency alarm

4 Regarding the audibility (sound pressure) requirements in SOLAS regulations III/6.4.2 and III/6.4.3 and section 7.2 of the LSA Code, the audibility (sound pressure) requirements as defined in section 7.2 of the LSA Code, should include special category spaces, ro-ro spaces and vehicle spaces as defined in SOLAS regulations II-2/3.46, II-2/3.41 and II-2/3.49 on all types of ship that carry vehicles (for example PCC/PCTC/RO PAX vessel).

5 For cargo ships, it is not necessary to provide a public address system in cargo spaces used for the carriage of vehicles (i.e. only a general emergency alarm is required in spaces used for the carriage of vehicles on cargo ships).

6 Regarding SOLAS regulation III/6.4.3, the term "normal crew working spaces" includes spaces where routine maintenance tasks or local control of machinery operated at sea are undertaken.

Public address system

7 Regarding the audibility (sound pressure) requirements in SOLAS regulation III/6.5.2 for passenger ships, the audibility (sound pressure) requirements should include special category spaces, ro-ro spaces and vehicle spaces as defined in SOLAS regulations II-2/3.41, II-2/3.46 and II-2/3.49 on board passenger ships, if accessible by the general public at sea.

8 For cargo ships, it is not necessary to provide a public address system in cargo spaces used for the carriage of vehicles (i.e. only a general emergency alarm is required in spaces used for the carriage of vehicles on cargo ships).

9 Regarding SOLAS regulation III/6.5.2 and the requirements of paragraph 7.2.2.1 of the LSA Code, the term "spaces where crew members or passengers or both are normally present" includes all accommodation spaces. With respect to spaces where a public address system may not be required in accordance with paragraph 7.2.2.1 of the LSA Code, these may be spaces such as under deck passageways, including passageways in the car hold between an accommodation space and an engine-room, bosun's lockers and pump-rooms.

10 With respect to cabin/state rooms, the sound pressure levels as stated in paragraph 7.2.2.2.1 of the LSA Code should be attained as required inside the cabin/state room, during sea trials.

11 Where an individual loudspeaker has a device for local silencing, an override arrangement from the control station(s), including the navigating bridge, should be in place.

4 ALBERT EMBANKMENT
LONDON SE1 7SR
Telephone: +44 (0)20 7735 7611 Fax: +44 (0)20 7587 3210

MSC.1/Circ.1533
6 June 2016

REVISED GUIDELINES ON EVACUATION ANALYSIS FOR NEW AND EXISTING PASSENGER SHIPS

1 The Maritime Safety Committee, at its seventy-first session (19 to 28 May 1999), having approved the *Interim guidelines for a simplified evacuation analysis of ro-ro passenger ships* (MSC/Circ.909) as a guide for the implementation of SOLAS regulation II-2/28-1.3, requested the Sub-Committee on Fire Protection (FP) to also develop guidelines on evacuation analysis for passenger ships in general and high-speed passenger craft.

2 The Committee, at its seventy-fourth session (30 May to 8 June 2001), following a recommendation of the forty-fifth session of the FP Sub-Committee (8 to 12 January 2001), approved the *Interim guidelines for a simplified evacuation analysis of high-speed passenger craft* (MSC/Circ.1001). The Committee, at its eightieth session (11 to 20 May 2005), after having considered a proposal by the forty-ninth session of the FP Sub-Committee (24 to 28 January 2005) in light of the experience gained in the application of the aforementioned interim guidelines, approved the *Guidelines for a simplified evacuation analysis of high-speed passenger craft* (MSC/Circ.1166), which superseded MSC/Circ.1001, together with the worked example appended thereto.

3 The Committee, at its seventy-fifth session (15 to 24 May 2002), further approved the *Interim guidelines on evacuation analyses for new and existing passenger ships* (MSC/Circ.1033) and invited Member States to collect and submit to the FP Sub-Committee for further consideration, any information and data resulting from research and development activities, full-scale tests and findings on human behaviour which may be relevant for the necessary future upgrading of the interim guidelines.

4 The Committee, at its eighty-third session (3 to 12 October 2007), approved the *Guidelines on evacuation analyses for new and existing passenger ships* (MSC.1/Circ.1238), including ro-ro passenger ships.

5 The Committee, at its ninety-sixth session (11 to 20 May 2016), approved the *Revised Guidelines on evacuation analyses for new and existing passenger ships*, as set out in the annexes, as a guide for the implementation of amendments to SOLAS regulation II-2/13.3.2.7¹, making evacuation analysis mandatory not only for ro-ro passenger ships but also for other passenger ships constructed on or after 1 January 2020.

¹ The amendments to SOLAS regulation II-2/13.3.2.7 were adopted by the Committee, at its ninety-sixth session (11 to 20 May 2016) and are expected to enter into force on 1 January 2020.

6 The annexed revised guidelines offer the possibility of using two distinct methods:

- .1 a simplified evacuation analysis (annex 2); and/or
- .2 an advanced evacuation analysis (annex 3).

7 The assumptions inherent within the simplified method are by their nature limiting. As the complexity of the ships increases (through the mix of passenger types, accommodation types, number of decks and number of stairways), these assumptions become less representative of reality. In such cases, the use of the advanced method would be preferred. However, in early design iterations of the ship, the simplified method has merit due to its relative ease of use and its ability to provide an approximation to expected evacuation performance.

8 It is also to be noted that the acceptable evacuation durations in these guidelines are based on an analysis of fire risk.

9 Member States are invited to bring the annexed guidelines (annexes 1 to 3) to the attention of all those concerned and, in particular, to:

- .1 recommend them to use these guidelines when conducting evacuation analyses, early in the design process, on new ro-ro passenger ships in compliance with SOLAS regulation II-2/13.7.4 (which entered into force on 1 July 2002) and SOLAS regulation II-2/13.3.2.7 (which is expected to enter into force on 1 January 2020);
- .2 recommend them to use these guidelines when conducting evacuation analyses, early in the design process, on new passenger ships other than ro-ro passenger ships constructed on or after 1 January 2020 carrying more than 36 passengers in compliance with SOLAS regulation II-2/13.3.2.7 (which is expected to enter into force on 1 January 2020); and
- .3 encourage them to conduct evacuation analyses on existing passenger ships using these guidelines.

10 Member States are also encouraged to:

- .1 collect and submit to the Sub-Committee on Ship Systems and Equipment for further consideration, any information and data resulting from research and development activities, full-scale tests and findings on human behaviour, which may be relevant for the necessary future upgrading of the present guidelines;
- .2 submit to the Sub-Committee on Ship Systems and Equipment information on experience gained in the implementation of the guidelines; and
- .3 use the Guidance on validation/verification of evacuation simulation tools provided in annex 3 to the present circular when assessing the ability of evacuation simulation tools to perform an advanced evacuation analysis.

11 This circular supersedes MSC.1/Circ.1238.

ANNEX 1

REVISED GUIDELINES ON EVACUATION ANALYSIS FOR NEW AND EXISTING PASSENGER SHIPS

Preamble

1 The following information is provided for consideration by, and guidance to, the users of these guidelines:

- .1 To ensure uniformity of application, typical benchmark scenarios and relevant data are specified in the guidelines. Therefore, the aim of the analysis is to assess the performance of the ship with regard to the benchmark scenarios rather than simulating an actual emergency.
- .2 Although the approach is, from a theoretical and mathematical point of view, sufficiently developed to deal with realistic simulations of evacuation on board ships, there is still a shortfall in the amount of verification data and practical experience on its application. When suitable information is provided by Member Governments, the Organization should reappraise the figures, parameters, benchmark scenarios and performance standards defined in the interim guidelines.
- .3 Almost all the data and parameters given in the guidelines are based on well-documented data coming from civil building experience. The data and results from ongoing research and development show the importance of such data for improving the interim guidelines. Nevertheless, the simulation of these benchmark scenarios are expected to improve ship design by identifying inadequate escape arrangements, congestion points and optimizing evacuation arrangements, thereby significantly enhancing safety.

2 For the above considerations, it is recommended that:

- .1 the evacuation analysis be carried out as indicated in the guidelines, in particular using the scenarios and parameters provided;
- .2 the objective should be to assess the evacuation process through benchmark cases rather than trying to model the evacuation in real emergency conditions;
- .3 application of the guidelines to analyse actual events to the greatest extent possible, where passengers were called to assembly stations during a drill or where a passenger ship was actually evacuated under emergency conditions, would be beneficial in validating the guidelines;
- .4 the aim of the evacuation analysis for existing passenger ships should be to identify congestion points and/or critical areas and to provide recommendations as to where these points and critical areas are located on board; and
- .5 keeping in mind that it is the company's responsibility to ensure passenger and crew safety by means of operational measures, if the result of an analysis, conducted on an existing passenger ship shows that the maximum allowable evacuation duration has been exceeded, then the company should ensure that suitable operational measures (e.g. updates of the onboard emergency procedures, improved signage, emergency preparedness of the crew, etc.) are implemented.

1 General

The purpose of this part of the guidelines is to present the methodology for conducting an evacuation analysis and, in particular, to:

- .1 confirm that the performance standards set out in these guidelines can be met;
- .2 identify and eliminate, as far as practicable, congestion which may develop during an abandonment, due to normal movement of passengers and crew along escape routes, taking into account the possibility that crew may need to move along these routes in a direction opposite the movement of passengers;
- .3 demonstrate that escape arrangements are sufficiently flexible to provide for the possibility that certain escape routes, assembly stations, embarkation stations or survival craft may be unavailable as a result of a casualty;
- .4 identify areas of intense counter and cross flows; and
- .5 provide information gained by the evacuation analysis to the operators.

2 Definitions

2.1 *Persons load* is the number of persons considered in the means of escape calculations contained in chapter 13 of the *International Code for Fire Safety Systems (FSS Code)* (resolution MSC.98(73)).

2.2 *Response duration (R)* is the duration it takes for people to react to the situation. This duration begins upon initial notification (e.g. alarm) of an emergency and ends when the passenger has accepted the situation and begins to move towards an assembly station.

2.3 *Individual travel duration* is the duration incurred by an individual in moving from its starting location to reach the assembly station.

2.4 *Individual assembly duration* is the sum of the individual response and the individual travel duration.

2.5 *Total assembly duration (t_A)* is the maximum individual assembly duration.

2.6 *Total travel duration (T)* is the duration it takes for all persons on board to move from where they are upon notification to the assembly stations.

2.7 *Embarkation and launching duration (E+L)* is the duration required to provide for abandonment by the total number of persons on board, starting from the time the abandon ship signal is given after all persons have been assembled, with lifejackets donned.

3 Method of evaluation

The steps in the evacuation analysis are specified as below.

3.1 Description of the system:

- .1 Identification of passenger and crew assembly stations.
- .2 Identification of escape routes.

3.2 Common assumptions

This method of estimating the evacuation duration is based on several idealized benchmark scenarios and the following assumptions are made:

- .1 passengers and crew will evacuate via the main escape route towards their assigned assembly station, as referred to in SOLAS regulation II-2/13;
- .2 passenger load and initial distribution are based on chapter 13 of the FSS Code;
- .3 full availability of escape arrangements is considered, unless otherwise stated;
- .4 assisting crew will immediately be at the evacuation duty locations ready to assist the passengers;
- .5 smoke, heat and toxic fire products are not considered to impact passenger/crew performance;
- .6 family group behaviour is not considered; and
- .7 ship motion, heel, and trim are not considered.

4 Scenarios to be considered

4.1 As a minimum, four scenarios (cases 1 to 4) should be considered for the analysis as follows. If more detailed data considering the crew distribution is available, it may be used.

- .1 case 1 (primary evacuation case, night) and case 2 (primary evacuation case, day) in accordance with chapter 13 of the FSS Code.
- .2 case 3 (secondary evacuation cases, night) and case 4 (secondary evacuation cases, day). In these cases only the main vertical zone, which generates the longest individual assembly duration, is further investigated. These cases utilize the same population demographics as the primary evacuation cases. The following are two alternatives that should be considered for both cases 3 and 4. For ro-ro passenger ships, alternative 1 should be the preferred option:
 - .1 alternative 1: one complete run of the stairways having largest capacity previously used within the identified main vertical zone is considered unavailable for the simulation; or

- .2 alternative 2: 50% of the persons in one of the main vertical zones neighbouring the identified main vertical zone are forced to move into the zone and to proceed to the relevant assembly station. The neighbouring zone with the largest population should be selected.

4.2 The following additional scenarios may be considered as appropriate:

- .1 case 5 (Open Deck): If an open deck is outfitted for use by passengers and its gross deck surface area is larger than 400 m² or accommodates more than 200 persons, the following, additional day case should be analysed: All persons are to be distributed as defined in the primary day case (case 2) considering the open deck as an additional public space with an initial density of 0.5 persons/m², calculated using the gross deck surface area.
- .2 case 6 (Embarkation): If separate embarkation and assembly stations are employed, an analysis of travel duration from assembly station to the entry point of LSA should be taken into account in the process of determining embarkation and launching duration (E+L). All persons which the ship is certified to carry are initially distributed according to the designated capacities of the assembly stations. The persons will move to the entry point of LSA according to the operator's procedures and designated routes. The time for boarding the LSA is determined during LSA prototype test and thus need not be addressed in detail in the simulation. However, congestion directly in front of the LSA should be considered as part of the simulation. These congestions need to be considered as blockage or obstacle for passenger and crew passing, i.e. generated with a LSA entry flow rate equal to the one observed during the LSA test.

4.3 If the total number of persons on board calculated, as indicated in the above cases, exceeds the maximum number of persons the ship will be certified to carry, the initial distribution of people should be scaled down so that the total number of persons is equal to what the ship will be certified to carry.

5 Performance standards

5.1 The following performance standards, as illustrated in figure 5.1, should be complied with:

Calculated total evacuation duration:

$$1.25 (R+T) + 2/3 (E+L) \leq n \quad (1)$$

$$(E+L) \leq 30 \text{ min} \quad (2)$$

5.2 In performance standard (1):

- .1 for ro-ro passenger ships, $n = 60$; and
- .2 for passenger ships other than ro-ro passenger ships, $n = 60$ if the ship has no more than three main vertical zones; and 80, if the ship has more than three main vertical zones.

5.3 Performance standard (2) complies with SOLAS regulation III/21.1.3.

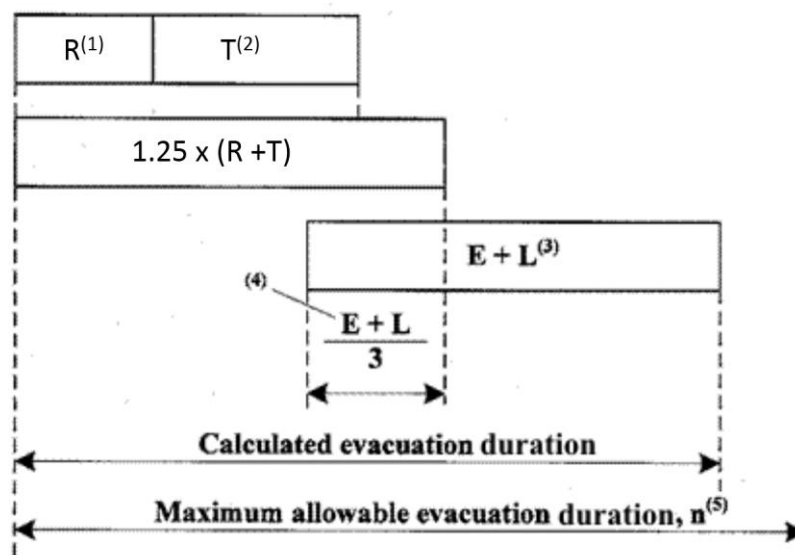

- (1) according to detailed specification of analysis method
 (2) calculated as in the annexes to these guidelines
 (3) maximum 30 min in compliance with SOLAS regulation III/21.1.3
 (4) overlap duration = $\frac{1}{3} (E+L)$
 (5) values of n (min) provided in 5.2

Figure 5.1

5.4 E + L should be calculated separately based upon:

- .1 results of full scale trials on similar ships and evacuation systems;
- .2 results of a simulation based embarkation analysis; or
- .3 data provided by the manufacturers. However, in this case, the method of calculation should be documented, including the value of correction factor used.

The embarkation and launching duration (E+L) should be clearly documented to be available in case of change of LSA.

5.5 For cases where neither of the three above methods can be used, (E+L) should be assumed equal to 30 min.

6 Documentation

The documentation of the analysis should report on the following items:

- .1 basic assumptions for the analysis;
- .2 schematic representation of the layout of the zones subjected to the analysis;
- .3 initial distribution of persons for each considered scenario;
- .4 methodology used for the analysis if different from these guidelines;

- .5 details of the calculations;
- .6 total evacuation duration;
- .7 identified congestion points; and
- .8 identified areas of counter and crossing flows.

7 Corrective actions

7.1 For new ships, if the total evacuation duration calculated is in excess of the allowed total evacuation duration, corrective actions should be considered at the design stage by suitably modifying the arrangements affecting the evacuation system in order to reach an acceptable total evacuation duration.

7.2 For existing ships, if the total evacuation duration calculated is in excess of the allowed total evacuation duration, onboard evacuation procedures should be reviewed with a view toward taking appropriate actions which would reduce congestion which may be experienced in locations as indicated by the analysis.

ANNEX 2

GUIDELINES FOR A SIMPLIFIED EVACUATION ANALYSIS FOR NEW AND EXISTING PASSENGER SHIPS

1 Specific assumptions

This method of estimating evacuation duration is basic in nature and, therefore, common evacuation analysis assumptions should be made as follows:

- .1 all passengers and crew will begin evacuation at the same time and will not hinder each other;
- .2 initial walking speed depends on the density of persons, assuming that the flow is only in the direction of the escape route, and that there is no overtaking;
- .3 people can move unhindered;
- .4 counterflow is accounted for by a counterflow correction factor; and
- .5 simplifications are accounted for in a correction factor and a safety factor. The safety factor has a value of 1.25.

2 Calculation of the evacuation duration

The following components should be considered:

- .1 response duration (R) should be 10 min for the night time scenarios and 5 min for the day time scenarios;
- .2 method to calculate the travel duration (T) is given in appendix 1; and
- .3 embarkation and launching duration (E+L).

3 Identification of congestion

Congestion is identified by the following criteria:

- .1 initial density equal to, or greater than, 3.5 persons/m²; and
- .2 the difference between inlet and outlet of calculated flows (F_c) is larger than 1.5 persons per second.

APPENDIX 1

METHOD TO CALCULATE THE TRAVEL DURATION (T)

1 Parameters to be considered

1.1 Clear width (W_c)

Clear width is measured off the handrail(s) for corridors and stairways and the actual passage width of a door in its fully open position.

1.2 Initial density of persons (D)

The initial density of persons in an escape route is the number of persons (p) divided by the available escape route area pertinent to the space where the persons are originally located and expressed in (p/m^2).

1.3 Speed of persons (S)

The speed (m/s) of persons along the escape route depends on the specific flow of persons (as defined in paragraph 1.4) and on the type of escape facility. People speed values are given in tables 1.1 (initial speed) and 1.3 below (speed after transition point as a function of specific flow).

1.4 Specific flow of persons (F_s)

Specific flow ($p/m/s$) is the number of escaping persons past a point in the escape route per unit time per unit of clear width W_c of the route involved. Values of F_s are given in tables 1.1 (initial F_s as a function of initial density) and 1.2 (maximum value) below.

Table 1.1² – Values of initial specific flow and initial speed as a function of density

Type of facility	Initial density D (p/m^2)	Initial specific flow F_s ($p/m/s$)	Initial speed of persons S (m/s)
Corridors	0	0	1.2
	0.5	0.65	1.2
	1,9	1.3	0.67
	3.2	0.65	0.20
	≥ 3.5	0.32	0.10

Table 1.2² – Value of maximum specific flow

Type of facility	Maximum specific flow F_s ($p/m/s$)
Stairs (down)	1.1
Stairs (up)	0.88
Corridors	1.3
Doorways	1.3

² Data derived from land-based stairs, corridors and doors in civil building and extracted from the publication *SFPE Fire Protection Engineering Handbook*, 2nd edition, NFPA 1995.

Table 1.3² – Values of specific flow and speed

Type of facility	Specific flow F_s (p/m/s)	Speed of persons S (m/s)
Stairs (down)	0	1.0
	0.54	1.0
	1.1	0.55
Stairs (up)	0	0.8
	0.43	0.8
	0.88	0.44
Corridors	0	1.2
	0.65	1.2
	1.3	0.67

1.5 Calculated flow of persons (F_c)

The calculated flow of persons (p/s) is the predicted number of persons passing a particular point in an escape route per unit time. It is obtained from:

$$F_c = F_s W_c \quad (1.5)$$

1.6 Flow duration (t_F)

Flow duration (s) is the total duration needed for N persons to move past a point in the egress system, and is calculated as:

$$t_F = N / F_c \quad (1.6)$$

1.7 Transitions

Transitions are those points in the egress system where the type (e.g. from a corridor to a stairway) or dimension of a route changes or where routes merge or ramify. In a transition, the sum of all the outlet-calculated flow is equal to the sum of all the inlet-calculated flow:

$$\sum F_c(\text{in})_i = \sum F_c(\text{out})_j \quad (1.7)$$

where:

$F_c(\text{in})_i$ = calculated flow of route (i) arriving at transition point
 $F_c(\text{out})_j$ = calculated flow of route (j) departing from transition point

1.8 Travel duration T , correction factor and counterflow correction factor

Travel duration T expressed in seconds as given by:

$$T = (\gamma + \delta) t_i \quad (1.8)$$

where:

γ = is the correction factor to be taken equal to 2 for cases 1 and 2 and 1.3 for cases 3 and 4;
 δ = is the counterflow correction factor to be taken equal to 0.3; and

² Data derived from land-based stairs, corridors and doors in civil building and extracted from the publication *SFPE Fire Protection Engineering Handbook*, 2nd edition, NFPA 1995.

t_i = is the highest travel duration expressed in seconds in ideal conditions resulting from application of the calculation procedure outlined in paragraph 2 of this appendix.

2 Procedure for calculating the travel duration in ideal conditions

2.1 Symbols

To illustrate the procedure, the following notation is used:

t_{stair} = stairway travel duration (s) of the escape route to the assembly station

t_{deck} = travel duration (s) to move from the farthest point of the escape route of a deck to the stairway

t_{assembly} = travel duration (s) to move from the end of the stairway to the entrance of the assigned assembly station

2.2 Quantification of flow duration

The basic steps of the calculation are the following:

- .1 Schematization of the escape routes as a hydraulic network, where the pipes are the corridors and stairways, the valves are the doors and restrictions in general, and the tanks are the public spaces.
- .2 Calculation of the density D in the main escape routes of each deck. In the case of cabin rows facing a corridor, it is assumed that the people in the cabins simultaneously move into the corridor; the corridor density is, therefore, the number of cabin occupants per corridor unit area calculated considering the clear width. For public spaces, it is assumed that all persons simultaneously begin the evacuation at the exit door (the specific flow to be used in the calculations is the door's maximum specific flow); the number of evacuees using each door may be assumed proportional to the door clear width.
- .3 Calculation of the initial specific flows F_s , by linear interpolation from table 1.1, as a function of the densities.
- .4 Calculation of the flow F_c for corridors and doors, in the direction of the correspondent assigned escape stairway.
- .5 Once a transition point is reached; formula (1.7) is used to obtain the outlet calculated flow(s) F_c . In cases where two or more routes leave the transition point, it is assumed that the flow F_c of each route is proportional to its clear width. The outlet specific flow(s), F_s , is obtained as the outlet calculated flow(s) divided by the clear width(s); two possibilities exist:
 - .1 F_s does not exceed the maximum value of table 1.2; the corresponding outlet speed (S) is then taken by linear interpolation from table 1.3, as a function of the specific flow; or

- .2 F_s exceeds the maximum value of table 1.2 above; in this case, a queue will form at the transition point, F_s is the maximum of table 1.2 and the corresponding outlet speed (S) is taken from table 1.3.
- .6 The above procedure is repeated for each deck, resulting in a set of values of calculated flows F_c and speed S , each entering the assigned escape stairway.
- .7 Calculation, from N (number of persons entering a flight or corridor) and from the relevant F_c , of the flow duration t_F of each stairway and corridor. The flow duration t_F of each escape route is the longest among those corresponding to each portion of the escape route.
- .8 Calculation of the travel duration t_{deck} from the farthest point of each escape route to the stairway, is defined as the ratio of length/speed. For the various portions of the escape route, the travel durations should be summed up if the portions are used in series, otherwise the largest among them should be adopted. This calculation should be performed for each deck; as the people are assumed to move in parallel on each deck to the assigned stairway, the dominant value t_{deck} should be taken as the largest among them. No t_{deck} is calculated for public spaces.
- .9 Calculation, for each stair flight, of its travel duration as the ratio of inclined stair flight length and speed. For each deck, the total stair travel duration, t_{stair} , is the sum of the travel durations of all stairs flights connecting the deck with the assembly station.
- .10 Calculation of the travel duration $t_{assembly}$ from the end of the stairway (at the assembly station deck) to the entrance of the assembly station.
- .11 The overall duration to travel along an escape route to the assigned assembly station is:
- $$t_i = t_F + t_{deck} + t_{stair} + t_{assembly} \quad (2.2.11)$$
- .12 The procedure should be repeated for both the day and night cases. This will result in two values (one for each case) of t_i for each main escape route leading to the assigned assembly station.
- .13 Congestion points are identified as follows:
- .1 in those spaces where the initial density is equal, or greater than, 3.5 persons/m²; and
- .2 in those locations where the difference between inlet and outlet calculated flows (F_c) is in more than 1.5 persons per second.
- .14 Once the calculation is performed for all the escape routes, the highest t_i should be selected for calculating the travel duration T using formula (1.8).

APPENDIX 2

EXAMPLE OF APPLICATION

1 General

1.1 This example provides an illustration on the application of the guidelines regarding cases 1 and 2. Therefore, it should not be viewed as a comprehensive and complete analysis nor as an indication of the data to be used.

1.2 The present example refers to an early design analysis of arrangements of a hypothetical new cruise ship. Moreover, the performance standard is assumed to be 60 min, as for ro-ro passenger ships. It should be noted that, at the time this example was developed, no such requirement is applicable for passenger ships other than ro-ro passenger ships. This example is, therefore, to be considered purely illustrative.

2 Ship characteristics

2.1 The example is limited to two main vertical zones (MVZ 1 and MVZ 2) of a hypothetical cruise ship. For MVZ 1, a night scenario is considered, hereinafter called case 1 (see figure 1) while a day scenario (case 2, see figure 2) is considered for MVZ 2.

2.2 In case 1, the initial distribution corresponds to a total of 449 persons located in the crew and passengers cabins as follows: 42 in deck 5; 65 in deck 6 (42 in the fore part and 23 in the aft part); 26 in deck 7; 110 in deck 9; 96 in deck 10; and 110 in deck 11. Deck 8 (assembly station) is empty.

2.3 In case 2, the initial distribution corresponds to a total of 1,138 persons located in the public spaces as follows: 469 in deck 6; 469 in deck 7; and 200 in deck 9. Deck 8 (assembly station) is empty.

3 Description of the system

3.1 *Identification of assembly stations*

For both MVZ 1 and MVZ 2, the assembly stations are located at deck 8, which is also the embarkation deck.

3.2 *Identification of escape routes*

3.2.1 In MVZ 1, the escape routes are as follows (see figure 3):

- .1 Deck 5 is connected with deck 6 (and then deck 8 where assembly stations are located) through one stair (stair A) in the fore part of the zone. Four corridors (corridors 1, 2, 3 and 4) and two doors (respectively door 1 and 2) connect the cabins with stair A. The clear widths and lengths are:

Item	Wc (clear width)[m]	Length [m]	Area [m ²]	Notes
MVZ1 – deck 5 – corridor 1	0.9	13	11.7	To door 1
MVZ1 – deck 5 – corridor 2	0.9	20	18	To door 1
MVZ1 – deck 5 – corridor 3	0.9	9.5	8.55	To door 2
MVZ1 – deck 5 – corridor 4	0.9	20	18	To door 1
MVZ1 – deck 5 – door 1	0.9	N.A.	N.A.	To stair A
MVZ1 – deck 5 – door 2	0.9	N.A.	N.A.	To stair A
MVZ1 – deck 5 – stair A	1.35	4.67	N.A.	Up to deck 6

- .2 Deck 6 is connected with deck 7 (and then deck 8) through two stairs (stairs A and B respectively in the fore and aft part of the zone). Four corridors (corridors 1, 2, 3 and 4) and two doors (doors 1 and 2) connect the fore cabins with stair A; and two corridors (corridors 5 and 6) and two doors (doors 3 and 4) connect the aft cabins with stair B. The clear widths and lengths are:

Item	Wc (clear width)[m]	Length [m]	Area [m ²]	Notes
MVZ1 – deck 6 – corridor 1	0.9	13	11.7	To door 1
MVZ1 – deck 6 – corridor 2	0.9	20	18	To door 1
MVZ1 – deck 6 – corridor 3	0.9	9.5	8.55	To door 2
MVZ1 – deck 6 – corridor 4	0.9	20	18	To door 1
MVZ1 – deck 6 – door 1	0.9	N.A.	N.A.	To stair A
MVZ1 – deck 6 – door 2	0.9	N.A.	N.A.	To stair A
MVZ1 – deck 6 – stair A	1.35	4.67	N.A.	Up to deck 7
MVZ1 – deck 6 – corridor 5	0.9	13	11.7	To door 3
MVZ1 – deck 6 – corridor 6	0.9	20	18	To door 4
MVZ1 – deck 6 – door 3	0.9	N.A.	N.A.	To stair B
MVZ1 – deck 6 – door 4	0.9	N.A.	N.A.	To stair B
MVZ1 – deck 6 – stair B	1.35	4.67	N.A.	Up to deck 7

- .3 Deck 7 is connected with deck 8 through stair C (stairs A and B coming from below stop at deck 7). Arrival of stairs A and B and deck 7 cabins are connected to stair C through 8 corridors, doors are neglected here in view of simplifying this example. The clear widths and lengths are:

Item	Wc (clear width)[m]	Length [m]	Area [m ²]	Notes
MVZ1 – deck 7 – corridor 1	0.9	6	5.4	To stair C
MVZ1 – deck 7 – corridor 2	0.9	9	8.1	To corridor 7
MVZ1 – deck 7 – corridor 3	0.9	15	13.5	To corridor 8
MVZ1 – deck 7 – corridor 4	0.9	6	5.4	To stairway C
MVZ1 – deck 7 – corridor 5	0.9	14	12.6	To corridor 7
MVZ1 – deck 7 – corridor 6	0.9	15	13.5	To corridor 8
MVZ1 – deck 7 – corridor 7	2.4	11	26.4	From stair B
MVZ1 – deck 7 – corridor 8	2.4	9	21.6	From stair A to stair C
MVZ1 – deck 7 – stair C	1.40	4.67	N.A.	Up to deck 8

- .4 Deck 11 is connected with deck 10 through a double stair (stair C) in the aft part of the zone. Two corridors (corridor 1 and 2) connect the cabins with stair C through two doors (respectively doors 1 and 2). The clear widths and lengths are:

Item	Wc (clear width)[m]	Length [m]	Area [m ²]	Notes
MVZ1 – deck 11 – corridor 1	0.9	36	32.4	To door 1
MVZ1 – deck 11 – corridor 2	0.9	36	32.4	To door 2
MVZ1 – deck 11 – door 1	0.9	N.A.	N.A.	To stair C
MVZ1 – deck 11 – door 2	0.9	N.A.	N.A.	To stair C
MVZ1 – deck 11 – stair C	2.8	4.67	N.A.	down to deck 10

- .5 Deck 10 has a similar arrangement as deck 11. The clear widths and lengths are:

Item	Wc (clear width)[m]	Length [m]	Area [m ²]	Notes
MVZ1 – deck 10 – corridor 1	0.9	36	32.4	To door 1
MVZ1 – deck 10 – corridor 2	0.9	36	32.4	To door 2
MVZ1 – deck 10 – door 1	0.9	N.A.	N.A.	To stair C
MVZ1 – deck 10 – door 2	0.9	N.A.	N.A.	To stair C
MVZ1 – deck 10 – stair C	2.8	4.67	N.A.	down to deck 9

- .6 Deck 9 has a similar arrangement as deck 11. The clear widths and lengths are:

Item	Wc (clear width)[m]	Length [m]	Area [m ²]	Notes
MVZ1 – deck 9 – corridor 1	0.9	36	32.4	To door 1
MVZ1 – deck 9 – corridor 2	0.9	36	32.4	To door 2
MVZ1 – deck 9 – door 1	0.9	N.A.	N.A.	To stair C
MVZ1 – deck 9 – door 2	0.9	N.A.	N.A.	To stair C
MVZ1 – deck 9 – stair C	2.8	4.67	N.A.	down to deck 8

- .7 Deck 8, people coming from decks 5, 6 and 7 (stair C) and from decks 11, 10 and 9 (stair C) enters the assembly station through paths 1 and 2. The clear widths and lengths are:

Item	Wc (clear width)[m]	Length [m]	Notes
MVZ1 – deck 8 – path 1	2.00	9.50	to assembly station
MVZ1 – deck 8 – path 2	2.50	7.50	to assembly station

3.2.2 In MVZ 2, the escape routes are as follows (see figure 4):

- .1 Deck 6 is connected with deck 7 (and then deck 8 where assembly stations are located) through two stairs (stair A and B respectively) in the fore part of the zone and through a double stair (stair C) in the aft part of the zone. Two doors (respectively door A and B) connect the public space with stairs A and B; and two doors (respectively door port side (PS) and door starboard side (SB)) connect the public space with stair C. The clear widths and lengths are:

Item	Wc (clear width)[m]	Length [m]	Notes
MVZ2 – deck 6 – door A	1	N.A.	
MVZ2 – deck 6 – door B	1	N.A.	
MVZ2 – deck 6 – door C PS	1.35	N.A.	
MVZ2 – deck 6 – door C SB	1.35	N.A.	
MVZ2 – deck 6 – stair A	1.4	4.67	up to deck 7
MVZ2 – deck 6 – stair B	1.4	4.67	up to deck 7
MVZ2 – deck 6 – stair C	3.2	4.67	up to deck 7

- .2 deck 7 is connected with deck 8 through the same arrangements as deck 6 to deck 7. The clear widths and lengths are:

Item	Wc (clear width)[m]	Length [m]	Notes
MVZ2 – deck 7 – door A	1.7	N.A.	
MVZ2 – deck 7 – door B	1.7	N.A.	
MVZ2 – deck 7 – door C PS	0.9	N.A.	
MVZ2 – deck 7 – door C SB	0.9	N.A.	
MVZ2 – deck 7 – stair A	2.05	4.67	up to deck 8
MVZ2 – deck 7 – stair B	2.05	4.67	up to deck 8
MVZ2 – deck 7 – stair C	3.2	4.67	up to deck 8

- .3 Deck 9 is connected with deck 8 through a double stair (stair C) in the aft part of the zone. Two doors (respectively door PS and door SB) connect the public space with stair C. The clear widths and lengths are:

Item	Wc (clear width)[m]	Length [m]	Notes
MVZ2 – deck 9 – door C PS	1	N.A.	
MVZ2 – deck 9 – door C SB	1	N.A.	
MVZ2 – deck 9 – stair C	3.2	4.67	down to deck 7

- .4 Deck 8, people coming from decks 6 and 7 (stairs A and B) enter directly the embarkation station (open deck) through doors A and B, while people coming from deck 9 (stair C) enter the assembly (muster) station through paths 1 and 2. The clear widths and lengths are:

Item	Wc (clear width)[m]	Length [m]	Notes
MVZ2 – deck 8 – door A	2.05	N.A.	to embarkation station
MVZ2 – deck 8 – door B	2.05	N.A.	to embarkation station
MVZ2 – deck 8 – path 1	2	9.5	to assembly station
MVZ2 – deck 8 – path 2	2.5	7.5	to assembly station

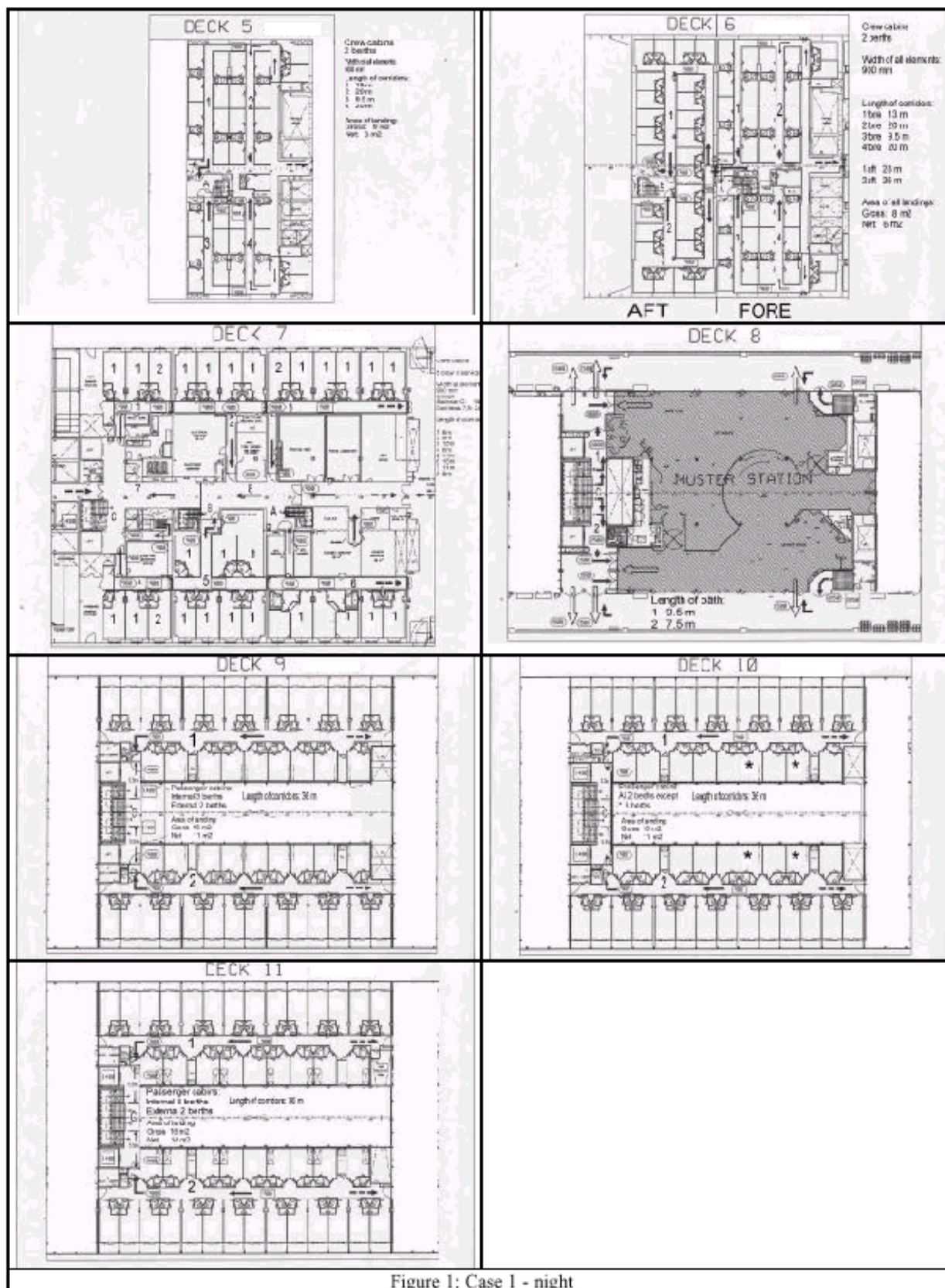

Figure 1: Case 1 - night

NOTE: "Muster Station" has the same meaning as "Assembly Station". Refer to *Indication of the assembly station in passenger ships (MSC/Circ.777)*.

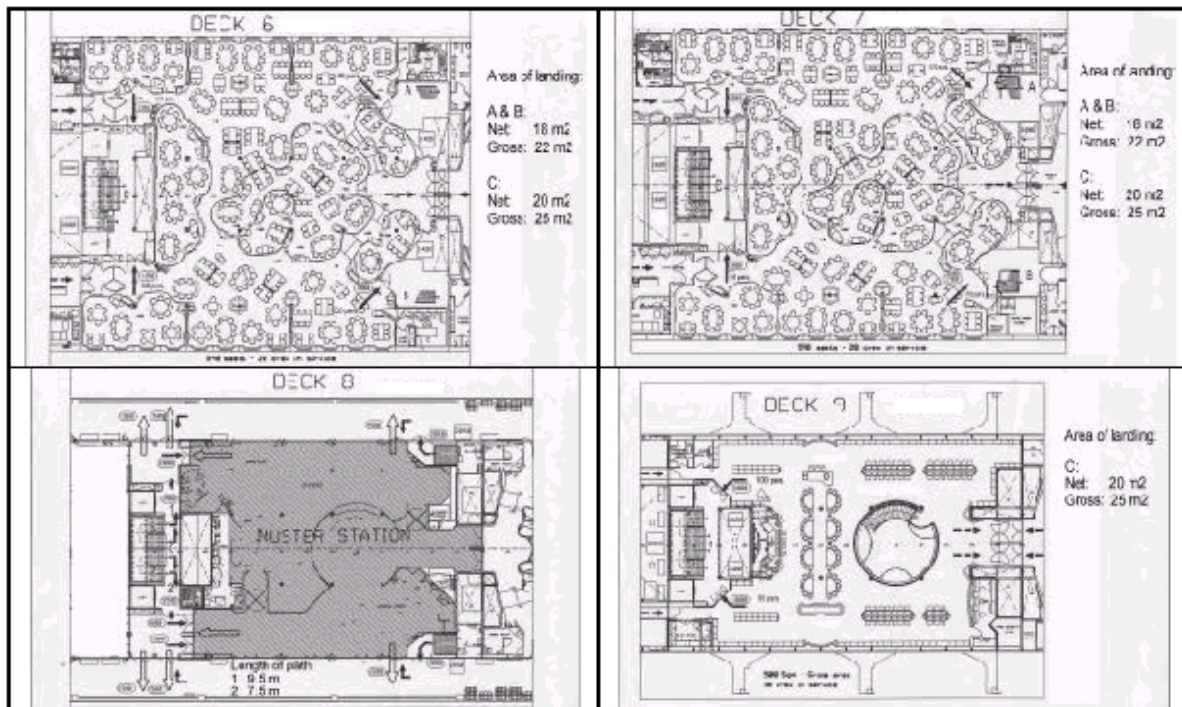

Figure 2: Case 2 - day

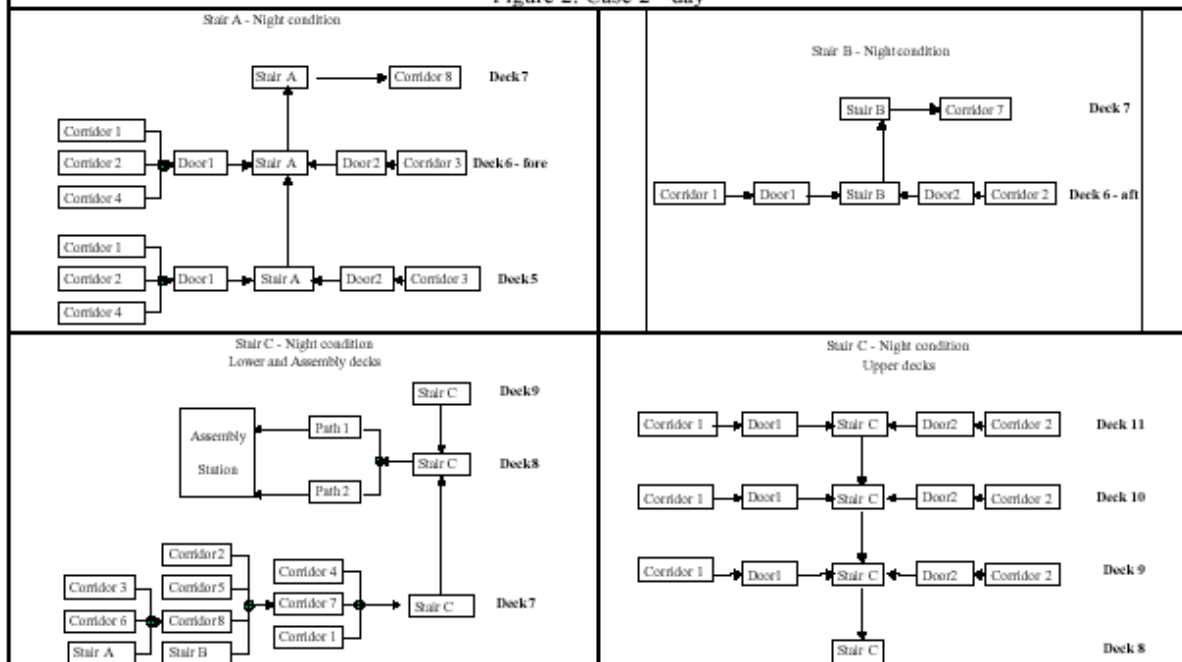

Figure 3: Case 1 (night) – hydraulic network schematisation

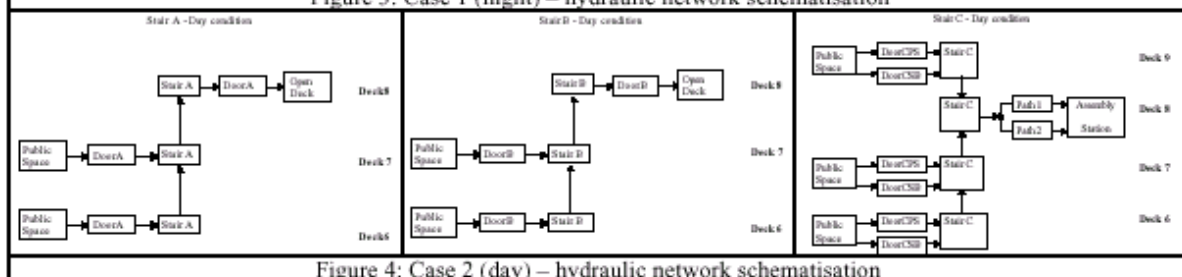

Figure 4: Case 2 (day) – hydraulic network schematisation

NOTE: "Muster Station" has the same meaning as "Assembly Station". Refer to *Indication of the assembly station in passenger ships (MSC/Circ.777)*.

4 Scenarios considered

4.1 Case 1 refers to a day scenario in MVZ 1, according to chapter 13 of the FSS Code, the 449 persons are initially distributed as follows: 42 in deck 5; 65 in deck 6 (42 in the fore part and 23 in the aft part); 26 in deck 7; 110 in deck 9; 96 in deck 10; and 110 in deck 11. Deck 8 (assembly station) is empty. In accordance with paragraph 2.2 of appendix 1 to the guidelines, all persons in the cabins are assumed to simultaneously move into the corridors. The corresponding initial conditions are:

MVZ 1 – Corridors	Persons	Initial density D (p/m²)	Initial specific flow Fs (p/m/s)	Calculated flow Fc (p/s)	Initial speed of persons S (m/s)
Deck 5 – corridor 1	11	0.94	0.85	0.77	1.03
Deck 5 – corridor 2	12	0.67	0.73	0.65	1.14
Deck 5 – corridor 3	8	0.94	0.85	0.77	1.04
Deck 5 – corridor 4	11	0.61	0.7	0.63	1.16
Deck 6 – corridor 1	11	0.94	0.85	0.77	1.03
Deck 6 – corridor 2	12	0.67	0.73	0.65	1.14
Deck 6 – corridor 3	8	0.94	0.85	0.77	1.04
Deck 6 – corridor 4	11	0.61	0.7	0.63	1.16
Deck 6 – corridor 5	11	0.94	0.85	0.77	1.03
Deck 6 – corridor 6	12	0.67	0.73	0.65	1.14
Deck 7 – corridor 1	4	0.74	0.76	0.69	1.11
Deck 7 – corridor 2	4	0.49	0.64	0.58	1.2
Deck 7 – corridor 3	6	0.44	0.58	0.52	1.2
Deck 7 – corridor 4	4	0.74	0.76	0.69	1.11
Deck 7 – corridor 5	6	0.48	0.62	0.56	1.2
Deck 7 – corridor 6	2	0.15	0.19	0.17	1.2
Deck 7 – corridor 7	0	0	N.A.	N.A.	N.A.
Deck 7 – corridor 8	0	0	N.A.	N.A.	N.A.
Deck 11 – corridor 1	55	1.7	1.21	1.09	0.75
Deck 11 – corridor 2	55	1.7	1.21	1.09	0.75
Deck 10 – corridor 1	48	1.48	1.11	1	0.83
Deck 10 – corridor 2	48	1.48	1.11	1	0.83
Deck 9 – corridor 1	55	1.7	1.21	1.09	0.74
Deck 9 – corridor 2	55	1.7	1.21	1.09	0.74

MVZ 1 – Stairs, doors & corridors	Persons (N)		Specific flow Fs in (p/m/s)	Max. specific flow Fs (p/m/s)	Specific flow Fs (p/m/s)	Cal- culated flow Fc (p/s)	Speed of persons S (m/s)	Queue	Comments	Notes
	From current route	Total including those from other routes								
Deck 5 – door 1	34	34	2.28	1.3	1.3	1.17	N.A.	Yes	From corridors 1, 2 and 4	1
Deck 5 – door 2	8	8	1.85	1.3	0.85	0.77	N.A.		From corridor 3	1
Deck 5 – stair A	42	42	1.43	0.88	0.88	1.188	0.44	Yes	From doors 1 and 2	1, 2
Deck 6 – door 1	34	34	2.58	1.30	1.3	1.17	N.A.	Yes	From corridors 1, 2, and 4;	1
Deck 6 – door 2	8	8	0.85	1.30	0.85	0.77	N.A.		From corridor 3	1
Deck 6 – stair A	42	84	2.32	0.88	0.88	1.188	0.44	Yes	From doors 1 and 2, from deck 5	1, 2
Deck 6 – door 3	11	11	0.85	1.30	0.85	0.77	N.A.		From corridor 5	1
Deck 6 – door 4	12	12	0.73	1.30	0.81	0.73	N.A.		From corridor 4	1
Deck 6 – stair B	23	23	1.05	0.88	0.88	1.188	0.44	Yes	From doors 3 and 4	1, 2
Deck 7 – corridor 8	8	92	0.78	1.3	0.78	1.88	1.09		From corridors 3 and 6, from deck 6, stair A	1, 3
Deck 7 – corridor 7	18	125	1.75	1.3	1.3	3.12	0.67	Yes	From corridors 2, 5 and 8, from deck 6, stair B	1, 4
Deck 7 – stair C	8	133	3.21	0.88	0.88	1.232	0.44	Yes	From corridors 1, 4 and 7; up to deck 8	1, 2, 5
Deck 11 – door 1	55	55	1.21	1.3	1.21	1.09	N.A.		To stair C	1
Deck 11 – door 2	55	55	1.21	1.3	1.21	1.09	N.A.		To stair C	1
Deck 11 – stair C	110	110	0.78	1.1	0.78	2.17	0.81		Down to deck 10	1, 2
Deck 10 – door 1	48	48	1.11	1.3	1.11	1	N.A.		To stair C	1
Deck 10 – door 2	48	48	1.11	1.3	1.11	1	N.A.		To stair C	1
Deck 10 – stair C	96	206	1.49	1.1	1.10	3.08	0.55	Yes	Down to deck 9	1, 2
Deck 9 – door 1	55	55	1.21	1.3	1.21	1.09	N.A.		To stair C	1
Deck 9 – door 2	55	55	1.21	1.3	1.21	1.09	N.A.		To stair C	1
Deck 9 – stair C	110	316	1.88	1.1	1.10	3.08	0.55	Yes	Down to deck 8	1, 2
Deck 8 – path 1	0	200	0.96	1.3	0.96	1.92	0.95		To assembly stat	1, 6
Deck 8 – path 2	0	249	0.96	1.3	0.96	2.4	0.95		To assembly stat	1, 6

Notes:

- 1 The specific flow "Fs in" is the specific flow entering the element of the escape route; the maximum specific flow is the maximum allowable flow given in table 1.3 of appendix 1 of the guidelines; the specific flow is the one applicable for the calculations i.e. the minimum between "Fs in" and the maximum allowable; when "Fs in" is greater than the maximum allowable, a queue is formed.
 - 2 Some stairs are used by both persons coming from below (or above) and persons coming from the current deck considered; in making the calculation for a stair connecting deck N to deck N+1 (or deck N-1), the persons to be considered are those entering the stairs at deck N plus those coming from all decks below (or above) deck N.
 - 3 At deck 7, 8 persons initially move from the cabins into corridor 8 and 84 persons arrive to corridor 8 from deck 6, stair A; the total is therefore 92 persons.
 - 4 At deck 7, 18 persons initially move from the cabins into corridor 7, 23 persons arrive to corridor 7 from deck 6 stair B and 84 persons arrive to corridor 8 from deck 7, corridor 7; the total is, therefore, 125 persons.
 - 5 At deck 7, 8 persons initially move from the cabins directly to the stair C and 125 persons arrive to stair C from corridor 8; the total is therefore 133 persons.
 - 6 At deck 8 (assembly station), no persons are initially present; therefore, the escape routes on this deck are then used by the total number of persons arriving from above and/or below.
- 4.2 Case 2 refers to a day scenario in MVZ 2, according to chapter 13 of the FSS Code, the 1,138 persons are initially distributed as follows: 469 in deck 6; 469 in deck 7; and 200 in deck 9. Deck 8 (assembly station) is initially empty. In accordance with paragraph 2.2 of appendix 1 to the guidelines, all persons are assumed to simultaneously begin the evacuation and use the exit doors at their maximum specific flow. The corresponding initial conditions are:

MVZ 2 – Doors	Persons	Initial density D (p/m²)	Initial Specific flow Fs (p/m/s)	Calculated flow Fc (p/s)	Initial speed of persons S (m/s)
Deck 6 – door A	100	N.A.	1.3	1.3	N.A.
Deck 6 – door B	100	N.A.	1.3	1.3	N.A.
Deck 6 – door C PS	134	N.A.	1.3	1.76	N.A.
Deck 6 – door C SB	135	N.A.	1.3	1.76	N.A.
Deck 7 – door A	170	N.A.	1.3	2.21	N.A.
Deck 7 – door B	170	N.A.	1.3	2.21	N.A.
Deck 7 – door C PS	65	N.A.	1.3	1.17	N.A.
Deck 7 – door C SB	64	N.A.	1.3	1.17	N.A.
Deck 9 – door C SB	100	N.A.	1.3	1.3	N.A.
Deck 9 – door C PS	100	N.A.	1.3	1.3	N.A.

MVZ 2 – Stairs	Persons (N)		Specific flow Fs in (p/m/s)	Max. specific flow Fs (p/m/s)	Specific flow Fs (p/m/s)	Calculated flow Fc (p/s)	Speed of persons S (m/s)	Queue	Comments	Notes
	From current route	Total including those from other routes								
Deck 6 – stair A	100	100	0.93	0.88	0.88	1.23	0.44	Yes	up to deck 7	1
Deck 6 – stair B	100	100	0.93	0.88	0.88	1.23	0.44	Yes	up to deck 7	1
Deck 6 – stair C	269	269	1.1	0.88	0.88	2.82	0.44	Yes	up to deck 7	1
Deck 7 – stair A	170	270	1.68	0.88	0.88	1.8	0.44	Yes	up to deck 8	1, 2
Deck 7 – stair B	170	270	1.68	0.88	0.88	1.8	0.44	Yes	up to deck 8	1, 2
Deck 7 – stair C	129	398	1.61	0.88	0.88	2.82	0.44	Yes	up to deck 8	1, 2
Deck 9 – stair C	200	200	0.81	1.1	0.81	2.60	0.78		down to deck 8	
Deck 8 – path 1	0	266	1.2	1.3	1.2	2.41	0.75		from decks 7 and 9	1, 3
Deck 8 – path 2	0	332	1.2	1.3	1.2	3.01	0.75		from decks 7 and 9	1, 3
Deck 8 – door A	0	270	0.88	1.3	0.88	1.8	N.A.		from deck 7	1, 3
Deck 8 – door B	0	270	0.88	1.3	0.88	1.8	N.A.		from deck 7	1, 3

Notes:

- 1 The specific flow "Fs in" is the specific flow entering the element of the escape route; the maximum specific flow is the maximum allowable flow given in table 1.3 of appendix 1 of the guidelines; the specific flow is the one applicable for the calculations i.e. the minimum between "Fs in" and the maximum allowable; when "Fs in" is greater than the maximum allowable, a queue is formed.
- 2 Some stairs are used by both persons coming from below (or above) and persons coming from the current deck considered; in making the calculation for a stair connecting deck N to deck N+1 (or deck N-1), the persons to be considered are those entering the stairs at deck N plus those coming from all decks below (or above) deck N.
- 3 At deck 8 (assembly station), no persons are initially present; therefore, the escape routes on this deck are then used by the total number of persons arriving from above and/or below.

5 Calculation of t_F , t_{deck} and t_{stair}

5.1 For case 1:

Item	Persons N	Length L (m)	Calculated flow Fc (p/s)	Speed S (m/s)	Flow dur. t_F (s) $t_F = N / Fc$	Deck or stairs dur., t_{deck} , t_{stairs} $T = L/S$	Entering
Deck 5 – corridor 1	11	13	0.77	1.03	14.3	12.6	Door 1
Deck 5 – corridor 2	12	20	0.65	1.14	18.3	17.6	Door 1
Deck 5 – corridor 3	8	9.5	0.77	1.04	10.4	9.2	Door 2
Deck 5 – corridor 4	11	20	0.63	1.16	17.4	17.3	Door 1
Deck 5 – door 1	34	N.A.	1.17	N.A.	29.1	N.A.	Stair A
Deck 5 – door 2	8	N.A.	0.77	N.A.	10.4	N.A.	Stair A
Deck 5 – stair A	42	4.67	1.188	0.44	35.4	10.6	Deck 6
Deck 6 – corridor 1	11	13	0.77	1.03	14.3	12.6	Door 1
Deck 6 – corridor 2	12	20	0.65	1.14	18.3	17.6	Door 1
Deck 6 – corridor 3	8	9.5	0.77	1.04	10.4	9.2	Door 2
Deck 6 – corridor 4	11	20	0.63	1.16	17.4	17.3	Door 1
Deck 6 – door 1	34	N.A.	1.17	N.A.	29.1	N.A.	Stair A
Deck 6 – door 2	8	N.A.	0.77	N.A.	10.4	N.A.	Stair A
Deck 6 – stair A	84	4.67	1.188	0.44	70.7	10.6	Deck 7
Deck 6 – corridor 5	11	13	0.77	1.03	14.3	12.6	Door 3
Deck 6 – corridor 6	12	20	0.65	1.14	18.3	17.6	Door 4
Deck 6 – door 3	11	N.A.	0.77	N.A.	14.3	N.A.	Stair B
Deck 6 – door 4	12	N.A.	0.65	N.A.	18.3	N.A.	Stair B
Deck 6 – stair B	23	4.67	1.188	0.44	19.4	10.6	Deck 7
Deck 7 – corridor 1	4	6	0.69	1.11	5.8	5.4	Stair C
Deck 7 – corridor 2	4	9	0.58	1.2	6.9	7.5	Corridor 7
Deck 7 – corridor 3	6	15	0.52	1.2	11.5	12.5	Corridor 8
Deck 7 – corridor 4	4	6	0.69	1.11	5.8	5.4	Stair C
Deck 7 – corridor 5	6	14	0.56	1.2	10.8	11.7	Corridor 7
Deck 7 – corridor 6	2	15	0.17	1.2	11.5	12.5	Corridor 8
Deck 7 – corridor 8	92	9	1.88	1.09	48.9	8.2	Corridor 7
Deck 7 – corridor 7	125	11	3.12	0.67	40.1	16.4	Stair C
Deck 7 – stair C	133	4.67	1.232	0.44	108	10.6	Deck 8
Deck 11– corridor 1	55	36	1.09	0.75	50.7	48.2	Door 1
Deck 11– corridor 2	55	36	1.09	0.75	50.7	48.2	Door 2
Deck 11 – door 1	55	N.A.	1.09	N.A.	50.7	N.A.	Stair C
Deck 11 – door 2	55	N.A.	1.09	N.A.	50.7	N.A.	Stair C
Deck 11 – stair C	110	4.67	2.17	0.81	50.7	5.8	Deck 10
Deck 10– corridor 1	48	36	1	0.83	48.2	43.5	Door 1
Deck 10– corridor 2	48	36	1	0.83	48.2	43.5	Door 2
Deck 10 – door 1	48	N.A.	1	N.A.	48.2	N.A.	Stair C
Deck 10 – door 2	48	N.A.	1	N.A.	48.2	N.A.	Stair C
Deck 10 – stair C	206	4.67	3.08	0.55	66.9	8.5	Deck 9
Deck 9 – corridor 1	55	36	1.09	0.74	50.7	48.4	Door 1
Deck 9 – corridor 2	55	36	1.09	0.74	50.7	48.4	Door 2
Deck 9 – door 1	55	N.A.	1.09	N.A.	50.7	N.A.	Stair C
Deck 9 – door 2	55	N.A.	1.09	N.A.	50.7	N.A.	Stair C
Deck 9 – stair C	316	4.67	3.08	0.55	102.6	8.5	Deck 8

5.2 For case 2: since in this particular arrangement there are no corridors, the deck duration is zero.

Item	Persons N	Length L (m)	Calculated flow Fc (p/s)	Speed S (m/s)	Flow dur. t_F (s) $t_F = N / Fc$	Deck or stairs dur., t_{deck}, t_{stairs} $t = L/S$	Entering
Deck 6 – door A	100	N.A.	1.3	N.A.	76.9	N.A.	Stair A
Deck 6 – door B	100	N.A.	1.3	N.A.	76.9	N.A.	Stair B
Deck 6 – door C PS	134	N.A.	1.76	N.A.	76.4	N.A.	Stair C
Deck 6 – door C SB	135	N.A.	1.76	N.A.	76.9	N.A.	Stair C
Deck 6 – stair A	100	4.67	1.23	0.44	81.2	10.6	Deck 7
Deck 6 – stair B	100	4.67	1.23	0.44	81.2	10.6	Deck 7
Deck 6 – stair C	269	4.67	2.82	0.44	95.5	10.6	Deck 7
Deck 7 – door A	170	N.A.	2.21	N.A.	76.9	N.A.	Stair A
Deck 7 – door B	170	N.A.	2.21	N.A.	76.9	N.A.	Stair B
Deck 7 – door C PS	65	N.A.	1.17	N.A.	55.6	N.A.	Stair C
Deck 7 – door C SB	64	N.A.	1.17	N.A.	54.7	N.A.	Stair C
Deck 7 – stair A	270	4.67	1.8	0.44	149.7	10.6	Deck 8
Deck 7 – stair B	270	4.67	1.8	0.44	149.7	10.6	Deck 8
Deck 7 – stair C	398	4.67	2.82	0.44	141.3	10.6	Deck 8
Deck 8 – door A	270	N.A.	1.8	N.A.	149.7	N.A.	Embarkation
Deck 8 – door B	270	N.A.	1.8	N.A.	149.7	N.A.	Embarkation
Deck 9 – door PS	100	N.A.	1.3	N.A.	76.9	N.A.	Stair C
Deck 9 – door SB	100	N.A.	1.3	N.A.	76.9	N.A.	Stair C
Deck 9 – stair C	200	4.67	2.6	0.78	76.9	6	Deck 8

6 Calculation of $t_{assembly}$

6.1 Case 1: In this case, all the 429 persons use stair C (316 coming from above deck 8 and 133 from below) and, once arrived at deck 8, need to travel on deck 8 to reach the assembly station using either path 1 or path 2. The corresponding duration is as follows:

Item	Persons N	Length L (m)	Calculated flow Fc (p/s)	Speed S (m/s)	Flow dur. t_F (s) $t_F = N / Fc$	$t_{assembly}$ $t = L/S$	Entering
Deck 8 – path 1	200	9.5	1.92	0.95	104.4	10	Assembly station
Deck 8 – path 2	249	7.5	2.4	0.95	103.9	7.9	Assembly station

6.2 Case 2: In this case, all the persons using stair C (totalling 598), once arrived at deck 8, need to travel through on deck 8 to reach the assembly station using either path 1 or path 2. The corresponding duration is as follows:

Item	Persons N	Length L (m)	Calculated flow Fc (p/s)	Speed S (m/s)	Flow dur. t_F (s) $t_F = N / F_c$	$t_{assembly}$ $t = L/S$	Entering
Deck 8 – path 1	266	9.5	2.41	0.75	110.5	12.7	Assembly station
Deck 8 – path 2	332	7.5	3.01	0.75	110.3	10	Assembly station

7 Calculation of T

7.1 Case 1: The travel duration T, according to appendix 1 to the interim guidelines, is the maximum t_i (equation 2.2.11) multiplied by 2.3 (sum of correction factor and counterflow correction factor). The maximum values of t_i for each escape route are given in the following:

Escape route on	T_{deck}	t_r	t_{stair}	$t_{assembly}$	t_i	T	Notes
Deck 11	48.2	104.4	22.7	10	185.3	426.2	1
Deck 10	43.5	104.4	17	10	174.8	402	1, 2
Deck 9	48.4	104.4	8.5	10	171.3	394	1, 2
Deck 8	0	104.4	0	10	114.4	286.1	
Deck 7	37.1	108	10.6	10	163.9	377	1
Deck 6 – stair A (fore)	42.4	108	21.2	10	179.6	413.1	1, 3
Deck 6 – stair B (aft)	34	108	21.2	10	170.2	391.5	1, 3
Deck 5	42.2	108	31.8	10	190.2	437.5	1, 3

Notes:

- 1 The flow duration, t_r , is the maximum flow duration recorded on the whole escape route from the deck where persons started evacuating up to the assembly station.
- 2 The travel duration on the stairways (t_{stair}) is the total duration necessary to travel along all the stairs from the deck where persons originally started evacuating up to the deck where the assembly station is located; in the present case, t_{stair} for persons moving down from deck 11 is, therefore, the sum of t_{stair} from deck 11 to 10 (5.7 s), from deck 10 to 9 (8.5 s) and from deck 9 to 8 (8.5 s), in total 22.7 s; similarly for the other cases.
- 3 The travel duration on the stairways (t_{stair}) is the total duration necessary to travel along all the stairs from the deck where persons originally started evacuating up to the deck where the assembly station is located; in the present case, t_{stair} for persons moving up from deck 5 is, therefore, the sum of t_{stair} from deck 5 to 6 (10.6 s.), from deck 6 to 7 (10.6 s) and from deck 7 to 8 (10.6 s), in total 31.8 s; similarly for the other cases.

Accordingly, the corresponding value of T is 437.5 s.

7.2 Case 2: The travel duration T, according to appendix 1 to the guidelines, is the maximum t_i equation 2.2.11) multiplied by 2.3 (sum of correction factor and counterflow correction factor). The maximum values of t_i for each escape route are given in the following:

Escape route on	T _{deck}	t _f	t _{stair}	t _{assembly}	t _i	T	Notes
Deck 9	0	110.4	6	12.7	168.3	387.2	1, 2
Deck 8	0	110.4	0	12.7	162.4	373.4	
Deck 7 – stair A	0	149.7	10.6	0	160.3	368.6	
Deck 7 – stair B	0	149.7	10.6	0	160.3	368.6	
Deck 7 – stair C	0	141.3	10.6	12.7	164.6	378.7	2
Deck 6 – stair A	0	149.7	21.2	0	170.9	393	1, 3
Deck 6 – stair B	0	149.7	21.2	0	170.9	393	1, 3
Deck 6 – stair C	0	141.3	21.2	12.7	175.2	403.1	1, 2, 3

Notes:

- 1 The flow duration, t_f , is the maximum flow duration recorded on the whole escape route from the deck where persons started evacuating up to the assembly station.
- 2 In this example, stairs A and B are already leading to the embarkation station; therefore, only those escape routes passing through stair C need additional duration, $t_{assembly}$, to reach the assembly station.
- 3 The travel duration on the stairways (t_{stair}) is the total duration necessary to travel along all the stairs from the deck where persons originally started evacuating up to the deck where the assembly station is located; in the present case, t_{stair} for persons moving from deck 6 is therefore the sum of t_{stair} from deck 6 to 7 (10.6 s) and from deck 7 to 8 (10.6 s).

Accordingly, the corresponding value of T is 403.1 s.

8 Identification of congestion

8.1 Case 1: Congestion takes place on deck 5 (door 1 and stair A), deck 6 (door 1, stairs A and B), deck 7 (corridor 7 and stair C), deck 10 (stair C) and deck 9 (stair C). However, since the total duration is below the limit (see paragraph 9.1 of this example) no design modifications are needed.

8.2 Case 2: Congestion takes place on deck 6 (stairs A, B and C) and deck 7 (stairs A, B and C). However, since the total duration is below the limit (see paragraph 9.2 of this example) no design modifications are needed.

9 Performance standard

9.1 Case 1: The total evacuation duration, according to paragraph 5.1 of the revised guidelines is as follows:

$$1.25 (R+T) + 2/3 (E+L) = 1.25 \cdot x (10' + 7'18") + 20 = 41' 38" \quad (9.1)$$

where:

(E+L) is assumed to be 30'
R = 10' (night case)
T = 7' 18"

9.2 Case 2: The total evacuation duration, according to paragraph 5.1 of the revised guidelines is as follows:

$$1.25 (R+T) + 2/3 (E+L) = 1.25 \times (5' + 6' 43'') + 20 = 34' 39'' \quad (9.2)$$

where:

(E+L) is assumed to be 30'
R = 5' (day case)
T = 6' 43".

ANNEX 3
GUIDELINES FOR AN ADVANCED EVACUATION ANALYSIS
OF NEW AND EXISTING PASSENGER SHIPS³

1 Specific assumptions

This method of estimating the evacuation duration is based on several idealized benchmark scenarios and the following assumptions are made:

- .1 the passengers and crew are represented as unique individuals with specified individual abilities and response durations;
- .2 a safety factor having a value of 1.25 is introduced in the calculation to take account of model omissions, assumptions, and the limited number and nature of the benchmark scenarios considered.

2 Calculation of the evacuation duration

The following components should be included in the calculation of the evacuation duration as specified in the appendix:

- .1 the response duration (R) distribution to be used in the calculations;
- .2 the method to determine the travel duration (T); and
- .3 embarkation and launching duration (E+L).

3 Identification of congestion

3.1 Congestion within regions is identified by local population densities exceeding 4 p/m² for significant duration. These levels of congestion may or may not be significant to the overall assembly process.

3.2 If any identified congestion region is found to persist for longer than 10% of the simulated total assembly duration (t_A), it is considered to be significant.

³ **Note:** Advanced evacuation analysis is taken to mean a computer-based simulation that represents each occupant as an individual that has a detailed representation of the layout of a ship and represents the interaction between the occupants and the layout.

APPENDIX 1

METHOD TO DETERMINE THE TRAVEL DURATION (T) BY SIMULATION TOOLS FOR THE ADVANCED EVACUATION ANALYSIS

1 Characteristics of the models

- 1.1 Each person (p) is represented in the model individually.
- 1.2 The abilities of each person are determined by a set of parameters, some of which are probabilistic.
- 1.3 The movement of each person is recorded.
- 1.4 The parameters should vary among the individuals of the population.
- 1.5 The basic rules for personal decisions and movements are the same for everyone, described by a universal algorithm.
- 1.6 The time difference between the actions of any two persons in the simulation should be not more than one second of simulated time, e.g. all persons proceed with their action in one second (a parallel update is necessary).

2 Parameters to be used

- 2.1 In order to facilitate their use, the parameters are grouped into the same 4 categories as used in other industrial fields, namely: GEOMETRICAL, POPULATION, ENVIRONMENTAL and PROCEDURAL.
- 2.2 Category GEOMETRICAL: layout of escape routes, their obstruction and partial unavailability, initial passenger and crew distribution conditions.
- 2.3 Category POPULATION: ranges of parameters of persons and population demographics.
- 2.4 Category ENVIRONMENTAL: static and dynamic conditions of the ship.
- 2.5 Category PROCEDURAL: crew members available to assist in emergency.

3 Recommended values of the parameters

3.1 *Category GEOMETRICAL*

3.1.1 *General*

The evacuation analysis specified in this annex is aimed at measuring the performance of the ship in reproducing benchmark scenarios rather than simulating an actual emergency situation. Four benchmark cases should be considered, namely cases 1, 2, 3 and 4 (refer to paragraph 4 for detailed specifications) corresponding to primary evacuation cases (cases 1 and 2, where all the escape routes should be assumed to be in operation) and secondary evacuation cases (cases 3 and 4, where some of the escape route should be assumed to be unavailable).

3.1.2 Layout of escape routes – primary evacuation cases (cases 1 and 2): Passengers and crew should be assumed to proceed along the primary escape routes and to know their ways up to the assembly stations; to this effect, signage, low-location lighting, crew training and other relevant aspects connected with the evacuation system design and operation should be assumed to be in compliance with the requirements set out in IMO instruments.

3.1.3 Layout of escape routes – secondary evacuation cases (cases 3 and 4): Those passengers and crew who were previously assigned to the now unavailable primary escape route should be assumed to proceed along the escape routes determined by the ship designer.

3.1.4 Initial passenger and crew distribution condition. The occupant distribution should be based upon the cases defined in chapter 13 of the FSS Code, as outlined in section 4.

3.2 **Category POPULATION**

3.2.1 This describes the make-up of the population in terms of age, gender, physical attributes and response durations. The population is identical for all scenarios with the exception of the response duration and passenger initial locations. The population is made of the following mix:

Table 3.1 – Population's composition (age and gender)

Population groups – passengers	Percentage of passengers (%)
Females younger than 30 years	7
Females 30-50 years old	7
Females older than 50 years	16
Females older than 50, mobility impaired (1)	10
Females older than 50, mobility impaired (2)	10
Males younger than 30 years	7
Males 30-50 years old	7
Males older than 50 years	16
Males older than 50, mobility impaired (1)	10
Males older than 50, mobility impaired (2)	10
Population groups – crew	Percentage of crew (%)
Crew females	50
Crew males	50

All of the attributes associated with this population distribution should consist of a statistical distribution within a fixed range of values. The range is specified between a minimum and maximum value with a uniform random distribution.

3.2.2 *Response duration*

The response duration distributions for the benchmark scenarios should be truncated logarithmic normal distributions⁴ as follows:

⁴ "Recommendations on the Nature of the Passenger Response Time Distribution to be used in the MSC.1033 Assembly Time Analysis Based on Data Derived from Sea Trials", Galea, E. R., Deere, S., Sharp, G., Fillips, L., Lawrence, P., and Gwunne, S., The Transaction of The Royal Institution of Naval Architects, Part A – International Journal of Maritime Engineering ISSN 14798751.2007.

For Cases 1 and 3 (Night cases):

$$y = \frac{1.01875}{\sqrt{2\pi}0.84(x-400)} \exp\left[-\frac{(\ln(x-400)-3.95)^2}{2 \times 0.84^2}\right] \quad (3.2.2.1)$$

$$400 < x < 700$$

For Cases 2 and 4 (Day cases):

$$y = \frac{1.00808}{\sqrt{2\pi}0.94x} \exp\left[-\frac{(\ln(x)-3.44)^2}{2 \times 0.94^2}\right] \quad (3.2.2.2)$$

$$0 < x < 300$$

where x is the response duration in seconds and y is the probability density at response duration x.

3.2.3 Unhindered travel speeds on flat terrain (e.g. corridors)

The maximum unhindered travel speeds to be used are those derived from data published by Ando⁵ which provides male and female walk rates as a function of age. These are distributed according to figure 3.1 and represented by approximate piecewise functions shown in table 3.3.

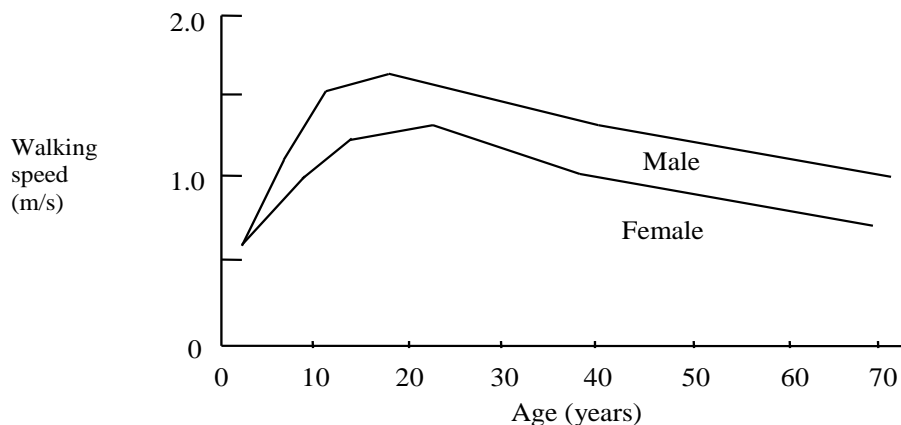

Figure 3.1 – Walking speeds as a function of age and gender

⁵ Ando K, Ota H, and Oki T, *Forecasting The Flow Of People*, Railway Research Review, (45), pp 8-14, 1988.

Table 3.3 – Regression formulation for mean travel speed values⁶

Gender	Age (years)	Speed (m/s)
Female	2 - 8.3	$0.06 * \text{age} + 0.5$
	8.3 - 13.3	$0.04 * \text{age} + 0.67$
	13.3 - 22.25	$0.02 * \text{age} + 0.94$
	22.25 - 37.5	$-0.018 * \text{age} + 1.78$
	37.5 - 70	$-0.01 * \text{age} + 1.45$
Male	2 - 5	$0.16 * \text{age} + 0.3$
	5 - 12.5	$0.06 * \text{age} + 0.8$
	12.5 - 18.8	$0.008 * \text{age} + 1.45$
	18.8 - 39.2	$-0.01 * \text{age} + 1.78$
	39.2 - 70	$-0.009 * \text{age} + 1.75$

For each gender group specified in table 3.1, the walking speed should be modelled as a statistical uniform distribution having minimum and maximum values as follows:

Table 3.4 – Walking speed on flat terrain (e.g. corridors)

Population groups – passengers	Walking speed on flat terrain (e.g. corridors)	
	Minimum (m/s)	Maximum (m/s)
Females younger than 30 years	0.93	1.55
Females 30-50 years old	0.71	1.19
Females older than 50 years	0.56	0.94
Females older than 50, mobility impaired (1)	0.43	0.71
Females older than 50, mobility impaired (2)	0.37	0.61
Males younger than 30 years	1.11	1.85
Males 30-50 years old	0.97	1.62
Males older than 50 years	0.84	1.4
Males older than 50, mobility impaired (1)	0.64	1.06
Males older than 50, mobility impaired (2)	0.55	0.91
Population groups – crew	Walking speed on flat terrain (e.g. corridors)	
	Minimum (m/s)	Maximum (m/s)
Crew females	0.93	1.55
Crew males	1.11	1.85

⁶ *Maritime EXODUS V4.0, USER GUIDE AND TECHNICAL MANUAL*, Authors: E R Galea, S Gwynne, P. J. Lawrence, L. Filippidis, D. Blackshields and D. Cooney, CMS Press, May 2003 Revision 1.0, ISBN: 1 904521 38 X.

3.2.4 *Unhindered stair speeds*⁷

Speeds are given on the base of gender, age and travel direction (up and down). The speeds in table 3.5 are those along the inclined stairs. It is expected that all the data above will be updated when more appropriate data and results become available.

Table 3.5 – Walking speed on stairs

Population groups – passengers	Walking speed on stairs (m/s)			
	Stairs down		Stairs up	
	Min.	Max.	Min.	Max.
Females younger than 30 years	0.56	0.94	0.47	0.79
Females 30-50 years old	0.49	0.81	0.44	0.74
Females older than 50 years	0.45	0.75	0.37	0.61
Females older than 50, mobility impaired (1)	0.34	0.56	0.28	0.46
Females older than 50, mobility impaired (2)	0.29	0.49	0.23	0.39
Males younger than 30 years	0.76	1.26	0.5	0.84
Males 30-50 years old	0.64	1.07	0.47	0.79
Males older than 50 years	0.5	0.84	0.38	0.64
Males older than 50, mobility impaired (1)	0.38	0.64	0.29	0.49
Males older than 50, mobility impaired (2)	0.33	0.55	0.25	0.41
Population groups – Crew	Walking speed on stairs (m/s)			
	Stairs down		Stairs up	
	Min.	Max.	Min.	Max.
Crew females	0.56	0.94	0.47	0.79
Crew males	0.76	1.26	0.5	0.84

3.2.5 *Consistency of travel speed*

The unhindered travel speeds of each evacuee on flat terrain and on stairs (down and up) are consistent within the respective ranges specified in tables 3.4 and 3.5.

3.2.6 *Exit flow rate (doors)*

The specific unit flow rate is the number of escaping persons past a point in the escape route per unit time per unit width of the route involved, and is measured in number of persons (p). The specific unit flow rate⁸ for any exit should not exceed 1.33 p/m/s.

3.3 **Category ENVIRONMENTAL**

Static and dynamic conditions of the ship. These parameters will influence the moving speed of persons. Presently no reliable figures are available to assess this effect; therefore, these parameters could not yet be considered. This effect will not be accounted for in the scenarios (cases 1, 2, 3 and 4) until more data has been gathered.

⁷ The maximum unhindered stair speeds are derived from data generated by J. Fruin. *Pedestrian planning and design*, Metropolitan Association of Urban Designers and Environmental Planners, New York, 1971. The study comprises two staircase configurations.

⁸ Value based on data accepted in civil building applications in Japan, the United Kingdom and the United States; this value is also consistent with the simplified evacuation analysis method.

3.4 **Category PROCEDURAL**

For the purposes of the four benchmark cases, it is not required to model any special crew procedures. However, the distribution of the crew for the benchmark cases should be in accordance with 4.

3.5 It is expected that all data provided in paragraphs 3.2 and 3.3 will be updated when more appropriate data and results become available.

4 **Detailed specifications (scenarios) for the 4 cases to be considered**

For the purpose of conducting the evacuation analysis, the following initial distributions of passengers and crew should be considered as derived from chapter 13 of the FSS Code, with the additional indications only relevant for the advanced evacuation analysis. If more detailed data considering the distribution of crew is available, the distribution may deviate from the following specifications:

4.1 **Cases 1 and 3 (night)**

Passengers in cabins with maximum berthing capacity fully occupied; 2/3 of crew members in their cabins; of the remaining 1/3 of crew members:

- .1 50% should be initially located in service spaces;
- .2 25% should be located at their emergency stations and should not be explicitly modelled; and
- .3 25% should be initially located at the assembly stations and should proceed towards the most distant passenger cabin assigned to that assembly station in counterflow with evacuees; once this passenger cabin is reached, these crew are no longer considered in the simulation. The ratio between the passenger and counterflow crew should be the same in each main vertical zone.

4.2 **Cases 2 and 4 (day)**

Public spaces, as defined by SOLAS regulation II-2/3.39, will be occupied to 75% of maximum capacity of the spaces by passengers. Crew will be distributed as follows:

- .1 1/3 of the crew will be initially distributed in the crew accommodation spaces (cabins and crew day spaces);
- .2 1/3 of the crew will be initially distributed in the public spaces;
- .3 the remaining 1/3 should be distributed as follows:
 - .1 50% should be located in service spaces;
 - .2 25% should be located at their emergency duty locations and should not be explicitly modelled; and
 - .3 25% should be initially located at the assembly stations and should proceed towards to the most distant passenger cabin assigned to that assembly station in counterflow with evacuees; once this passenger cabin is reached, these crew are no longer considered in the simulation. The ratio between the passenger and counterflow crew should be the same in each main vertical zone.

5 Procedure for calculating the travel duration T

5.1 The travel duration, both that predicted by models and as measured in reality, is a random quantity due to the probabilistic nature of the evacuation process.

5.2 In total, a minimum of 500 different simulations should be carried out for each of the benchmark cases. This will yield, for each case, a total of at least 500 values of t_A .

5.3 These simulations should be made up of at least 100 different randomly generated populations (within the range of population demographics specified in paragraph 3). Simulations based on each of these different populations should be repeated at least 5 times. If these 5 repetitions produce insignificant variations in the results, the total number of populations analysed should be 500 rather than 100, with only a single simulation performed for each population.

5.4 The minimum number of 500 different simulations can be reduced when a convergence is determined by an appropriate method, such as the one shown in appendix 3. The total number of different simulations should be in this case not less than 50.

5.5 The value of the travel duration for each of cases 1 to 4: the value t_i is taken which is higher than 95% of all the calculated values (i.e. for each of cases 1 to 4, the durations t_A are ranked from lowest to highest and t_i is selected for which 95% of the ranked values are lower).

5.6 The value of the travel duration to comply with the performance standard T is the highest of the four calculated travel durations t_i (one for each of cases 1 to 4).

5.7 The procedure for calculating the travel duration for cases 5 and 6 should be based on the same principles as for cases 1 to 4.

6 Documentation of the simulation model used

6.1 The assumptions made for the simulation should be stated. Assumptions that contain simplifications above those in paragraph 3.2 of the *Guidelines for the advanced evacuation analysis of new and existing passenger ships*, should not be made.

6.2 The documentation of the algorithms should contain:

- .1 the variables used in the model to describe the dynamics, e.g. walking speed and direction of each person;
- .2 the functional relation between the parameters and the variables;
- .3 the type of update, e.g. the order in which the persons move during the simulation (parallel, random sequential, ordered sequential or other);
- .4 the representation of stairs, doors, assembly stations, embarkation stations, and other special geometrical elements and their influence on the variables during the simulation (if there is any) and the respective parameters quantifying this influence; and
- .5 a detailed user guide/manual specifying the nature of the model and its assumptions and guidelines for the correct use of the model and interpretations of results should be readily available.

APPENDIX 2

GUIDANCE ON VALIDATION/VERIFICATION OF EVACUATION SIMULATION TOOLS

1 Software verification is an ongoing activity. For any complex simulation software, verification is an ongoing activity and is an integral part of its life cycle. There are at least four forms of verification that evacuation models should undergo. These are⁹:

- .1 component testing;
- .2 functional verification;
- .3 qualitative verification; and
- .4 quantitative verification.

Component testing

2 Component testing involves checking that the various components of the software perform as intended. This involves running the software through a battery of elementary test scenarios to ensure that the major sub-components of the model are functioning as intended. The following is a non-exhaustive list of suggested component tests that should be included in the verification process.

Test 1: Maintaining set walking speed in corridor

3 One person in a corridor 2 m wide and 40 m long with a walking speed of 1 m/s should be demonstrated to cover this distance in 40 s.

Test 2: Maintaining set walking speed up staircase

4 One person on a stair 2 m wide and a length of 10 m measured along the incline with a walking speed of 1 m/s should be demonstrated to cover this distance in 10 s.

Test 3: Maintaining set walking speed down staircase

5 One person on a stair 2 m wide and a length of 10 m measured along the incline with a walking speed of 1 m/s should be demonstrated to cover this distance in 10 s.

Test 4: Exit flow rate

6 100 persons (p) in a room of size 8 m by 5 m with a 1 m exit located centrally on the 5 m wall. The flow rate over the entire period should not exceed 1.33 p/s.

Test 5: Response duration

7 Ten persons in a room of size 8 m by 5 m with a 1 m exit located centrally on the 5 m wall. Impose response durations as follows uniformly distributed in the range between 10 s and 100 s. Verify that each occupant starts moving at the appropriate time.

⁹ Note: This procedure has been highlighted in ISO document ISO/TR 13387-8:1999.

Test 6: Rounding corners

8 Twenty persons approaching a left-hand corner (see figure 1) will successfully navigate around the corner without penetrating the boundaries.

Test 7: Assignment of population demographics parameters

9 Choose a panel consisting of males 30-50 years old from table 3.4 in the appendix to the *Guidelines for the advanced evacuation analysis of new and existing ships* and distribute the walking speeds over a population of 50 people. Show that the distributed walking speeds are consistent with the distribution specified in the table.

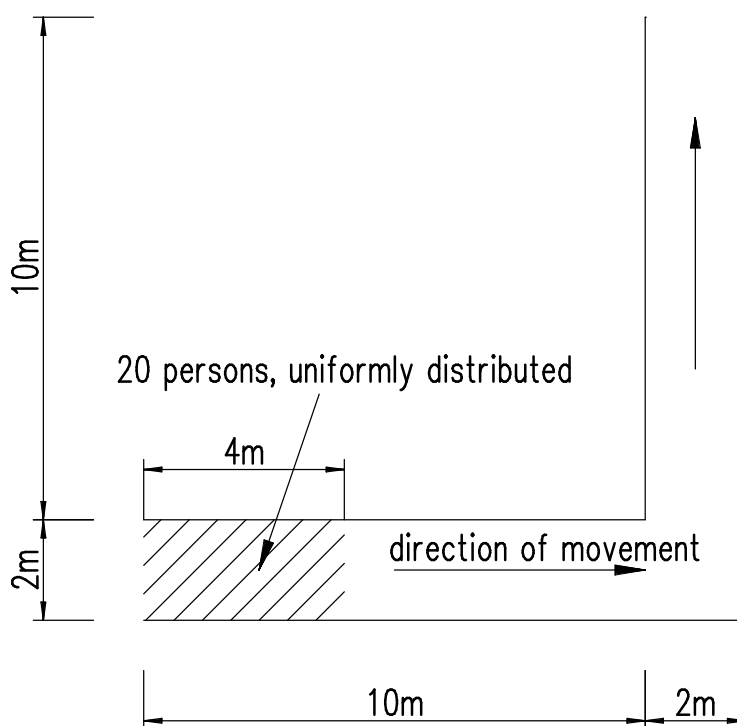

Figure 1: Transverse corridor

Functional verification

10 Functional verification involves checking that the model possesses the ability to exhibit the range of capabilities required to perform the intended simulations. This requirement is task specific. To satisfy functional verification the model developers must set out in a comprehensible manner the complete range of model capabilities and inherent assumptions and give a guide to the correct use of these capabilities. This information should be readily available in technical documentation that accompanies the software.

Qualitative verification

11 The third form of model validation concerns the nature of predicted human behaviour with informed expectations. While this is only a qualitative form of verification, it is nevertheless important, as it demonstrates that the behavioural capabilities built into the model are able to produce realistic behaviours.

Test 8: Counterflow – two rooms connected via a corridor

12 Two rooms 10 m wide and long connected via a corridor 10 m long and 2 m wide starting and ending at the centre of one side of each room. Choose a panel consisting of males 30-50 years old from table 3.4 in the appendix to the *Guidelines for the advanced evacuation analysis of new and existing ships* with instant response time and distribute the walking speeds over a population of 100 persons.

13 Step 1: One hundred persons move from room 1 to room 2, where the initial distribution is such that the space of room 1 is filled from the left with maximum possible density (see figure 2). The time the last person enters room 2 is recorded.

14 Step 2: Step one is repeated with an additional ten, fifty, and one hundred persons in room 2. These persons should have identical characteristics to those in room 1. Both rooms move off simultaneously and the duration for the last persons in room 1 to enter room 2 is recorded. The expected result is that the recorded duration increases with the number of persons in counterflow increases.

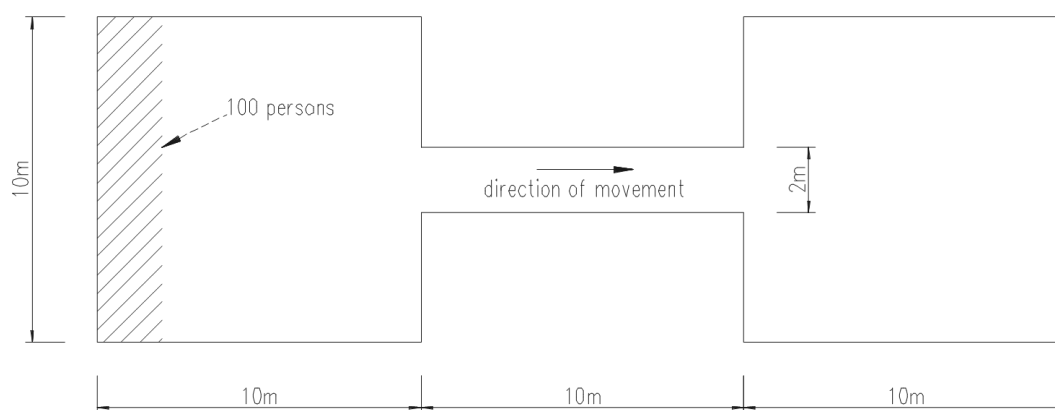

Figure 2: Two rooms connected via a corridor

Test 9: Exit flow: crowd dissipation from a large public room

15 Public room with four exits and 1,000 persons (see figure 3) uniformly distributed in the room. Persons leave via the nearest exits. Choose a panel consisting of males 30-50 years old from table 3.4 in the appendix to the *Guidelines for the advanced evacuation analysis of new and existing ships* with instant response time and distribute the walking speeds over a population of 1,000 persons.

Step 1: Record the amount of time the last person needs to leave the room.

Step 2: Close doors 1 and 2 and repeat step 1.

The expected result is an approximate doubling of the duration to empty the room.

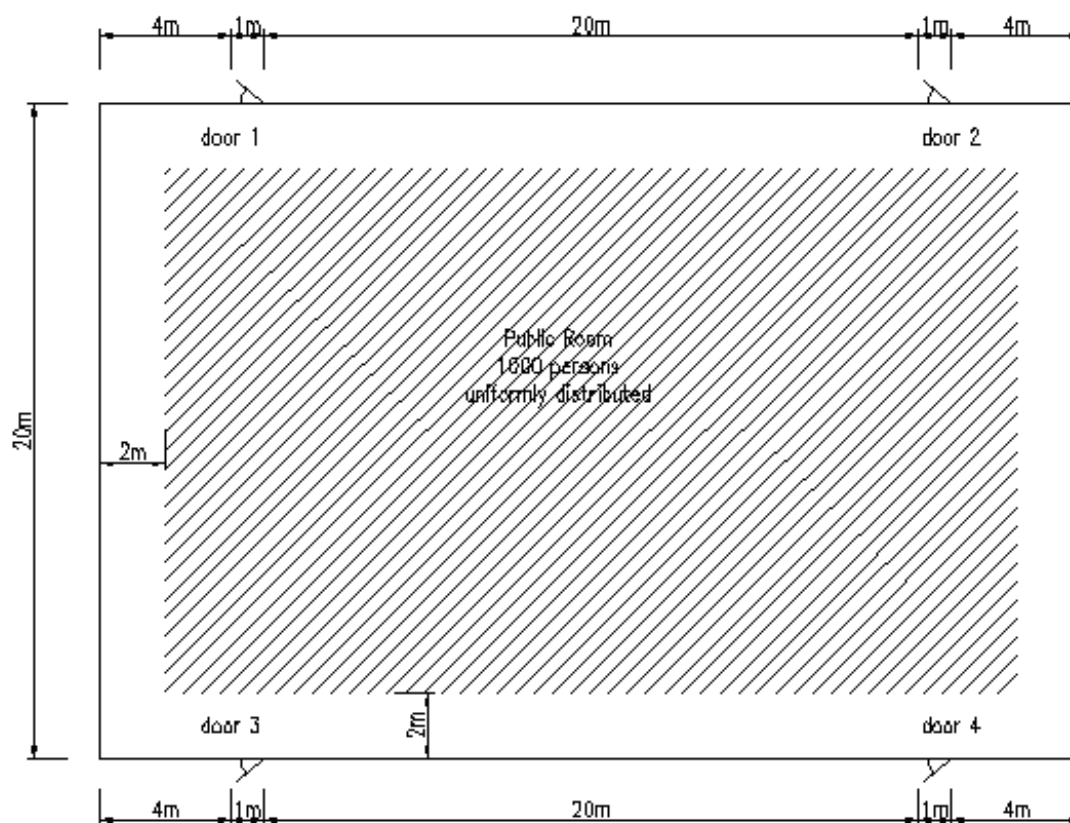

Figure 3: Exit flow from a large public room

Test 10: Exit route allocation

16 Construct a cabin corridor section as shown in figure 4 populated as indicated with a panel consisting of males 30-50 years old from table 3.4 in the appendix to the *Guidelines for the advanced evacuation analysis of new and existing ships* with instant response time and distribute the walking speeds over a population of 23 persons. The people in cabins 1, 2, 3, 4, 7, 8, 9, and 10 are allocated the main exit. All the remaining passengers are allocated the secondary exit. The expected result is that the allocated passengers move to the appropriate exits.

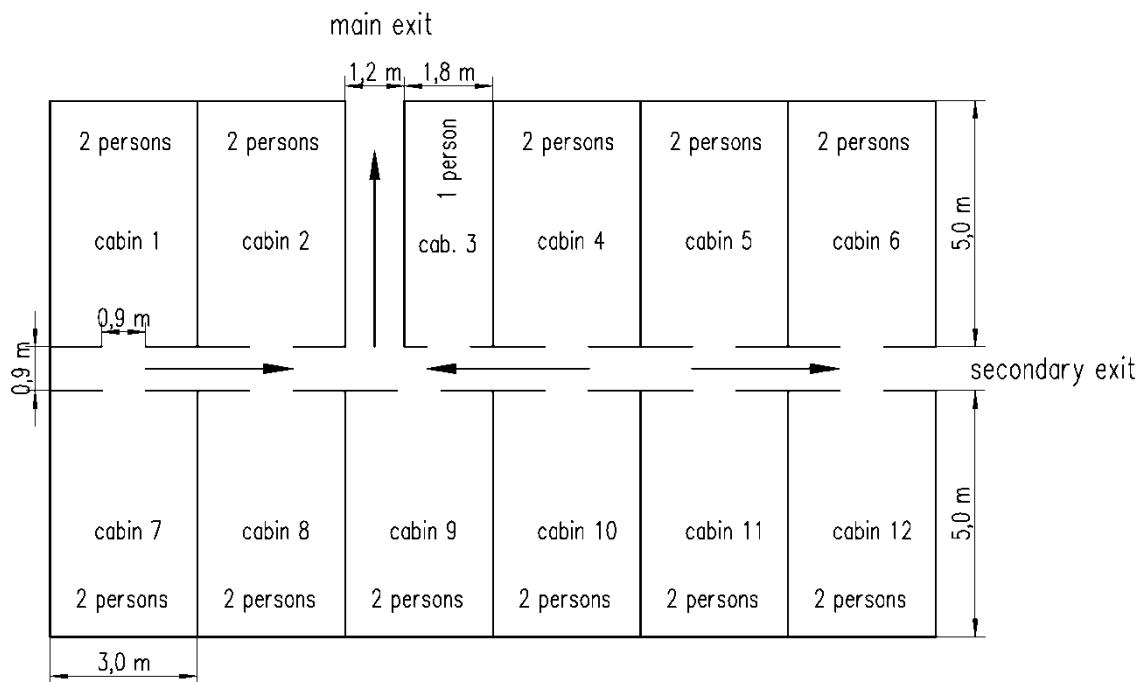

Figure 4: Cabin area

Test 11: Staircase

17 Construct a room connected to a stair via a corridor as shown in figure 5 populated as indicated with a panel consisting of males 30-50 years old from table 3.4 in the appendix to the *Guidelines for the advanced evacuation analysis of new and existing ships* with instant response time and distribute the walking speeds over a population of 150 persons. The expected result is that congestion appears at the exit from the room, which produces a steady flow in the corridor with the formation of congestion at the base of the stairs.

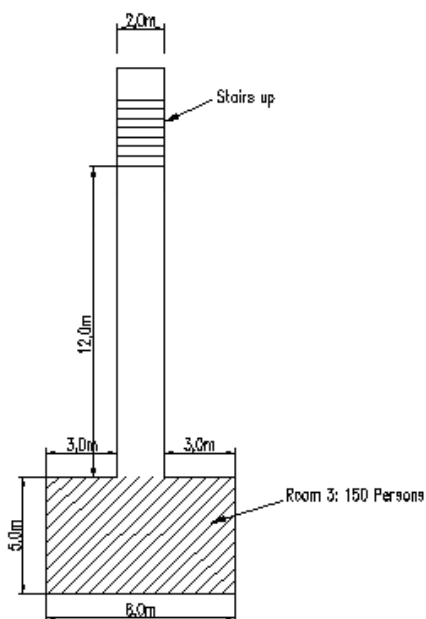

Figure 5: Escape route via stairs

Test 12: Flow density relation

18 The software should be tested for a corridor without any obstructions. It should be demonstrated that the flow of persons in the corridor is generally smaller at very high population densities compared with that at moderate densities.

Quantitative verification

19 Quantitative verification involves comparing model predictions with reliable data generated from evacuation demonstrations. At this stage of development there is insufficient reliable experimental data to allow a thorough quantitative verification of egress models. Until such data becomes available the first three components of the verification process are considered sufficient.

APPENDIX 3

EXAMPLE OF A CONVERGENCE CRITERION

The following process is given as an example of a convergence criterion mentioned in paragraph 5.4 of appendix 1.

1 In total, a minimum of 50 different simulations should be carried out for each of the benchmark cases. This will yield, for each case, a total of at least 50 values of t_A . More than 50 simulations may be required according to the outcome of the convergence test (3 and 4 below), which requires to increment the number of simulations one by one (see 3) and to test the criterion every batch of 50 simulation runs (see 4).

2 These simulations should be made up of at least 10 different randomly generated populations (within the range of population demographics specified in paragraph 3 of appendix 1). Simulations based on each of these different populations should be repeated at least 5 times. If these 5 repetitions produce insignificant variations in the results, the total number of populations analysed should be 50 rather than 10, with only a single simulation performed for each population.

3 Observed 95th centile of t_A

3.1 For each case, the evaluation of the 95th centile is an incremental evaluation which is performed every simulation run using all available t_A previously calculated from the first to the last simulation run of the case studied.

3.2 The value of the 95th centile of all calculated total assembly times (noted $T_{0.95}$) is taken which is higher than 95% of all the previous calculated values (i.e. for each of the four cases, for each simulation run increment, indexed on letter "i" below, all available values of assembly times t_A of the case are ranked from lowest to highest and $T_{0.95}^i$ is selected for which 95% of the ranked values are lower. Consequently, at the simulation number i , there is a series of i values of $T_{0.95}^i$).

4 Convergence criterion

4.1 For each case, the convergence test is an evaluation of the following criterion which is performed every batch of 50 simulation runs. N denotes the number of simulations that have been run every time the criterion is tested (i.e. $N = 50$ for the first batch, $N = 100$ for the second batch etc.)

4.2 The distance between the maximum to the minimum of $T_{0.95}^i$ obtained over the 50 last simulation increments should not exceed the distance (in absolute value) of the mean of $T_{0.95}^i$ over the 50 last simulation increments, to the maximum allowable assembly time (T_{lim}):

$$|T_{lim} - T_{0.95}^{mean50}| \geq T_{0.95}^{max50} - T_{0.95}^{min50}$$

Where:

$$T_{lim} = \frac{n - \frac{2}{3}(E+L)}{1.25} \text{ with } n, E, \text{ and } L, \text{ as defined in Annex1, §5.1 (1),}$$

$$T_{0.95}^{mean50} = \text{mean}(T_{0.95}^i), \text{ with } i \text{ between } (N - 49) \text{ and } N,$$

$$T_{0.95}^{max50} = \text{maximum}(T_{0.95}^i), \text{ with } i \text{ between } (N - 49) \text{ and } N, \text{ and}$$

$$T_{0.95}^{min50} = \text{minimum}(T_{0.95}^i), \text{ with } i \text{ between } (N - 49) \text{ and } N.$$

4.3 For each of the four cases, the following iterative method should be followed to determine the travel Time T_{case} :

- If the criterion is not met, another batch of 50 simulations should be run;
- If the criterion is met, sufficient number of simulations has been run for the case. $T_{0.95}^{\text{mean}50}$ (for the first N which satisfies the criterion) is selected as the travel time T_{case} ; and
- If a total of 500 simulations have been run for the case, the process should be stopped and $T_{0.95}^{\text{mean}50}$ is selected as the travel time T_{case} .

5 The value of the travel time to comply with the performance standard T is the highest of the four calculated travel times T_{case} (one for each of the four cases).

6 The same procedure for a convergence criterion for case 5 and the travel duration in case 6 (travel duration from assembly stations to the LSA entry points) can be based on the same principle (paragraph 1 to 5). For case 6, the procedure requires to adapt the notations (t_A) and to take into account $(E+L) \leq 30'$ (see annex 1, paragraph 5.1 (2) for the definition of T_{lim}).

4 ALBERT EMBANKMENT
LONDON SE1 7SR
Telephone: +44 (0)20 7735 7611 Fax: +44 (0)20 7587 3210

MSC.1/Circ.1534
6 June 2016

**UNIFIED INTERPRETATIONS RELATING TO THE INTERNATIONAL
CONVENTION ON LOAD LINES, 1966**

1 The Maritime Safety Committee, at its ninety-sixth session (11 to 20 May 2016), in order to facilitate global and consistent implementation of the requirements of the 1966 Load Lines Convention, approved unified interpretations relating to the International Convention on Load Lines, 1966, prepared by the Sub-Committee on Ship Design and Construction, at its third session (18 to 22 January 2016), as set out in the annex.

2 Member States are invited to apply the annexed unified interpretations and to bring them to the attention of all parties concerned.

ANNEX

UNIFIED INTERPRETATIONS RELATING TO THE INTERNATIONAL CONVENTION ON LOAD LINES, 1966

Regulation 13 – Position of hatchways, doorways and ventilators

1 For the purpose of these regulations, two positions of hatchways, doorways and ventilators are defined as follows:

Position 1 – Upon freeboard decks and raised quarterdecks, or other exposed decks* lower than one standard height of superstructure above the freeboard deck, and upon exposed decks* situated forward of a point located a quarter of the ship's length from the forward perpendicular that are located lower than two standard heights of superstructure above the freeboard deck.

Position 2 – Upon exposed decks* situated abaft a quarter of the ship's length from the forward perpendicular and located at least one standard height of superstructure above the freeboard deck and lower than two standard heights of superstructure above the freeboard deck.

Upon exposed decks* situated forward of a point located a quarter of the ship's length from the forward perpendicular and located at least two standard heights of superstructure above the freeboard deck and lower than three standard heights of superstructure above the freeboard deck.

Regulation 20 – Air pipes

2 Where air pipes to ballast and other tanks extend above:

- .1 the freeboard deck; or
- .2 other exposed decks* lower than two standard heights of superstructure above the freeboard deck,

the exposed parts of the pipes should be of substantial construction, and the height from the deck to the point where water may have access below should be at least:

- .1 760 mm on the freeboard deck or other exposed decks* lower than one standard height of superstructure above the freeboard deck; and
- .2 450 mm on other exposed decks* lower than two standard heights of superstructure above freeboard deck.

Note: Flush bolted access covers, which are of substantial construction and are secured by gaskets and closely spaced bolts to maintain water tightness, are not subject to the minimum sill height requirements.

* "Exposed decks" include top decks of superstructures, deckhouses, companionways and other similar deck structures.

Regulation 27 – Types of ships

Regulation 27(13)(e)

3 Unprotected openings include ventilators (complying with regulation 19(4) of the International Convention on Load Lines, 1966) that for operational reasons have to remain open to supply air to the engine room or emergency generator room (if the same is considered buoyant in the stability calculation or protecting openings leading below) for the effective operation of the ship.

4 ALBERT EMBANKMENT
LONDON SE1 7SR
Telephone: +44 (0)20 7735 7611 Fax: +44 (0)20 7587 3210

MSC.1/Circ.1536
6 June 2016

UNIFIED INTERPRETATIONS OF SOLAS REGULATIONS II-1/29.3 AND II-1/29.4

1 The Maritime Safety Committee, at its ninety-sixth session (11 to 20 May 2016), with a view to providing more specific guidance on the application of the provisions of SOLAS regulations II-1/29.3 and 29.4 concerning the steering gear test, approved the unified interpretations of SOLAS regulations II-1/29.3 and II-1/29.4, prepared by the Sub-Committee on Ship Design and Construction, at its third session (18 to 22 January 2016), as set out in the annex.

2 Member States are invited to apply the annexed unified interpretations from 13 May 2016 when applying the relevant provisions of SOLAS regulations II-1/29.3 and II-1/29.4 and to bring them to the attention of all parties concerned.

3 This circular supersedes MSC.1/Circ.1425.

ANNEX

UNIFIED INTERPRETATIONS OF SOLAS REGULATIONS II-1/29.3 AND II-1/29.4

Regulation II-1/29 – Steering gear

1 In order for ships to comply with the performance requirements stated in regulations II-1/29.3.2 and 29.4.2, they are to have steering gear capable of meeting these performance requirements when at their deepest seagoing draught.

2 In order to demonstrate this ability, the trials may be conducted in accordance with section 6.1.5.1 of the standard ISO 19019:2005 (Sea-going vessels and marine technology – Instructions for planning, carrying out and reporting sea trials).

3 On all occasions when trials are conducted with the vessel not at the deepest seagoing draught, the loading condition can be accepted on the conditions that either:

- .1 The rudder is fully submerged (at zero speed waterline) and the vessel is in an acceptable trim condition.
- .2 The rudder torque at the trial loading condition has been reliably predicted (based on the system pressure measurement) and extrapolated to the maximum seagoing draught condition using the following method to predict the equivalent torque and actuator pressure at the deepest seagoing draught:

$$Q_F = Q_T \alpha$$
$$\alpha = 1.25 \left(\frac{A_F}{A_T} \right) \left(\frac{V_F}{V_T} \right)^2$$

where:

α is the Extrapolation factor.

Q_F is the rudder stock moment (torque in the rudder stock) for the deepest service draught and maximum service speed condition.

Q_T is the rudder stock moment (torque in the rudder stock) for the trial condition.

A_F is the total immersed projected area of the movable part of the rudder in the deepest seagoing condition.

A_T is the total immersed projected area of the movable part of the rudder in the trial condition.

V_F is the contractual design speed of the vessel corresponding to the maximum continuous revolutions of the main engine at the deepest seagoing draught.

V_T is the measured speed of the vessel (considering current) in the trial condition.

Where the rudder actuator system pressure is shown to have a linear relationship to the rudder stock torque the above equation can be taken as:

$$P_F = P_T \alpha$$

where:

P_F is the estimated steering actuator hydraulic pressure in the deepest seagoing draught condition.

P_T is the maximum measured actuator hydraulic pressure in the trial condition.

Where constant volume fixed displacement pumps are utilized then the regulations can be deemed satisfied if the estimated steering actuator hydraulic pressure at the deepest draught is less than the specified maximum working pressure of the rudder actuator. Where a variable delivery pump is utilized pump data should be supplied and interpreted to estimate the delivered flow rate corresponds to the deepest seagoing draught in order to calculate the steering time and allow it to be compared to the required time.

Where A_T is greater than $0.95A_F$ there is no need for extrapolation methods to be applied.

- .3 Alternatively, the designer or builder may use computational fluid dynamic (CFD) studies or experimental investigations to predict the rudder stock moment at the full seagoing draught condition and service speed. These calculations or experimental investigations should be to the satisfaction of the Administration.

- 4 In any case for the main steering gear trial, the speed of the ship corresponding to the number of maximum continuous revolution of main engine and maximum design pitch applies.

4 ALBERT EMBANKMENT
LONDON SE1 7SR
Telephone: +44 (0)20 7735 7611 Fax: +44 (0)20 7587 3210

MSC.1/Circ.1539
6 June 2016

UNIFIED INTERPRETATIONS OF SOLAS CHAPTER II-1

1 The Maritime Safety Committee, at its ninety-sixth session (11 to 20 May 2016), in order to facilitate global and consistent implementation of the requirements of SOLAS chapter II-1, approved unified interpretations of SOLAS chapter II-1, prepared by the Sub-Committee on Ship Design and Construction, at its third session (18 to 22 January 2016), as set out in the annex.

2 Member States are invited to apply the annexed unified interpretations and to bring them to the attention of all parties concerned.

ANNEX

UNIFIED INTERPRETATIONS OF SOLAS CHAPTER II-1

Regulation 2.21 – Definition of the term "Lightweight"

1 The weight of mediums on board for the fixed firefighting systems (e.g. freshwater, CO₂, dry chemical powder, foam concentrate, etc.) should be included in the lightweight and lightship condition.

Regulation 3-2 – Protective coatings of dedicated seawater ballast tanks in all types of ships and double-side skin spaces of bulk carriers

2 The following tanks should not be considered to be dedicated seawater ballast tanks and should, therefore, be exempted from the application and requirements of the *Performance standard for protective coatings for dedicated seawater ballast tanks in all types of ships and double-side skin spaces of bulk carriers* (resolution MSC.215(82)), provided the coatings applied in the tanks described in subparagraphs .2 and .3 below are confirmed by the coating manufacturer to be resistant to the media stored in these tanks and provided such coatings are applied and maintained according to the coating manufacturer's procedures.

- .1 ballast tanks identified as "Spaces included in Net Tonnage" in the International Tonnage Certificate (1969);
- .2 seawater ballast tanks in passenger ships also designated for the carriage of grey water or black water; and
- .3 seawater ballast tanks in livestock carriers also designated for the carriage of livestock dung.

Regulation 7-2 – Calculation of the factor s_i

3 In applying θ_v , openings which cannot be or are incapable of being closed weathertight include ventilators (complying with regulation 19(4) of the *International Convention on Load Lines, 1966*) that for operational reasons have to remain open to supply air to the engine room or emergency generator room (if the same is considered buoyant in the stability calculation or protecting openings leading below) for the effective operation of the ship.

4 ALBERT EMBANKMENT
LONDON SE1 7SR
Telephone: +44 (0)20 7735 7611 Fax: +44 (0)20 7587 3210

MSC.1/Circ.1545
6 June 2016

**UNIFIED INTERPRETATIONS RELATING TO THE APPLICATION OF SOLAS
REGULATION II-1/3-6, AS AMENDED, AND THE REVISED TECHNICAL
PROVISIONS FOR MEANS OF ACCESS FOR INSPECTIONS
(RESOLUTION MSC.158(78))**

1 The Maritime Safety Committee, at its ninety-sixth session (11 to 20 May 2016), approved the Unified interpretations relating to the application of SOLAS regulation II-1/3-6, as amended, and the *Revised technical provisions for means of access for inspections* (resolution MSC.158(78)), prepared by the Sub-Committee on Ship Design and Construction, at its third session (18 to 22 January 2016), as set out in the annex, with a view to ensuring a uniform approach towards the application of the provisions of SOLAS regulation II-1/3-6.

2 Member States are invited to use the annexed unified interpretations when applying the relevant provisions of SOLAS regulation II-1/3-6, as amended, and to bring them to the attention of all parties concerned.

ANNEX

UNIFIED INTERPRETATIONS RELATING TO THE APPLICATION OF SOLAS REGULATION II-1/3-6, AS AMENDED, AND THE REVISED TECHNICAL PROVISIONS FOR MEANS OF ACCESS FOR INSPECTIONS (RESOLUTION MSC.158(78))

Revised technical provisions for means of access for inspections (resolution MSC.158(78)), paragraphs 3.13.2 and 3.13.6

Adjacent sections of vertical ladder need to be installed so that the following provisions are complied with:

- the minimum "lateral offset" between two adjacent sections of vertical ladder, is the distance between the sections, upper and lower, so that the adjacent stringers are spaced of at least 200 mm, measured from half thickness of each stringer.
- adjacent sections of vertical ladder should be installed so that the upper end of the lower section is vertically overlapped, in respect to the lower end of the upper section, to a height of 1500 mm in order to permit a safe transfer between ladders.
- no section of the access ladder should be terminated directly or partly above an access opening.

Figure "A"

Vertical Ladder – Ladder through the linking platform

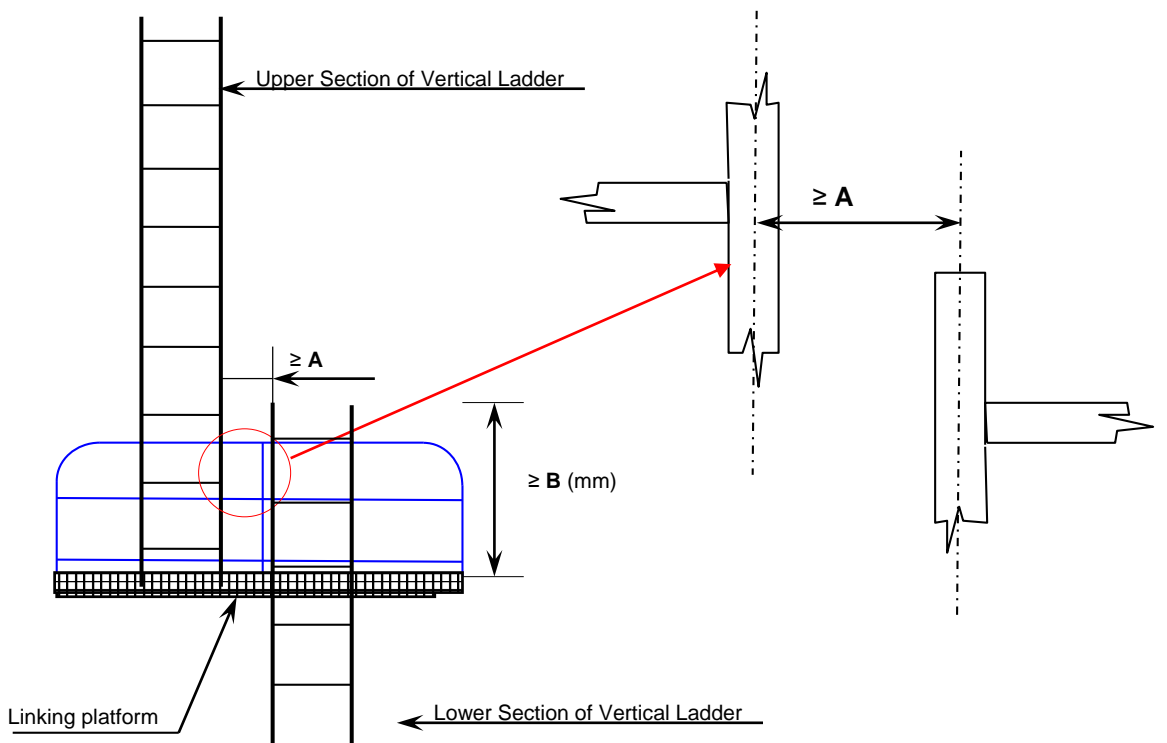

Dimension		
A	Horizontal separation between two vertical ladders, stringer to stringer	≥ 200 mm
B	Stringer height above landing or intermediate platform	$\geq 1500^*$ mm
C	Horizontal separation between ladder and platform	$100 \text{ mm} \leq C < 300 \text{ mm}$
* The minimum height of the handrail of resting platform is 1000 mm (Technical Provision, resolution MSC.158(78), paragraph 3.3)		

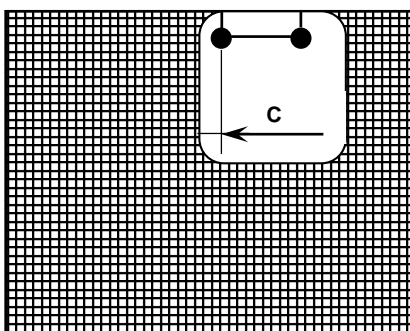
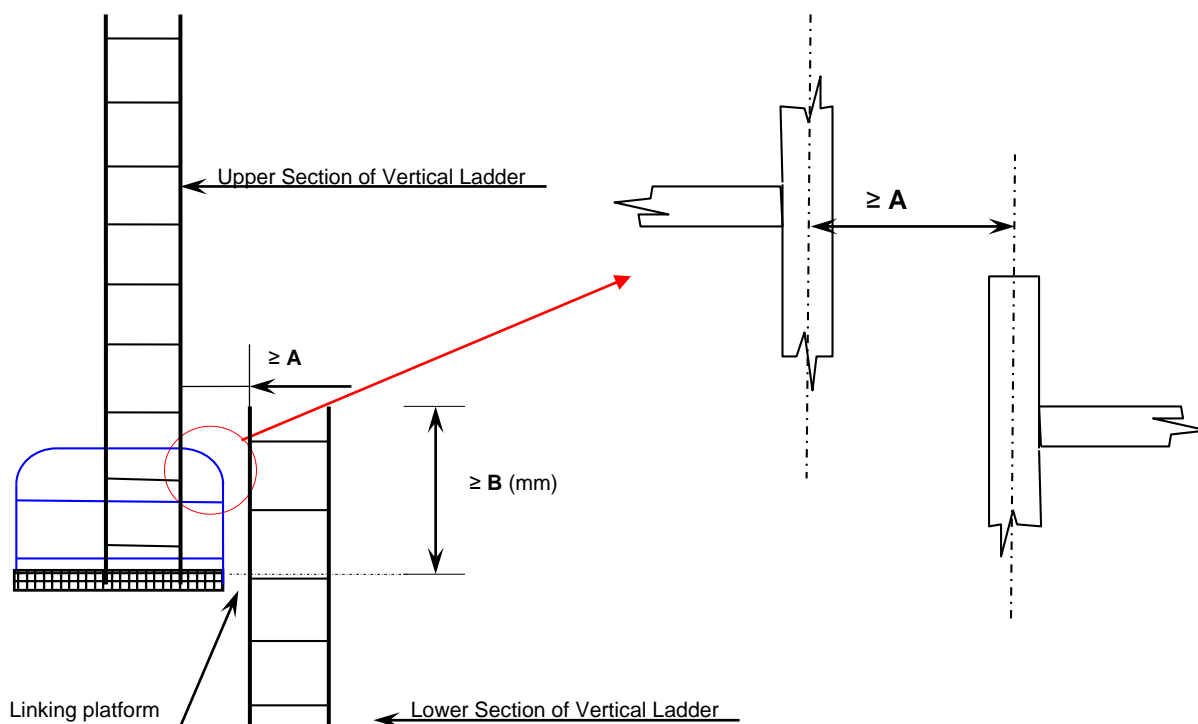
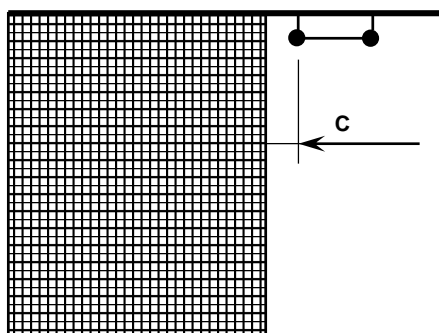

Figure "B"

Vertical Ladder – Side mount



Dimension		
A	Horizontal separation between two vertical ladders, stringer to stringer	≥ 200 mm
B	Stringer height above landing or intermediate platform	$\geq 1500^*$ mm
C	Horizontal separation between ladder and platform	$100 \text{ mm} \leq C < 300 \text{ mm}$
* The minimum height of the handrail of resting platform is 1000 mm (Technical Provision, resolution MSC.158(78), paragraph 3.3)		



4 ALBERT EMBANKMENT
LONDON SE1 7SR
Telephone: +44 (0)20 7735 7611 Fax: +44 (0)20 7587 3210

MSC.1/Circ.1547
9 June 2016

**GUIDANCE ON THE APPLICATION OF SOLAS REGULATION II-1/3-12
TO SHIPS DELIVERED BEFORE 1 JULY 2018**

1 The Maritime Safety Committee (MSC), at its ninety-sixth session (11 to 20 May 2016), approved draft amendments to SOLAS regulation II-1/3-12 in order to clarify the application of the aforementioned regulation.

2 In this regard, MSC 96, with a view to providing, in the interim period following approval and until the amendment enters into force, guidance on the application of SOLAS regulation II-1/3-12, as provided in resolution MSC.338(91), to ships for which the building contract is placed before 1 July 2014, the keels of which are laid or which are at a similar stage of construction on or after 1 January 2015 and delivered before 1 July 2018, approved the following guidance:

On ships:

- .1 for which the building contract is placed before 1 July 2014; and
- .2 the keels of which are laid or which are at a similar stage of construction on or after 1 January 2015; and
- .3 the delivery of which is before 1 July 2018,

measures* should be taken to reduce machinery noise in machinery spaces to acceptable levels as determined by the Administration. If this noise cannot be sufficiently reduced the source of excessive noise should be suitably insulated or isolated or a refuge from noise should be provided if the space is required to be manned. Ear protectors should be provided for personnel required to enter such spaces, if necessary.

3 Member States are invited to use the above guidance when applying the relevant provisions of SOLAS regulation II-1/3-12 and to bring it to the attention of all parties concerned.

* Refer to the *Code on noise levels on board ships* (resolution A.468(XII)).